



US00D417984S

United States Patent [19] Sand

[11] Patent Number: Des. 417,984

[45] Date of Patent: ** Dec. 28, 1999

[54] SEAT CUSHION

[75] Inventor: Tore Sand, Hedensted, Denmark

[73] Assignee: Dan-Foam A/S, Aarup, Denmark

[**] Term: 14 Years

[21] Appl. No.: 29/094,416

[22] Filed: Oct. 1, 1998

[30] Foreign Application Priority Data

Apr. 1, 1998 [DK] Denmark 0363-1998

[51] LOC (6) Cl. 06-01

[52] U.S. Cl. D6/500; D6/368

[58] Field of Search D6/601, 334, 335,
D6/336, 368, 500, 501, 502, 596; 297/4,
382

[56] References Cited

U.S. PATENT DOCUMENTS

| | | | | |
|------------|---------|--------------|-------|--------|
| D. 258,482 | 3/1981 | Strock | | D6/596 |
| D. 293,282 | 12/1987 | Ashford | | D6/502 |
| D. 329,148 | 9/1992 | Hwang et al. | | D6/502 |
| D. 360,308 | 7/1995 | Smith et al. | | D6/368 |
| D. 360,768 | 8/1995 | Hwang et al. | | D6/368 |
| D. 366,383 | 1/1996 | Briegleb | | D6/601 |
| D. 379,047 | 5/1997 | Richard | | D6/601 |

| | | | | |
|-----------|--------|---------------|-------|--------|
| 2,792,875 | 5/1957 | Pirrone | | D6/368 |
| 4,824,171 | 4/1989 | Hollingsworth | | D6/368 |
| 4,843,662 | 7/1989 | Handelman | | D6/601 |

OTHER PUBLICATIONS

192 Gateway/Teal, p. 68, Lyon-Shaw, outdoor furniture box, 1990-91.

Primary Examiner—Doris V. Coles

Assistant Examiner—Mimosa De

Attorney, Agent, or Firm—Sixbey, Friedman, Leedom & Ferguson; David S. Safran

[57] CLAIM

The ornamental design for a seat cushion, as shown.

DESCRIPTION

FIG. 1 is a front perspective view as seen from above and to one side showing my design;

FIG. 2 is a rear perspective view as seen from above and to one side showing my design;

FIG. 3 is a left side elevational view of the design;

FIG. 4 is a right side elevational view of the design;

FIG. 5 is a top plan view of the design;

FIG. 6 is a front elevational view of the design;

FIG. 7 is a rear elevational view of the design; and,

FIG. 8 is a bottom plan view of my design.

1 Claim, 3 Drawing Sheets

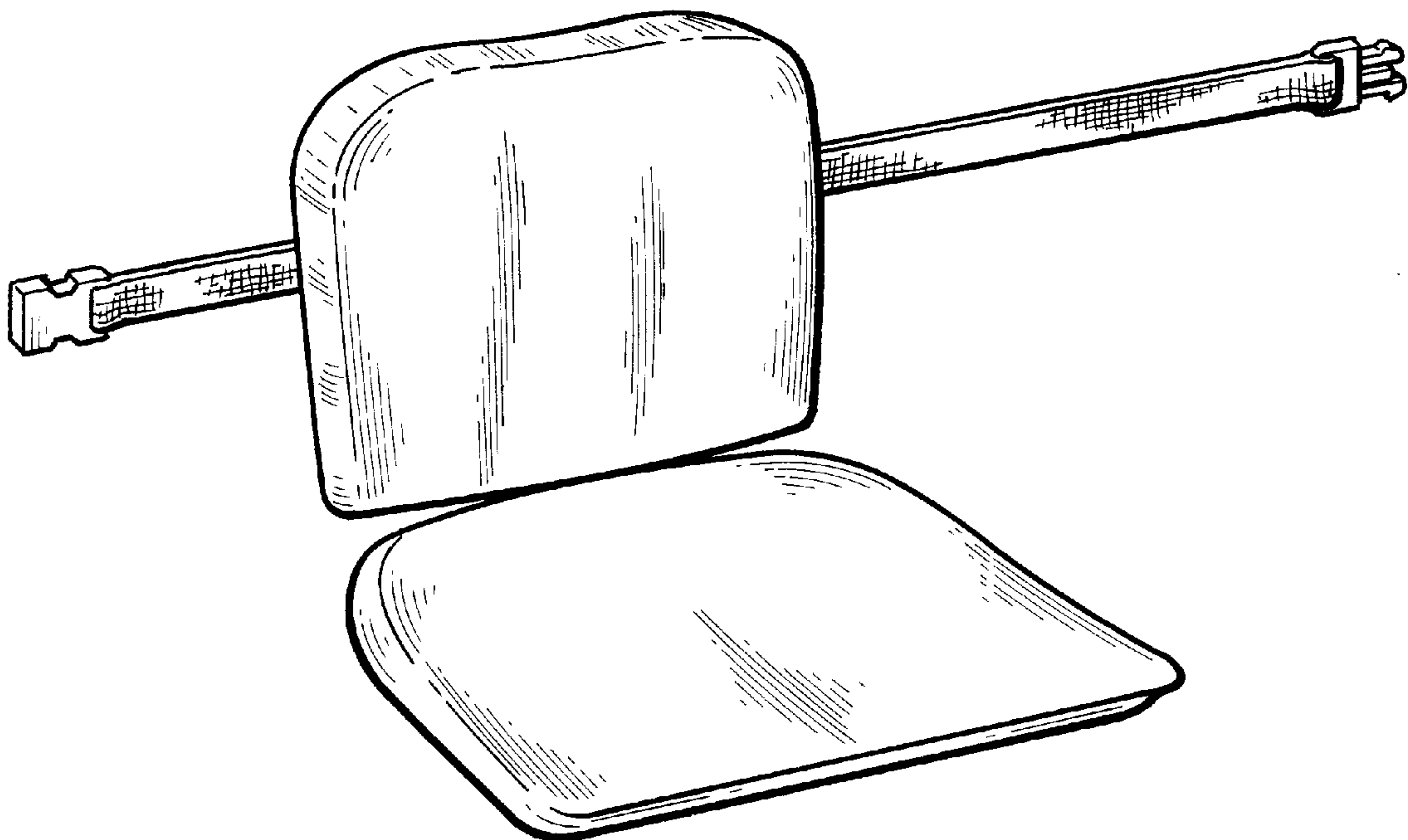

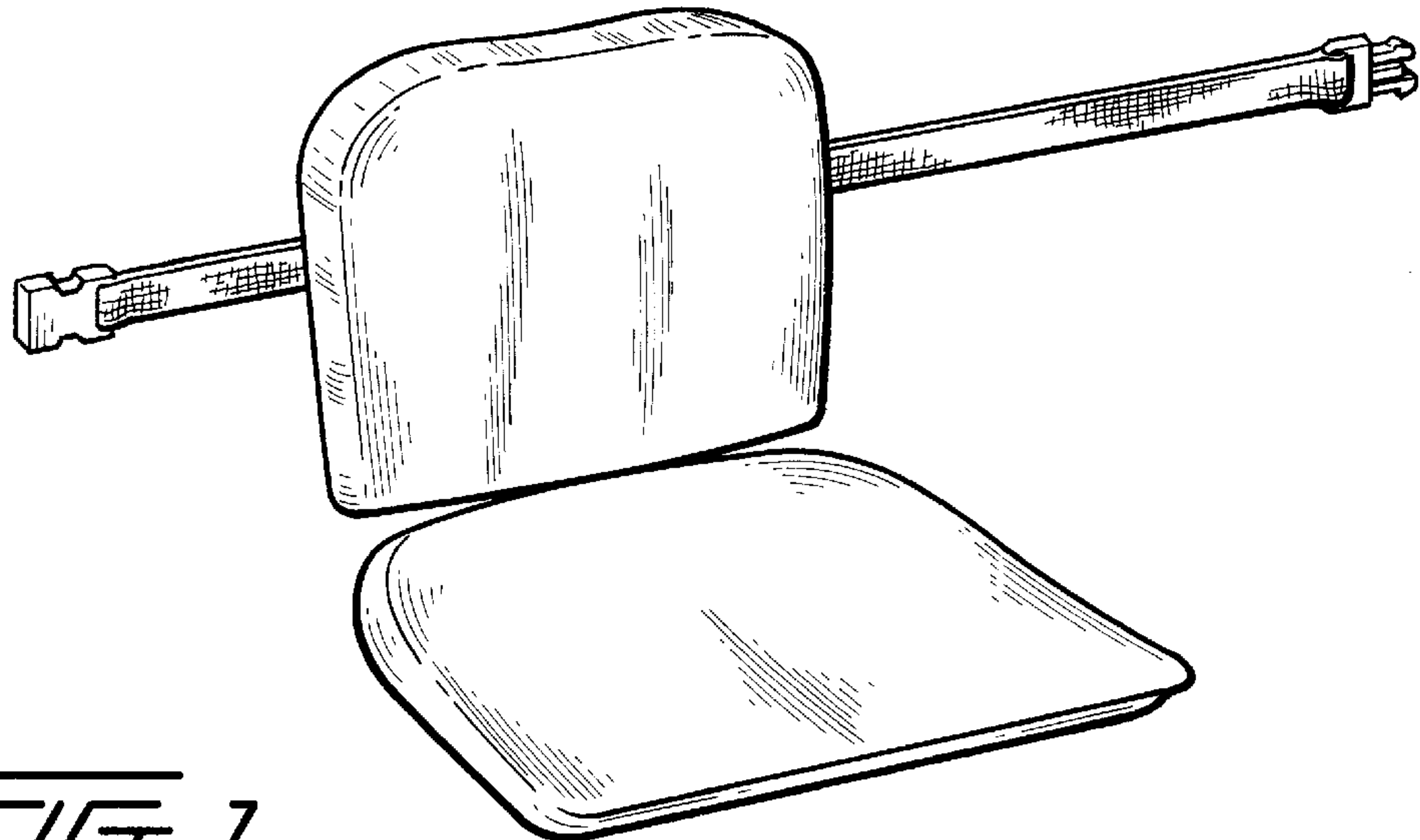

FIG. 1

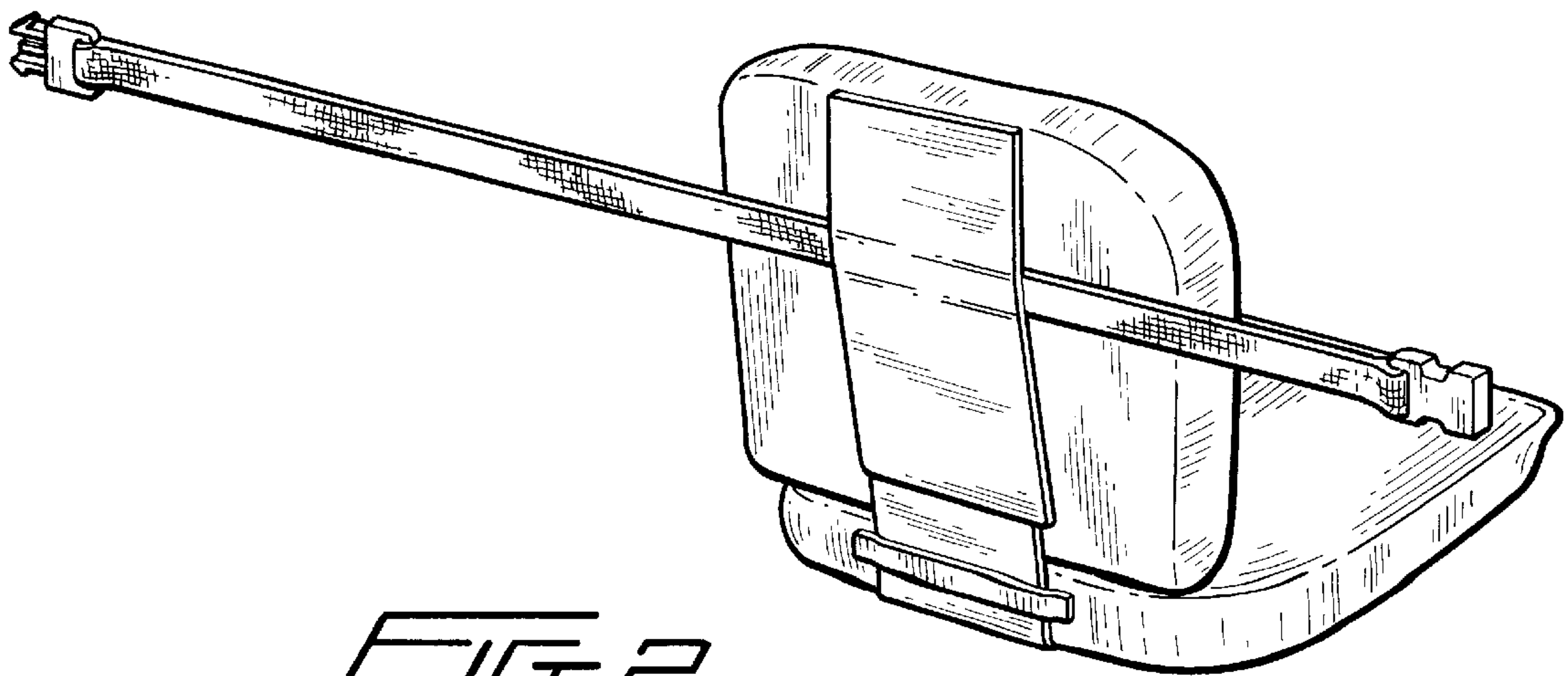

FIG. 2

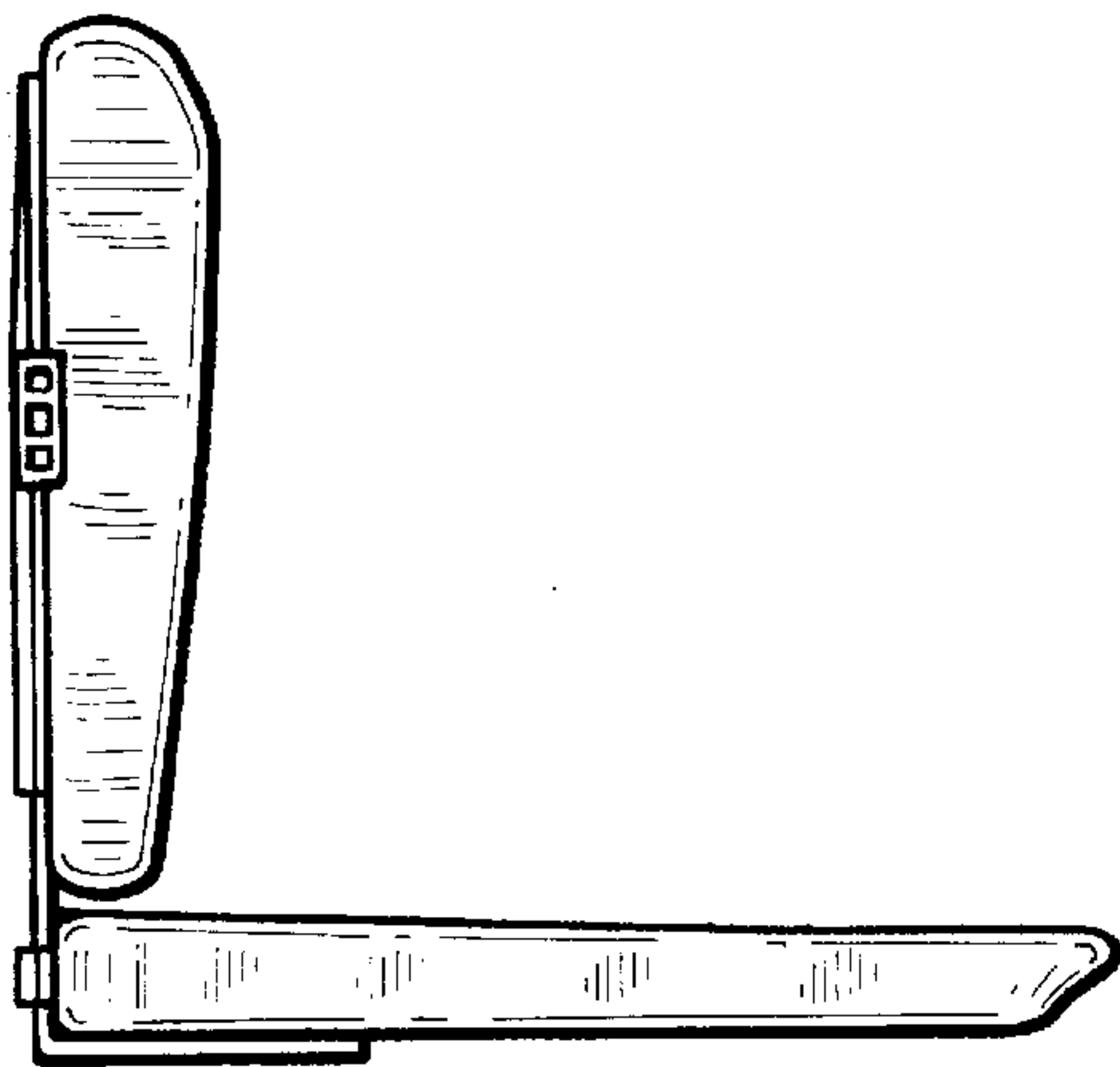

FIG. 3

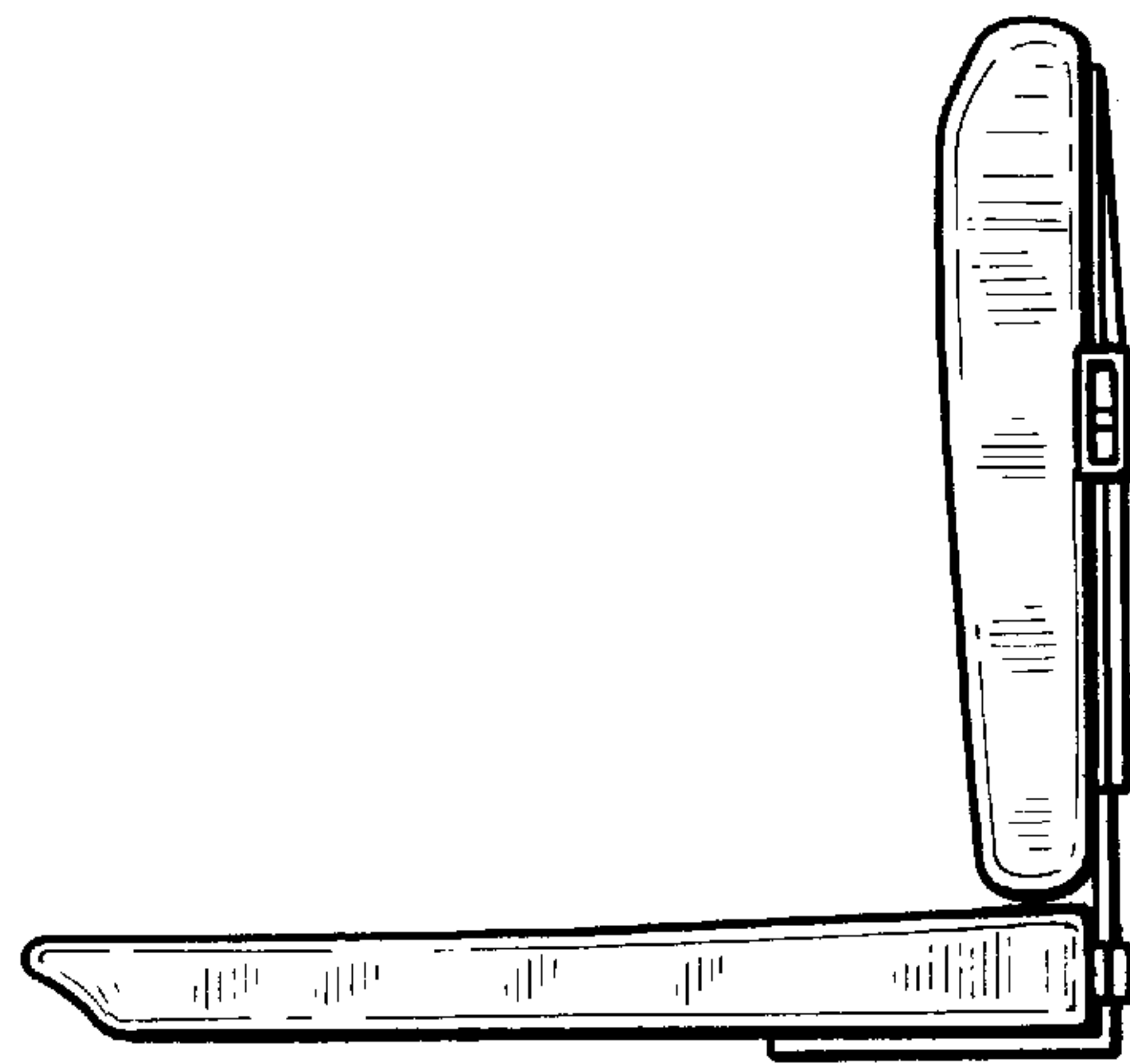

FIG. 4

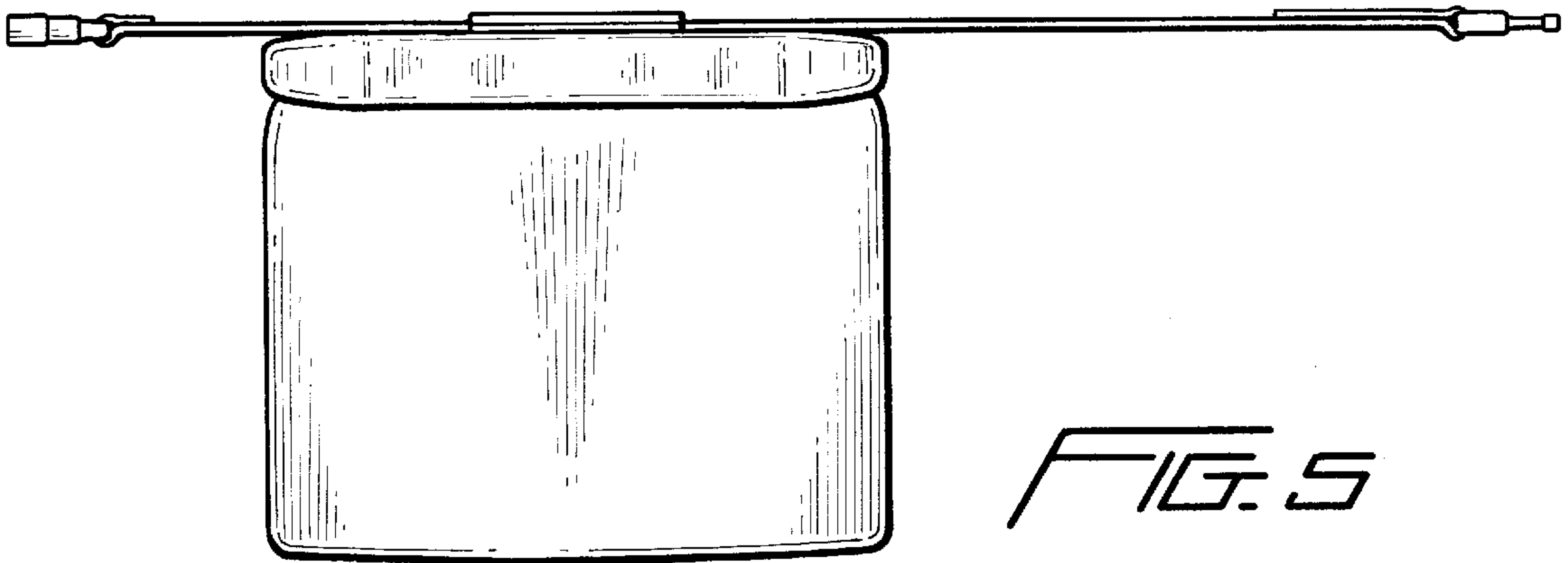

FIG. 5

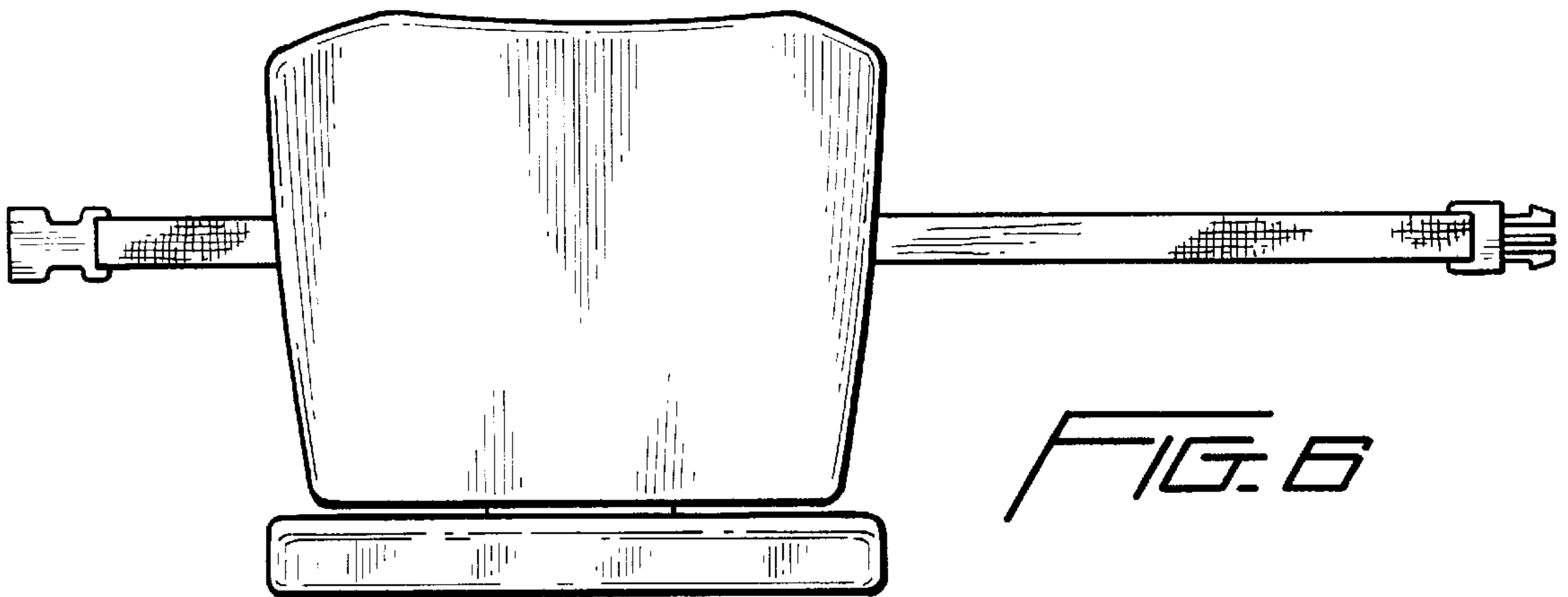

FIG. 6

