



US00D417971S

United States Patent [19]

Natuzzi et al.

[11] Patent Number: **Des. 417,971**

[45] Date of Patent: **** Dec. 28, 1999**

[54] SEAT

[75] Inventors: **Pasquale Natuzzi; Raffaella Lucarelli**, both of Santeramo In Colle, Italy

[73] Assignee: **Industrie Natuzzi, Spa**, Bari, Italy

[**] Term: **14 Years**

[21] Appl. No.: **29/076,650**

[22] Filed: **Sep. 15, 1997**

[51] LOC (6) Cl. **06-01**

[52] U.S. Cl. **D6/381; D6/334; D6/335**

[58] Field of Search D6/334, 335, 336, D6/364, 371, 373, 377, 500, 501, 502; 297/232, 445, 446

[56] References Cited

U.S. PATENT DOCUMENTS

D. 265,869	8/1982	Lüthy	D6/381
D. 284,145	6/1986	Staats et al.	D6/381
D. 293,283	12/1987	Formenti	D6/381
D. 361,909	9/1995	Natuzzi et al.	D6/381
D. 363,388	10/1995	Natuzzi et al.	D6/381
D. 365,457	12/1995	Natuzzi et al.	D6/381
D. 369,475	5/1996	Natuzzi et al.	D6/335
D. 369,480	5/1996	Natuzzi et al.	D6/381
D. 374,355	10/1996	Natuzzi et al.	D6/381
D. 382,130	8/1997	Natuzzi et al.	D6/381
D. 390,373	2/1998	Natuzzi et al.	D6/381
4,848,839	7/1989	Galando	D6/381 X

OTHER PUBLICATIONS

Natuzzi Model 1100, Sofa Photo and Schematics, International Home Furnishings Market, High Point, N.C., Oct. 1993.

Rowe, p. 8, Sofa second from bottom at left, 1995 (2nd ed).

Natuzzi Model 184, Apr. 1987, at International Home Furnishings Market in High Point, North Carolina.

Natuzzi Model 450, Oct. 1988, at International Home Furnishings Market in High Point, North Carolina.

Natuzzi Model 462, Oct. 1988, at International Home Furnishings Market in High Point, North Carolina.

Natuzzi Model 464, Apr. 1989, at International Home Furnishings Market in High Point, North Carolina.

Natuzzi Model 600/601, Oct. 1987, at International Home Furnishings Market in High Point, North Carolina.

Natuzzi Model 612, Apr. 1988, at International Home Furnishings Market in High Point, North Carolina.

Natuzzi Model 619, Oct. 1988, at International Home Furnishings Market in High Point, North Carolina.

Natuzzi Model 621, Oct. 1988, at International Home Furnishings Market in High Point, North Carolina.

Natuzzi Model 827, Apr. 1991, at International Home Furnishings Market in High Point, North Carolina.

Natuzzi Model 924, Apr. 1992, at International Home Furnishings Market in High Point, North Carolina.

(List continued on next page.)

Primary Examiner—Gary D. Watson

Attorney, Agent, or Firm—Alston & Bird LLP

[57] CLAIM

The ornamental design for a seat, as shown and described.

DESCRIPTION

FIG. 1 is a front perspective view of a seat showing our new design in the form of a sofa;

FIG. 2 is a front elevational view thereof;

FIG. 3 is a top plan view thereof;

FIG. 4 is a right side elevational view, the left side being a mirror image thereof;

FIG. 5 is a rear perspective view thereof;

FIG. 6 is a front elevational view of a seat showing our new design in the form of a loveseat;

FIG. 7 is a front elevational view of a seat showing our new design in the form of a chair;

FIG. 8 is a front perspective view of a seat showing our new design in the form of a sectional;

FIG. 9 is a top plan view thereof; and,

FIG. 10 is a rear perspective view thereof.

The broken lines shown herein are for illustrative purposes only and form no part of the claimed design.

The rear views of FIGS. 6 and 7 are like FIG. 5, the difference being a matter of length.

The end views of FIGS. 6 and 7 are like that shown in FIG. 4.

FIGS. 1 and 5 are shown on an enlarged scale relative to the other views.

1 Claim, 6 Drawing Sheets

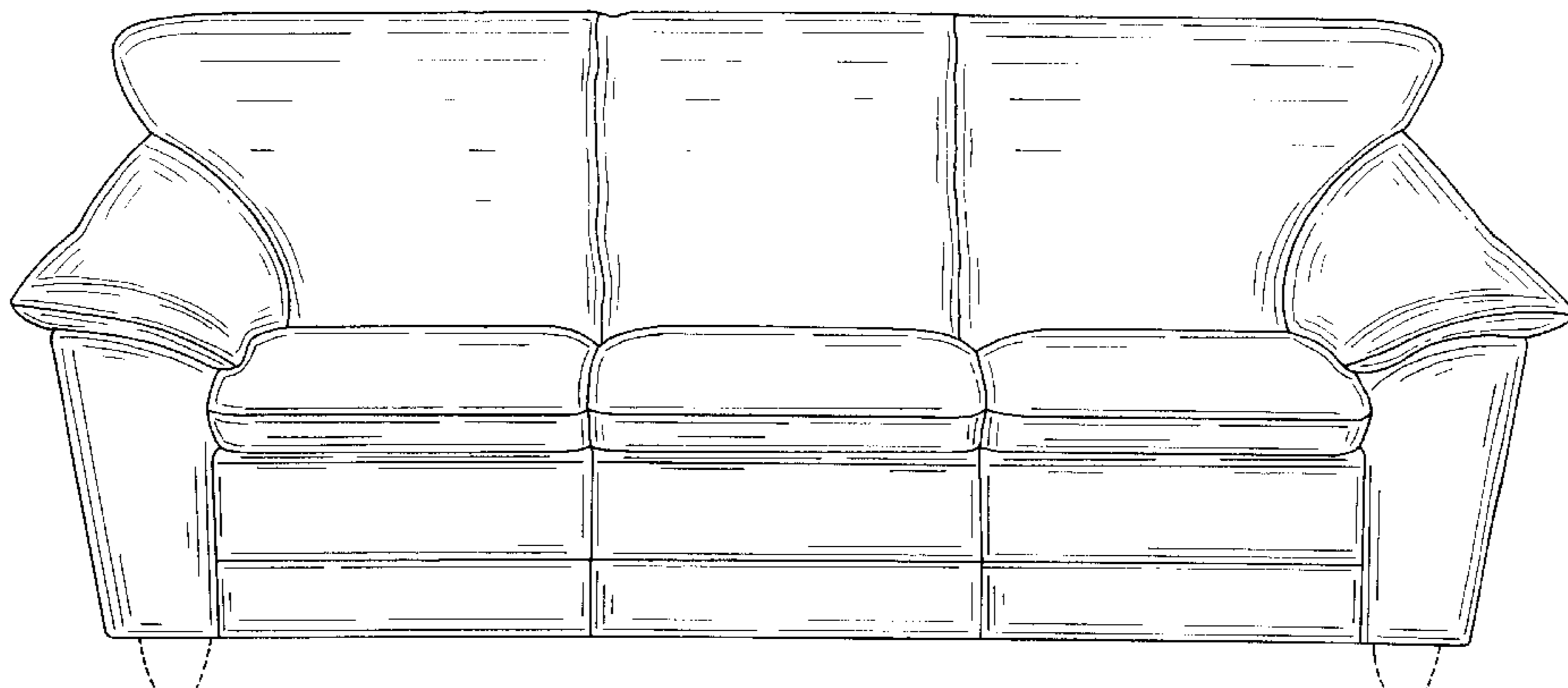

OTHER PUBLICATIONS

Natuzzi Model 956, Sep. 1992, at International Home Furnishings Market in High Point, North Carolina.
Natuzzi Model 1020, Mar. 1993, at International Home Furnishings Market in High Point, North Carolina.
Natuzzi Model 1022, Mar. 1993, at International Home Furnishings Market in High Point, North Carolina.
Natuzzi Model 1027, Mar. 1993, at International Home Furnishings Market in High Point, North Carolina.
Natuzzi Model 1087, Sep. 1993, at International Home Furnishings Market in High Point, North Carolina.
Natuzzi Model 1090, Sep. 1993, at International Home Furnishings Market in High Point, North Carolina.
Natuzzi Model 1094, Sep. 1993, at International Home Furnishings Market in High Point, North Carolina.
Natuzzi Model 1100, Oct. 1993, at International Home Furnishings Market in High Point, North Carolina.
Natuzzi Model 1109, Oct. 1993, at International Home Furnishings Market in High Point, North Carolina.
Natuzzi Model 1118, Oct. 1993, at International Home Furnishings Market in High Point, North Carolina.
Natuzzi Model 1123, Jan. 1994, at International Home Furnishings Market in High Point, North Carolina.
Natuzzi Model 1127, Jan. 1994, at International Home Furnishings Market in High Point, North Carolina.

Natuzzi Model 1127, Jan. 1994, at International Home Furnishings Market in High Point, North Carolina.
Natuzzi Model 1345, Sep. 1995, at International Home Furnishings Market in High Point, North Carolina.
Natuzzi Model 1352, Sep. 1995, at International Home Furnishings Market in High Point, North Carolina.
Natuzzi Model 1366, Sep. 1995, at International Home Furnishings Market in High Point, North Carolina.
Natuzzi Model 1371, Oct. 1995, at International Home Furnishings Market in High Point, North Carolina.
Natuzzi Model 1378, Oct. 1995, at International Home Furnishings Market in High Point, North Carolina.
Natuzzi Model 1411, Mar. 1996, at International Home Furnishings Market in High Point, North Carolina.
Natuzzi Model 1439, Mar. 1996, at International Home Furnishings Market in High Point, North Carolina.
Natuzzi Model 1448, Mar. 1996, at International Home Furnishings Market in High Point, North Carolina.
Natuzzi Model 1455, Apr. 1996, at International Home Furnishings Market in High Point, North Carolina.
Natuzzi Model 1462, Apr. 1996, at International Home Furnishings Market in High Point, North Carolina.

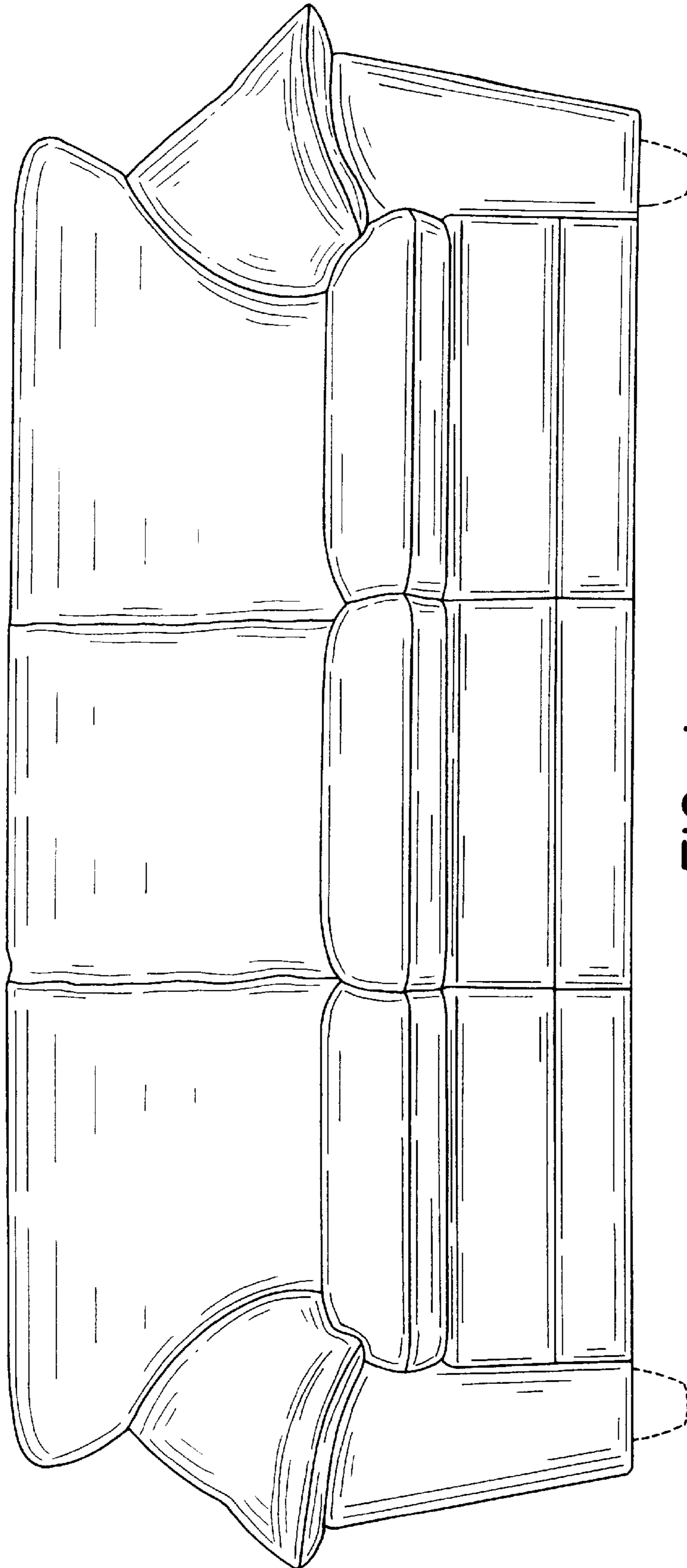

FIG. 1.



FIG. 2.

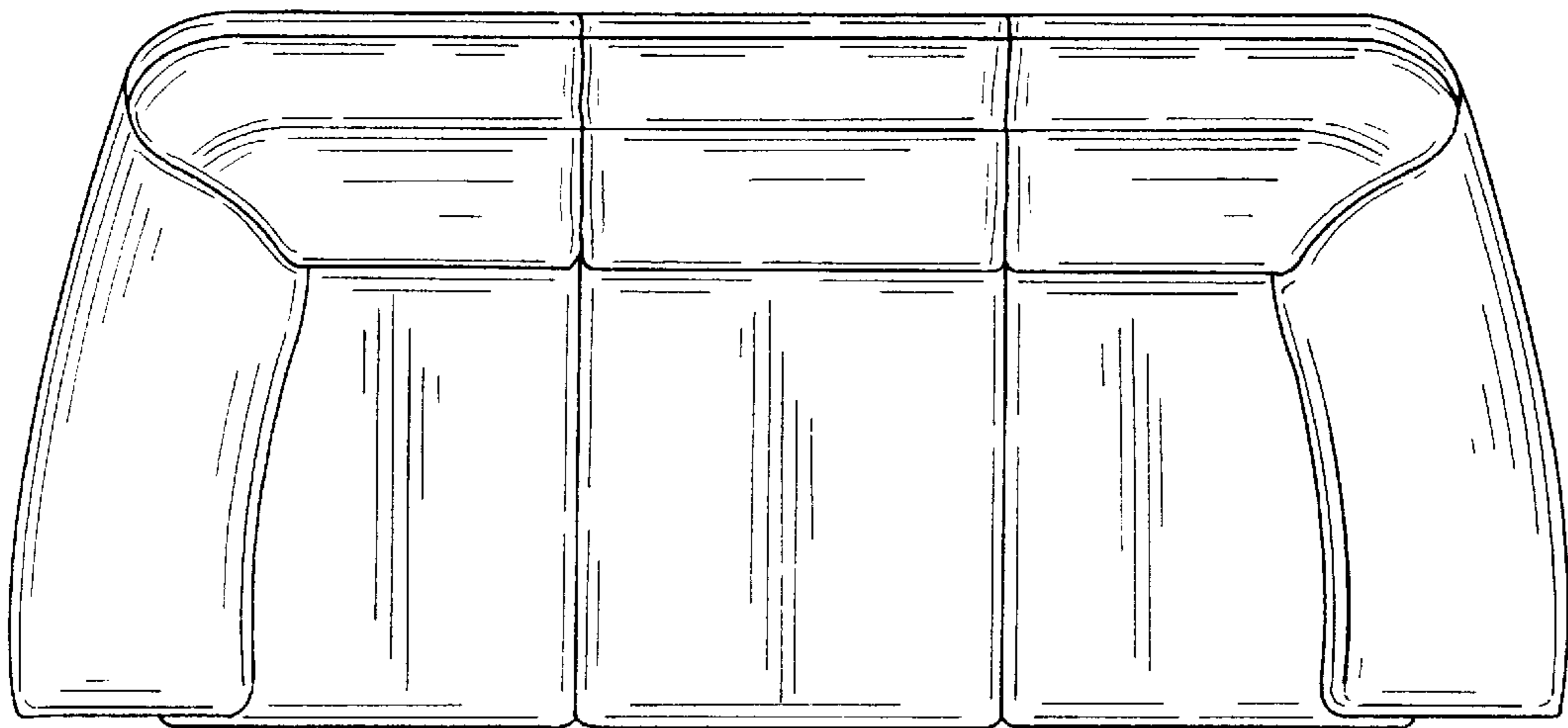

FIG. 3.

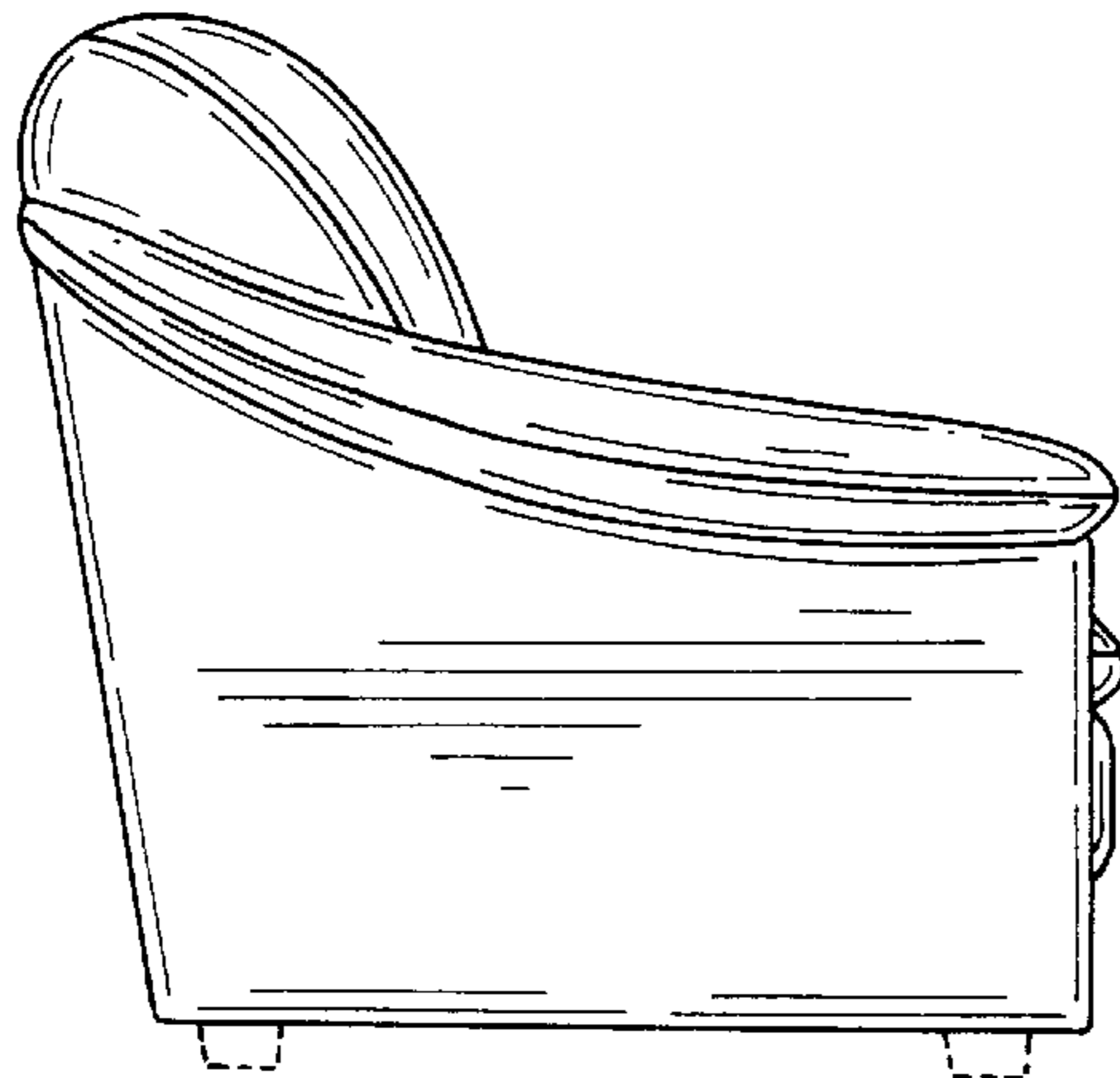

FIG. 4.

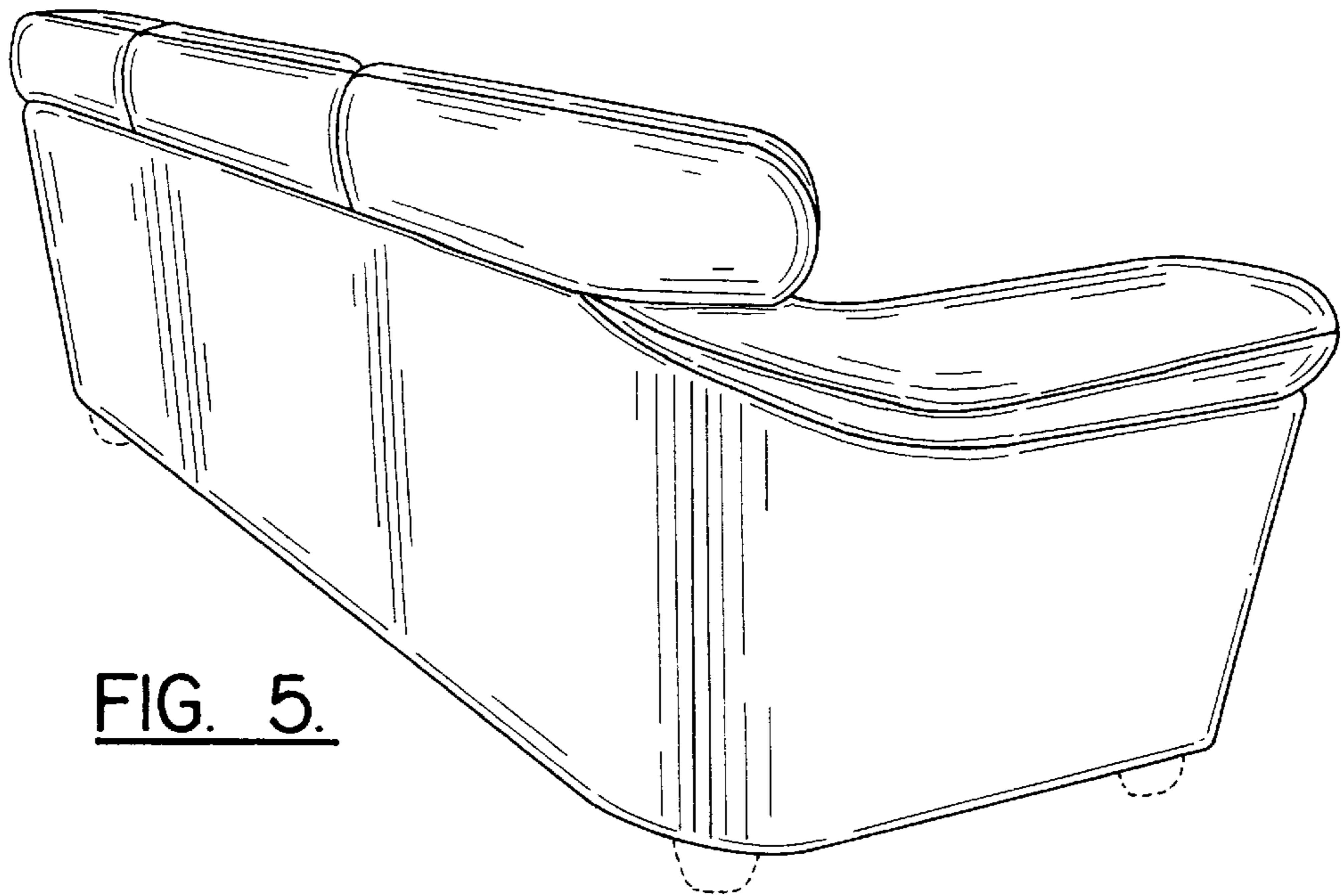

FIG. 5.

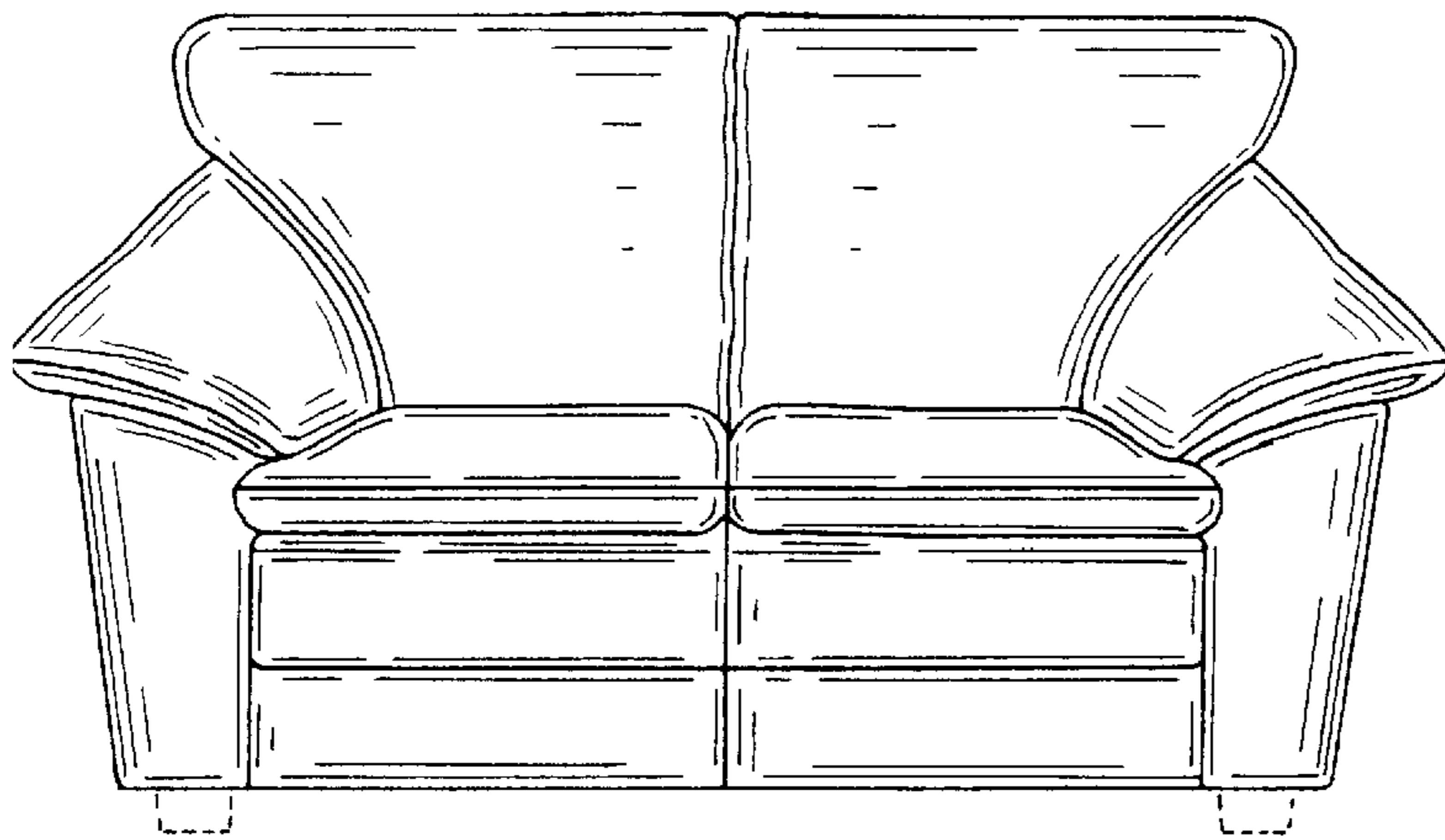

FIG. 6.

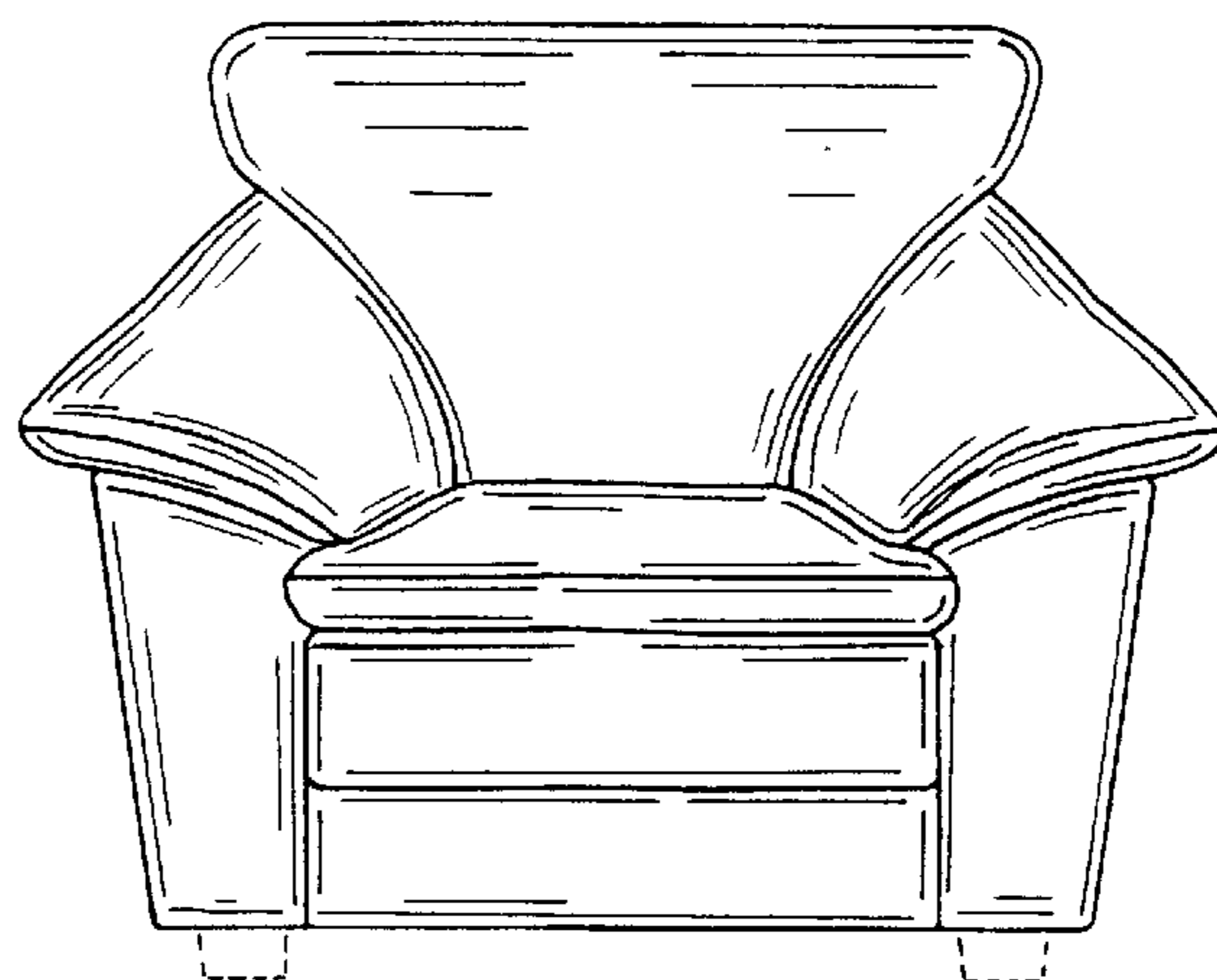

FIG. 7.

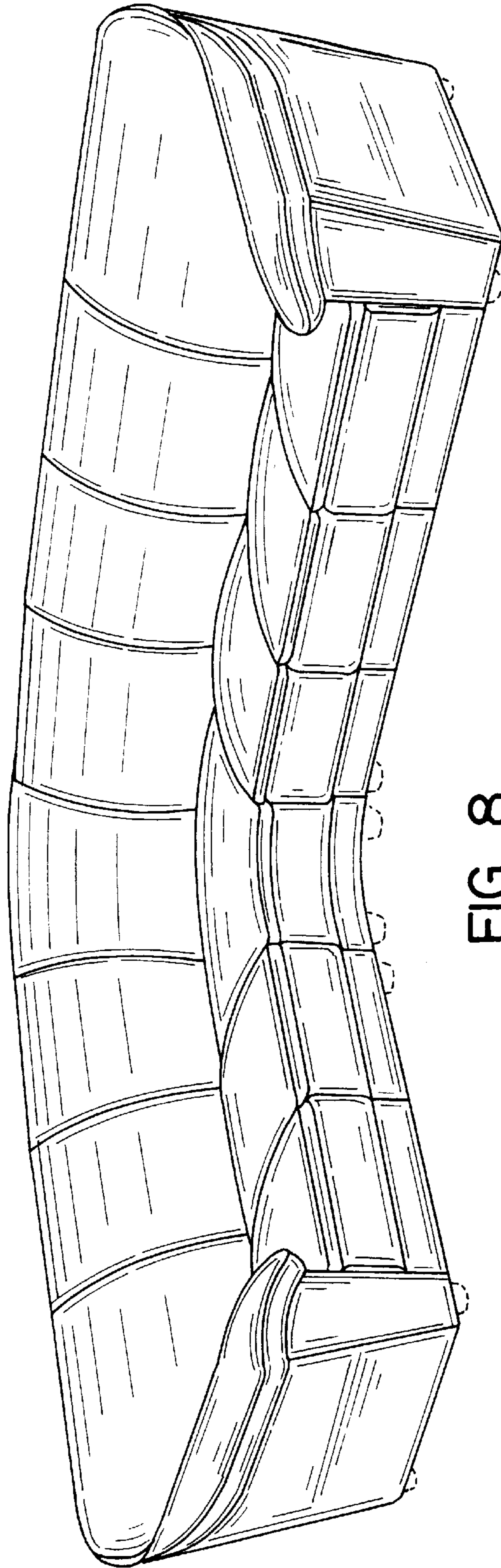

FIG. 8.

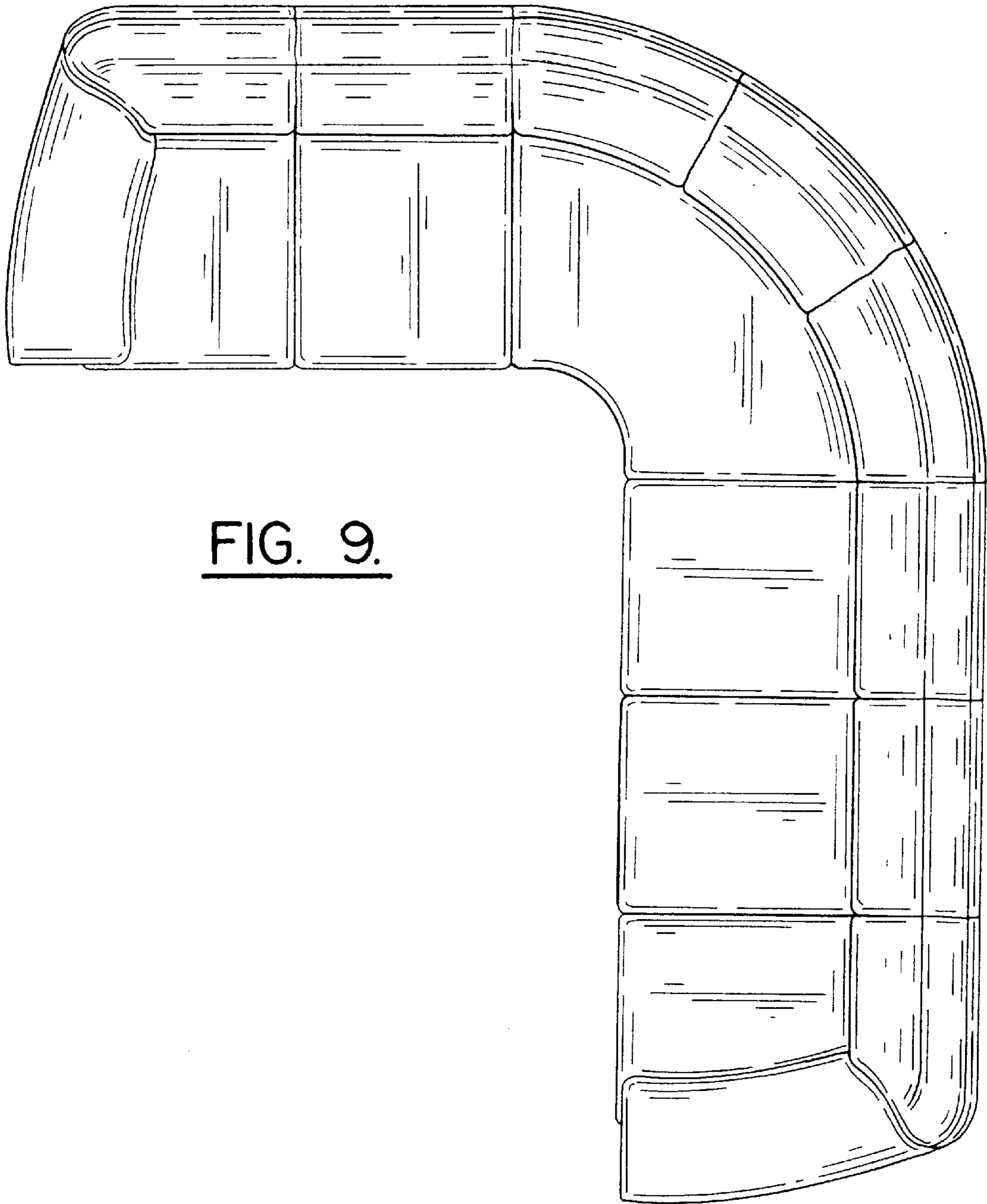

FIG. 9.

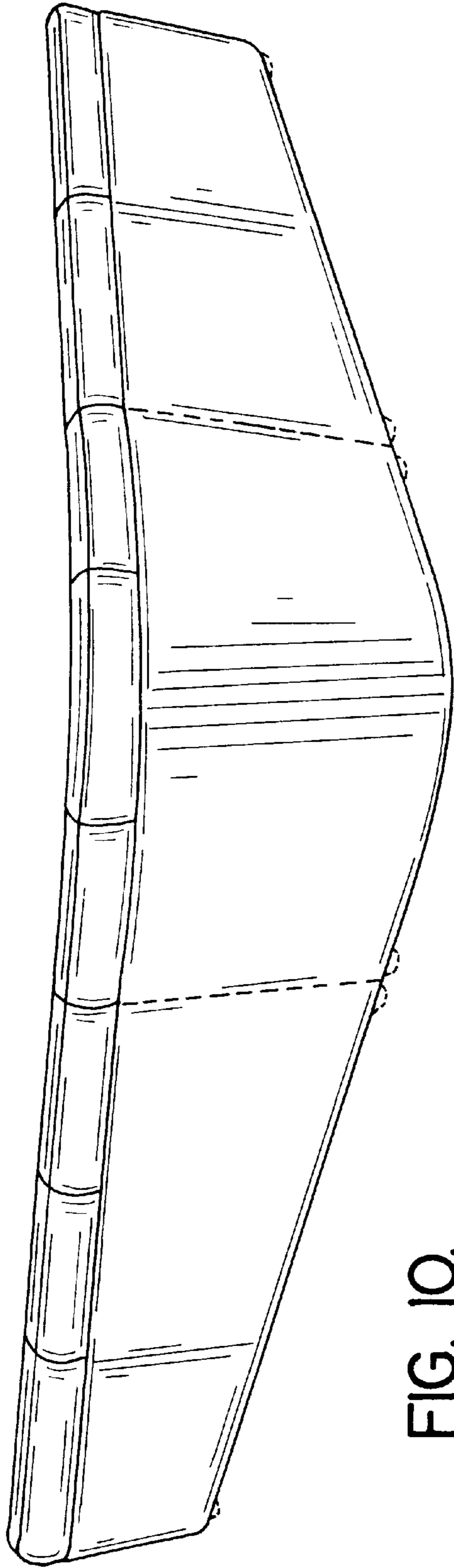

FIG. 10.