



US00D417961S

United States Patent [19]
Powis, Jr.

[11] **Patent Number: Des. 417,961**

[45] **Date of Patent: ** Dec. 28, 1999**

[54] **CLEANING BRUSH CAPABLE OF BEING REMOVABLY ATTACHED TO A TOWEL**

[76] Inventor: **George S. Powis, Jr.**, 182 Lincoln Ave., Telford, Pa. 18969

[**] Term: **14 Years**

[21] Appl. No.: **29/097,899**

[22] Filed: **Dec. 17, 1998**

[51] **LOC (6) Cl.** **04-01**

[52] **U.S. Cl.** **D4/127**

[58] **Field of Search** D4/127, 130, 135, D4/116; 15/159.1, 160, 186, 187, 114

[56] **References Cited**

U.S. PATENT DOCUMENTS

D. 51,319	10/1917	Montgomery	D4/127
D. 339,473	9/1993	Lewis et al.	D4/116
5,075,918	12/1991	Zeltner et al.	15/114 X
5,555,589	9/1996	Moultrie	15/160 X

OTHER PUBLICATIONS

Denali Products, Inc., "Clean & Shine", 1 page printout from internet web cite of Denali Products, Inc., Aug. 1997.
Denali Products, Inc., "Complete Price List, Aug. 1997", 2 page printout from internet web cite of Denali Products, Inc.
Denali Products, Inc., "Gear Caddy, Clubtub, and All Our Other Accessories Make Great Gifts!", 1 page advertisement, Aug. 1997.

Primary Examiner—Alan P. Douglas
Assistant Examiner—Lavone D. Tabor
Attorney, Agent, or Firm—Howson and Howson

[57] **CLAIM**

The ornamental design for a cleaning brush capable of being removably attached to a towel, as shown and described.

DESCRIPTION

FIG. 1 is a perspective view of a cleaning brush embodying my new design;

FIG. 2 is a top plan view of the cleaning brush of FIG. 1; FIG. 3 is a front elevational view of the cleaning brush of FIG. 1, the rear, right side and left side elevational views being a mirror image thereof;

FIG. 4 is a bottom plan view of the cleaning brush of FIG. 1;

FIG. 5 is a perspective view of the cleaning brush of FIG. 1 attached to a golf towel which is used to clean golf clubs, golf shoes and golf spikes; and,

FIG. 6 is an exploded perspective view of the cleaning brush and golf towel of FIG. 5 and an O-ring which is used to attach the brush to the towel in a removable manner.

The showing in FIGS. 5 and 6 of a towel and an O-ring is for illustrative purposes only and forms no part of the claimed invention.

1 Claim, 2 Drawing Sheets

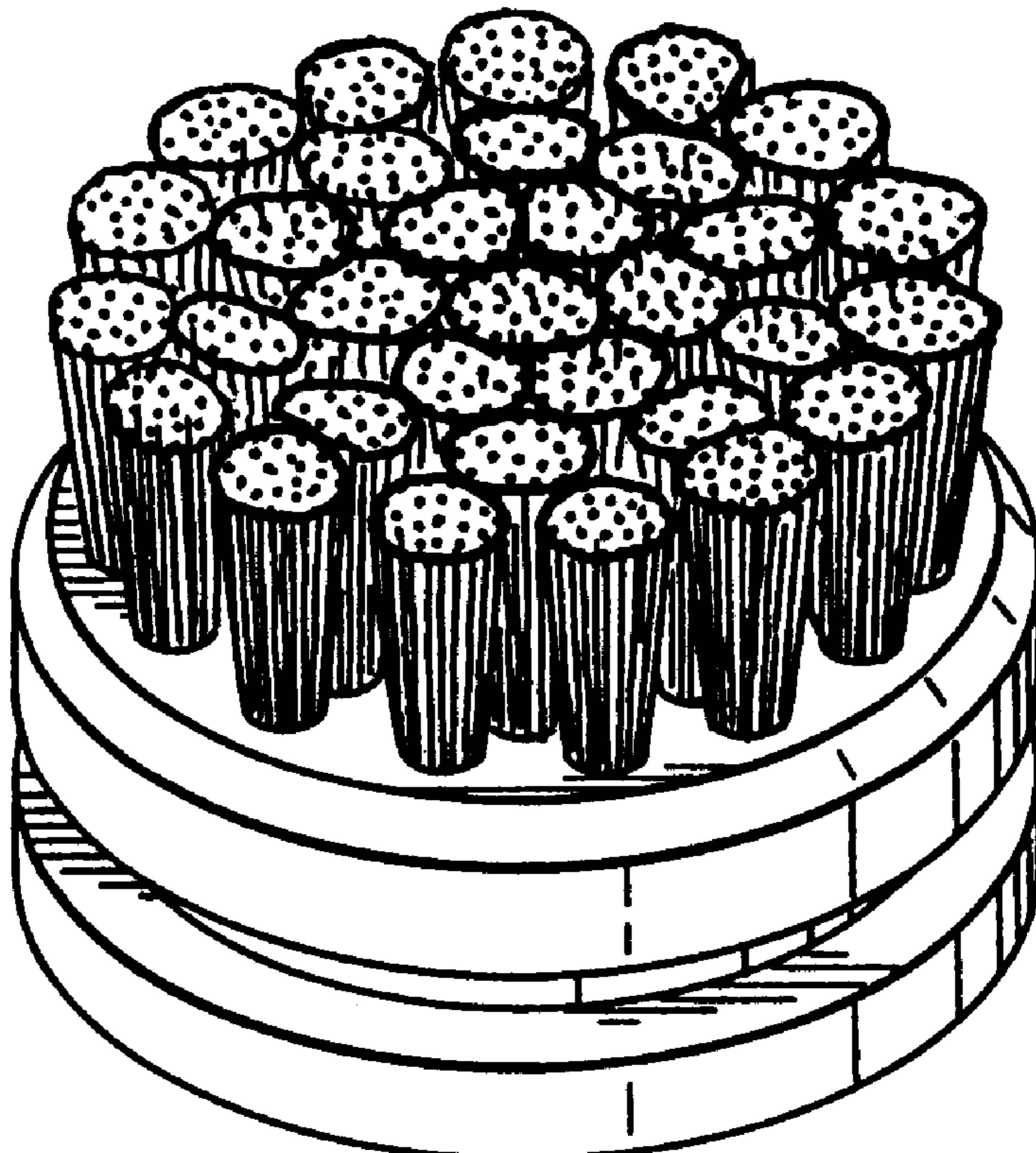

FIG. 1

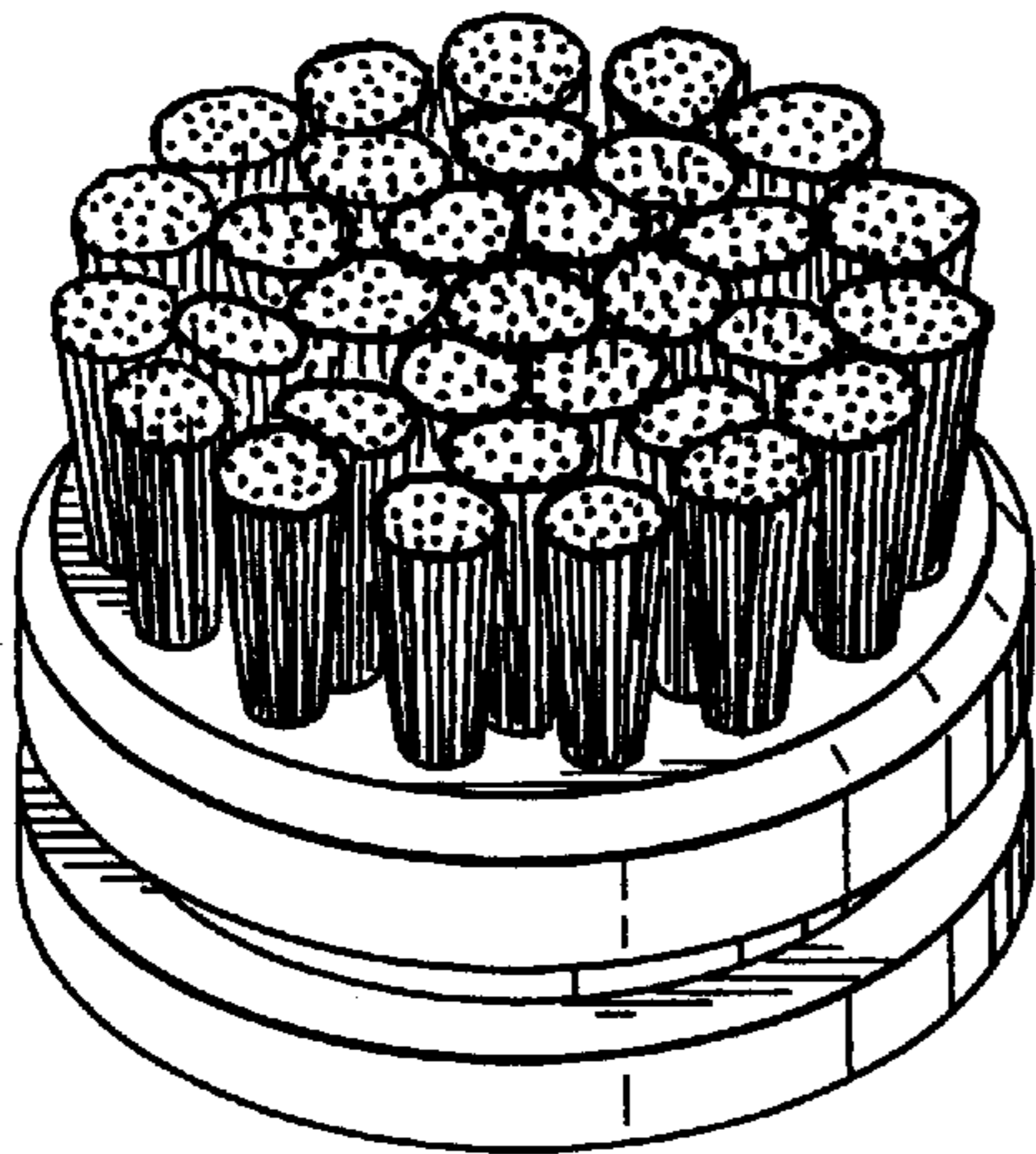

FIG. 2

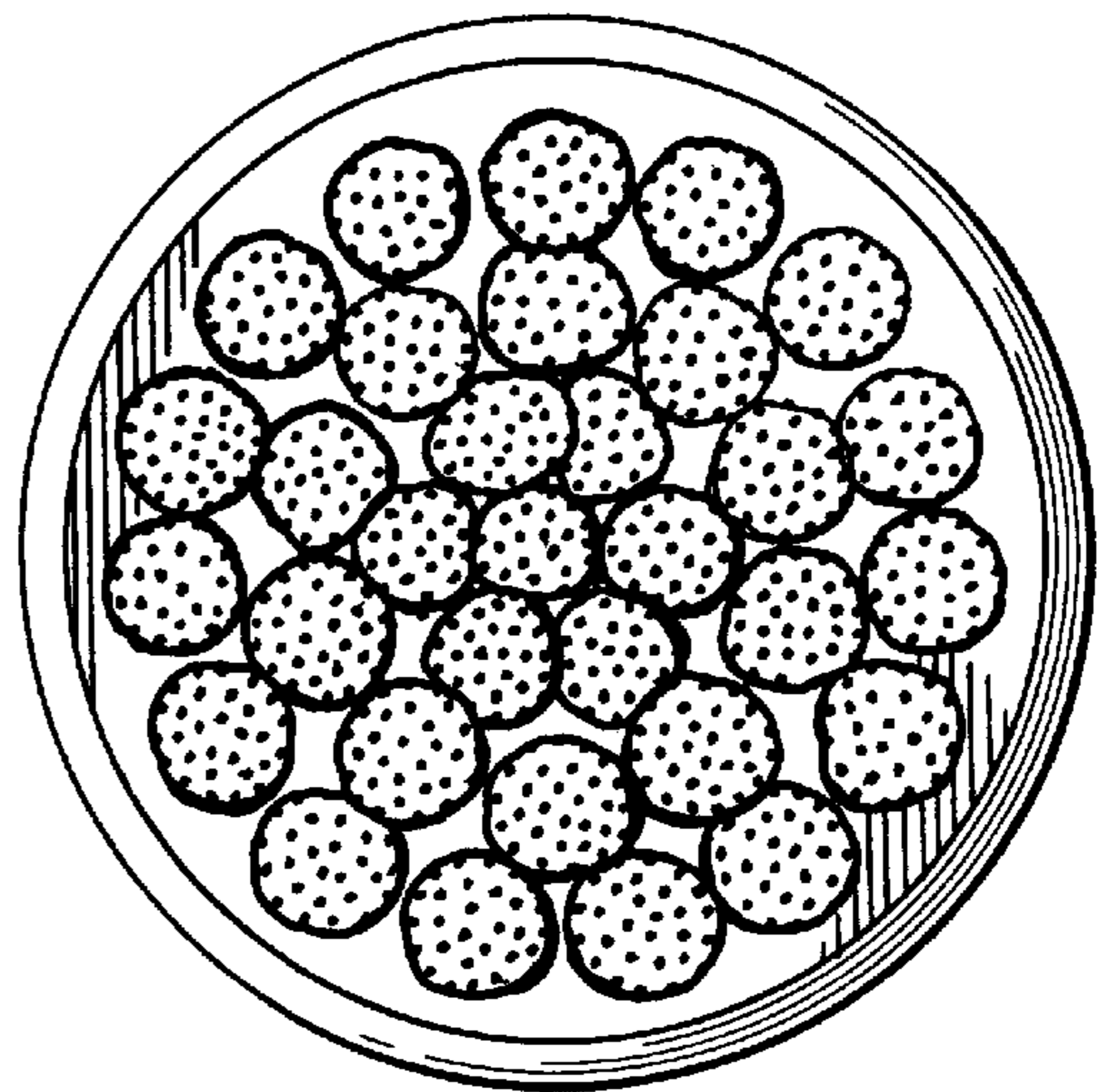

FIG. 3

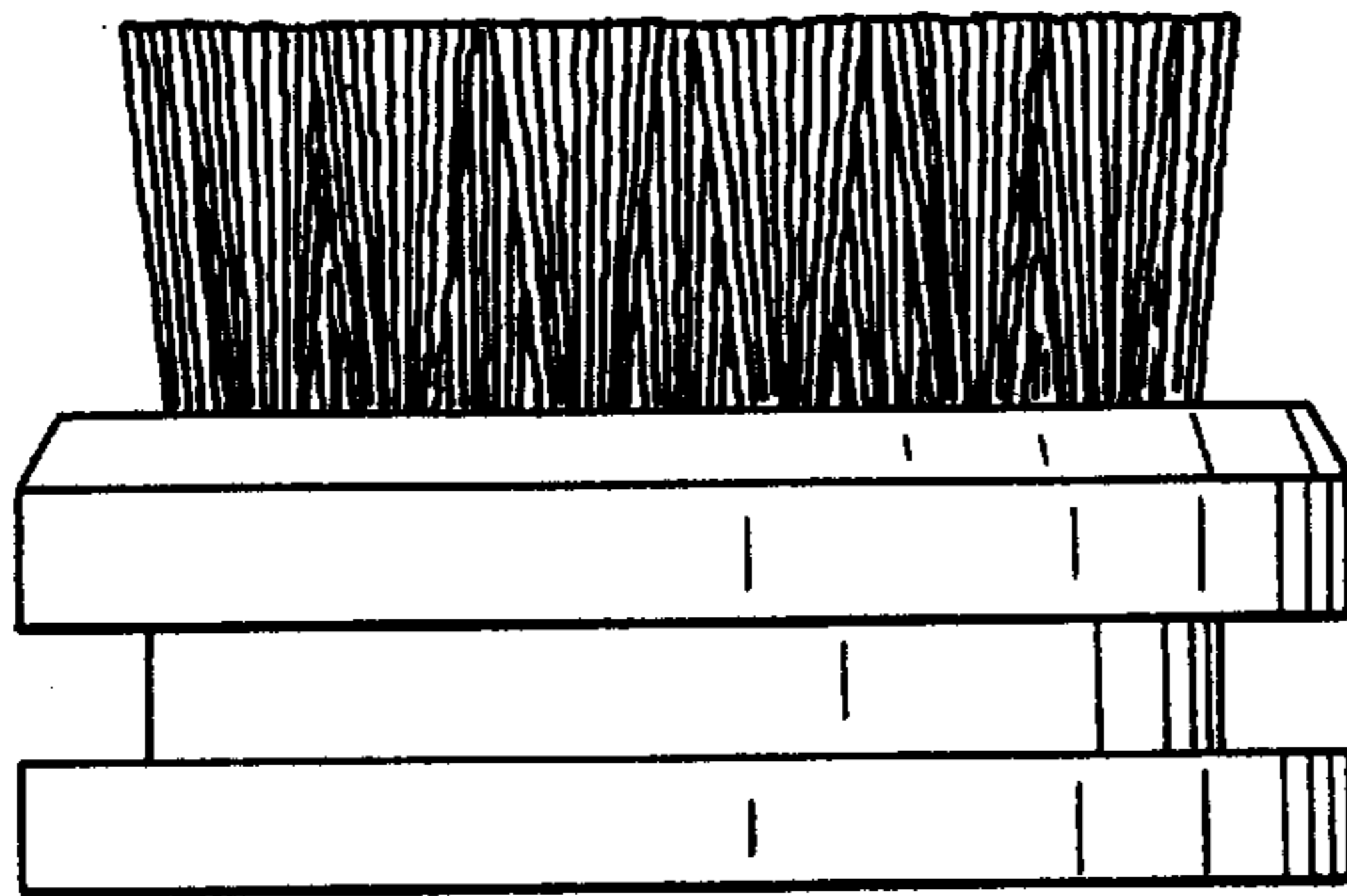
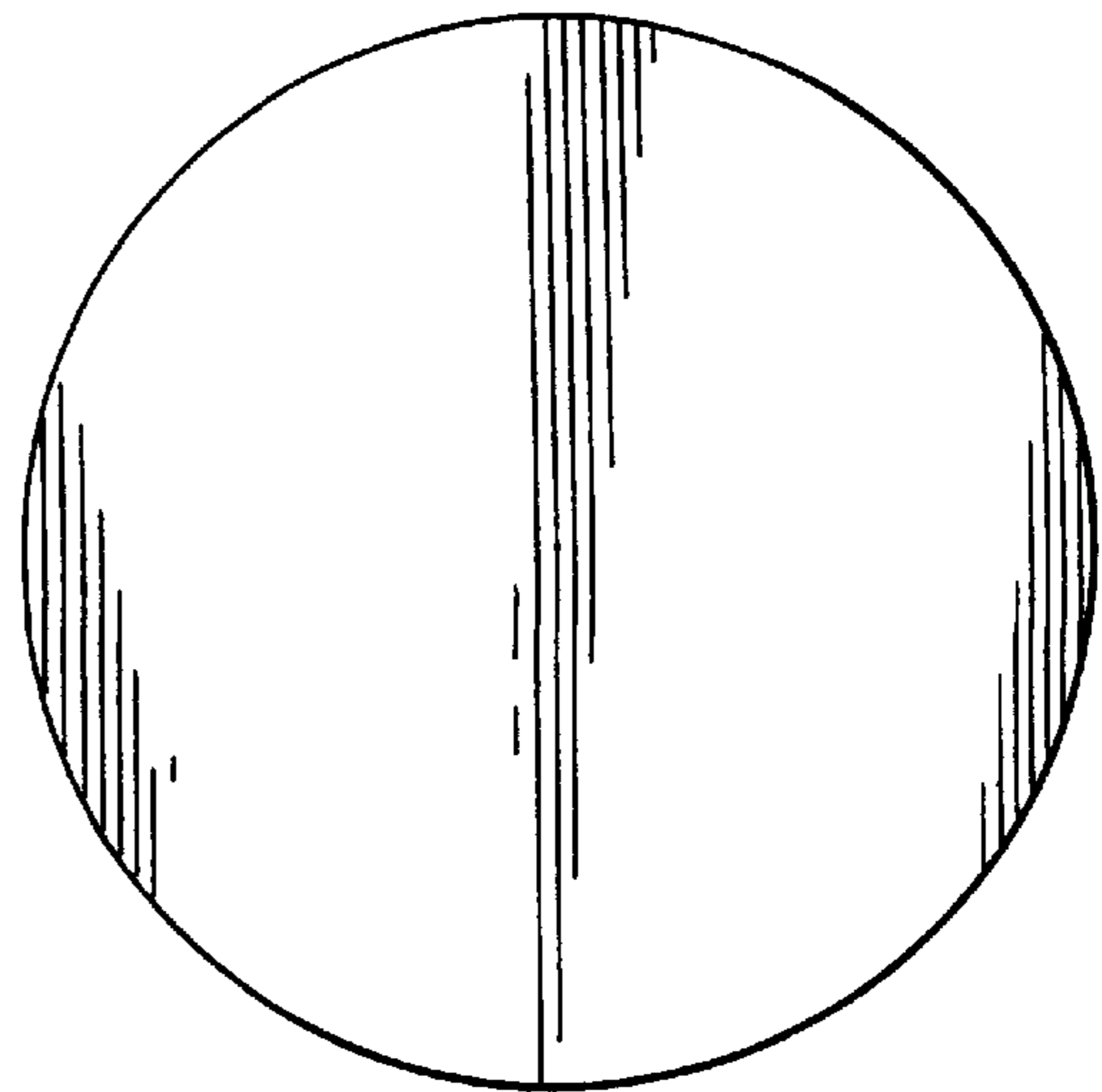

FIG. 4



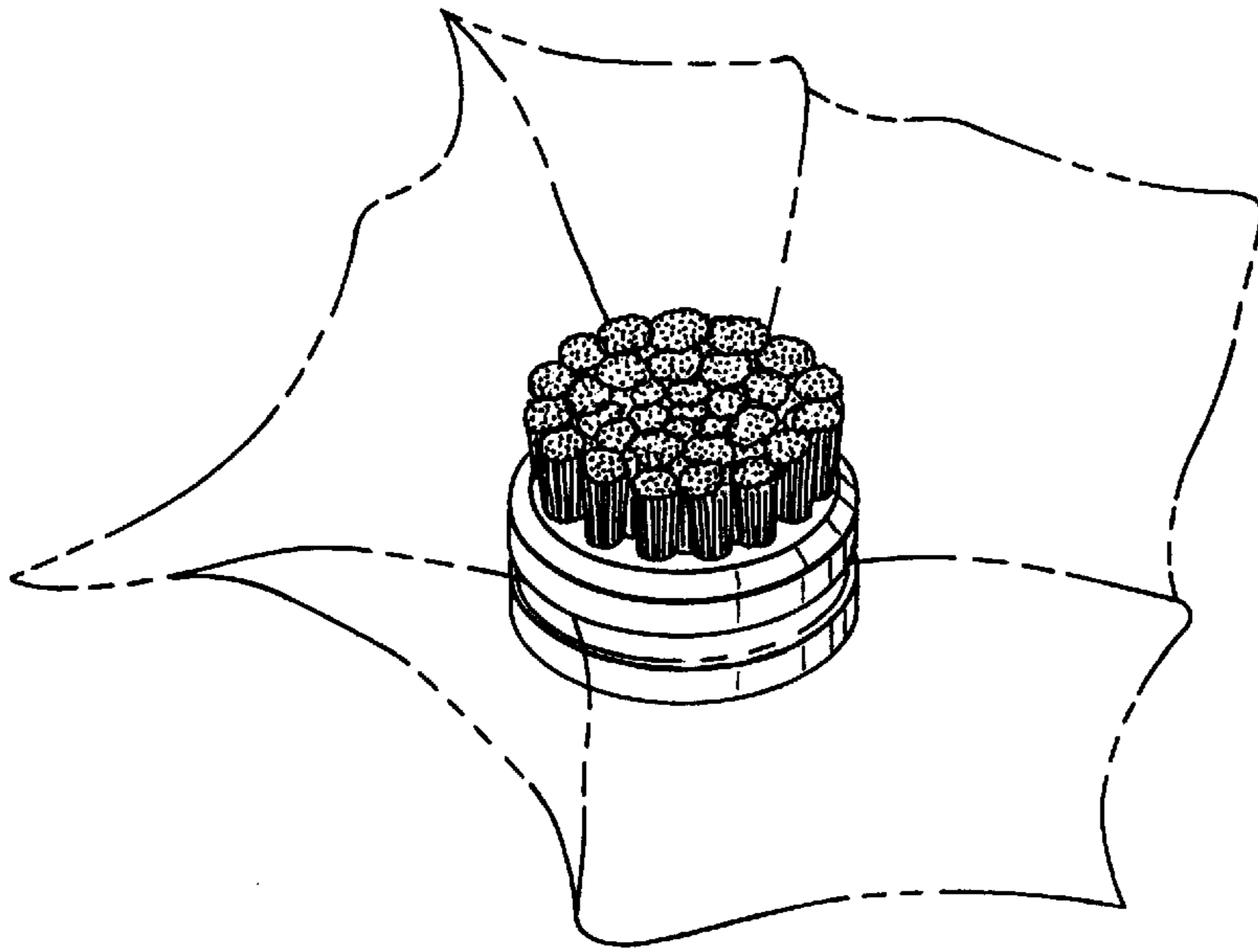

FIG. 5

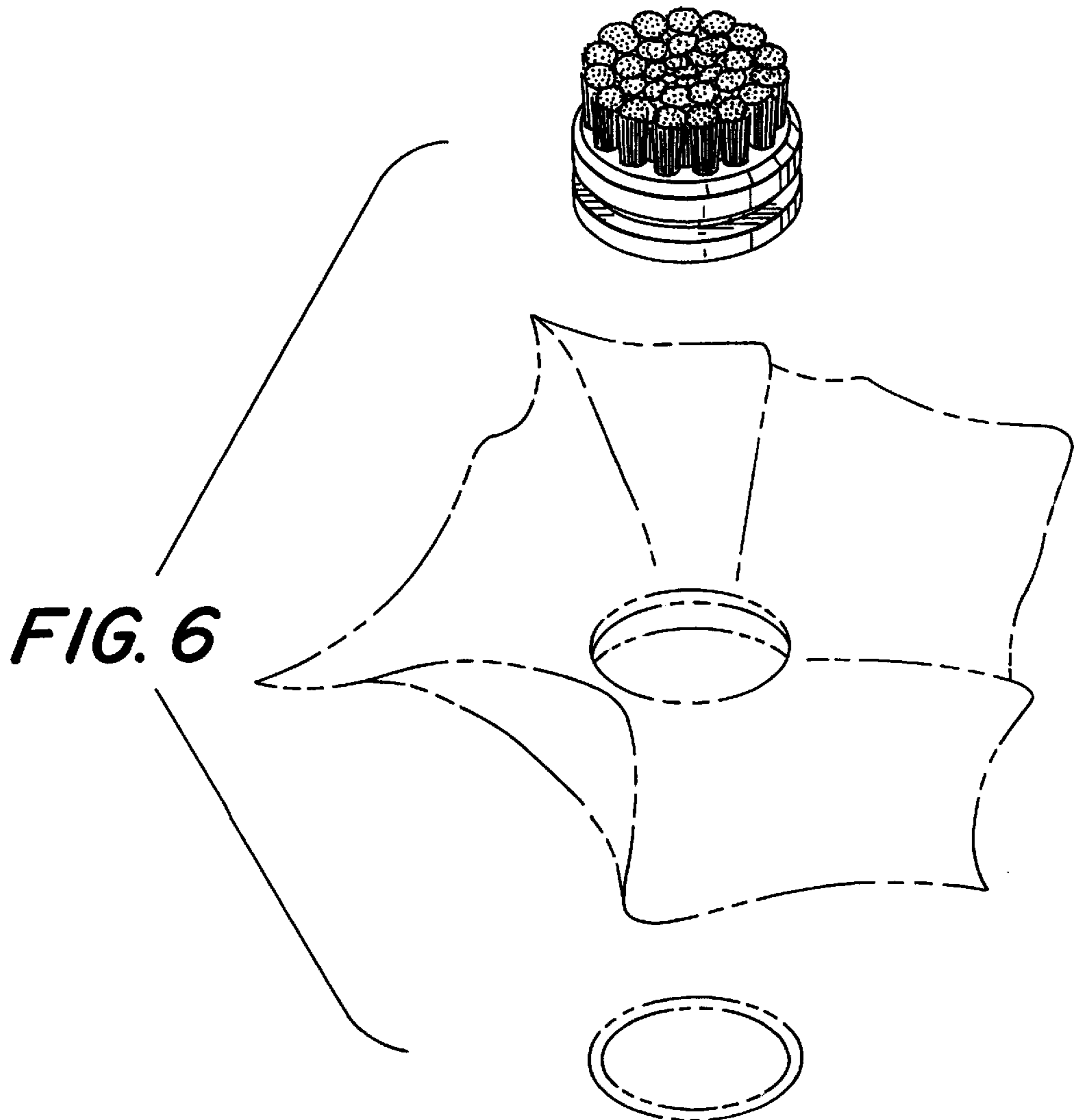

FIG. 6