



US00D417947S

United States Patent [19]

[11] **Patent Number: Des. 417,947**

Lavertue et al.

[45] **Date of Patent: ** Dec. 28, 1999**

[54] **SANDAL UPPER**

[75] Inventors: **Jacques Lavertue**, Rockford, Mich.;
Bruce Rogers, Portland, Oreg.; **Clark A. Matis**, Charlotte, Vt.

[73] Assignee: **Wolverine World Wide, Inc.**,
Rockford, Mich.

[**] Term: **14 Years**

[21] Appl. No.: **29/088,611**

[22] Filed: **May 28, 1998**

[51] **LOC (6) Cl. 02-04**

[52] **U.S. Cl. D2/969; D2/916**

[58] **Field of Search D2/916-919, 969;**
36/50.1, 11.5

Fila Sports-Sandals Pricing Page (acknowledged as prior art).
Teva 1997 Catalog.
ACG Fall 1998 Catalog-selected pages (acknowledged as prior art).
Technica Outdoors Collection 1999 Catalog-selected pages (acknowledged as prior art).
ACG Spring 1999 Catalog-selected pages (acknowledged as prior art).
Merrell 1997 Catalog-selected pages.
Merrell Spring & Summer 1996 Catalog-selected pages.

Primary Examiner—Louis S. Zarfes
Assistant Examiner—G Andoll
Attorney, Agent, or Firm—Warner Norcross & Judd LLP

[57] CLAIM

The ornamental design for sandal upper, as shown and described.

[56] References Cited

U.S. PATENT DOCUMENTS

D. 347,309	5/1994	McDonald	D2/969
D. 353,038	12/1994	Morris et al.	D2/969
D. 360,973	8/1995	Bailey	D2/969
D. 362,745	10/1995	Skrivanek	D2/916
D. 364,497	11/1995	Schelling	D2/916
D. 367,163	2/1996	Johnson	D2/916
D. 368,798	4/1996	Tong	D2/969
D. 379,866	6/1997	Jenkins	D2/969
D. 385,094	10/1997	Hardigan	D2/969
2,894,338	7/1959	Scholl	36/11.5
5,561,919	10/1996	Gill	36/11.5
5,687,492	11/1997	Muraoka	36/11.5

OTHER PUBLICATIONS

Nkie Spring Footwear Catalog; p. 97, Air Deschutz Pro; p. 97, Alsek; p. 98 Air Tiyo; p. 182 Tiyo (BG & BP), Mar. 1997.

DESCRIPTION

FIG. 1 is a perspective view of the sandal upper embodying the new design;
FIG. 2 is a front elevational view thereof;
FIG. 3 is a rear elevational view thereof;
FIG. 4 is a top plan view thereof;
FIG. 5 is a left side elevational view thereof;
FIG. 6 is a right side elevational view thereof. and,
FIG. 7 is a bottom plan view thereof.
The broken lines showing the sole in the figures is for illustrative purposes only and forms no part of the claimed design. The surfaces that are not shown form no part of the claimed design.
The broken lines which define the bounds of the claimed design form no part thereof.

1 Claim, 6 Drawing Sheets

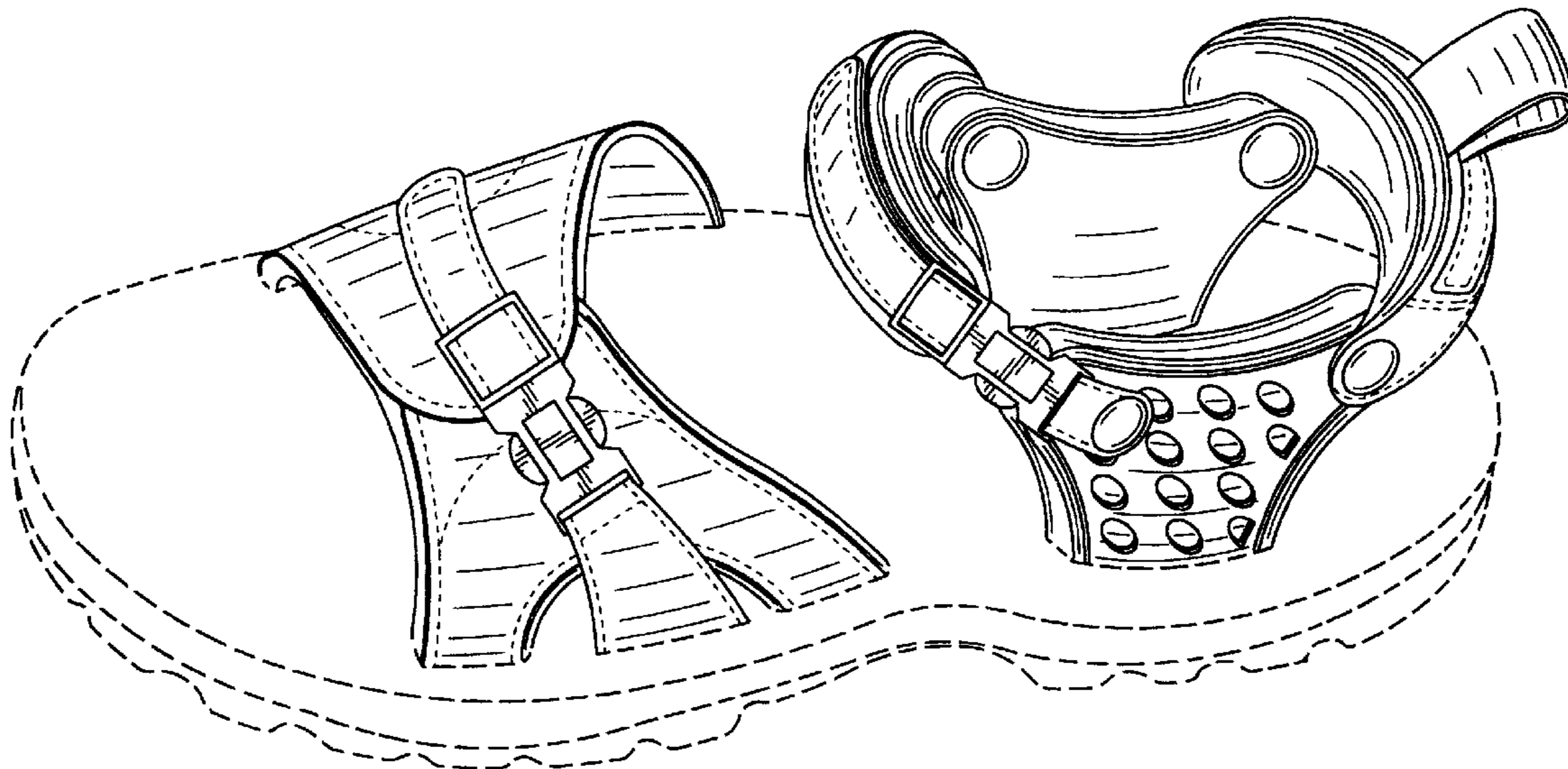

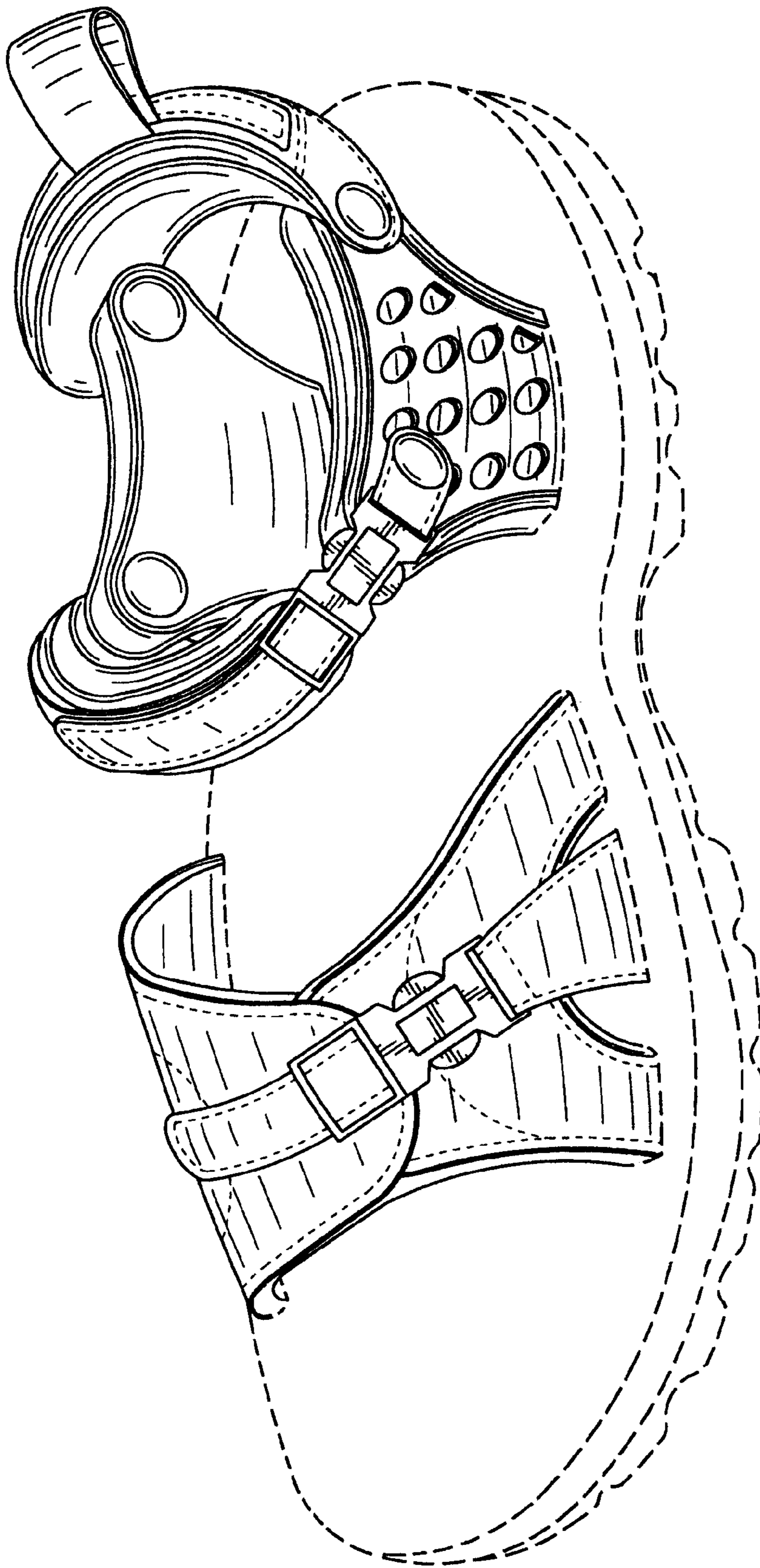

FIG. 1

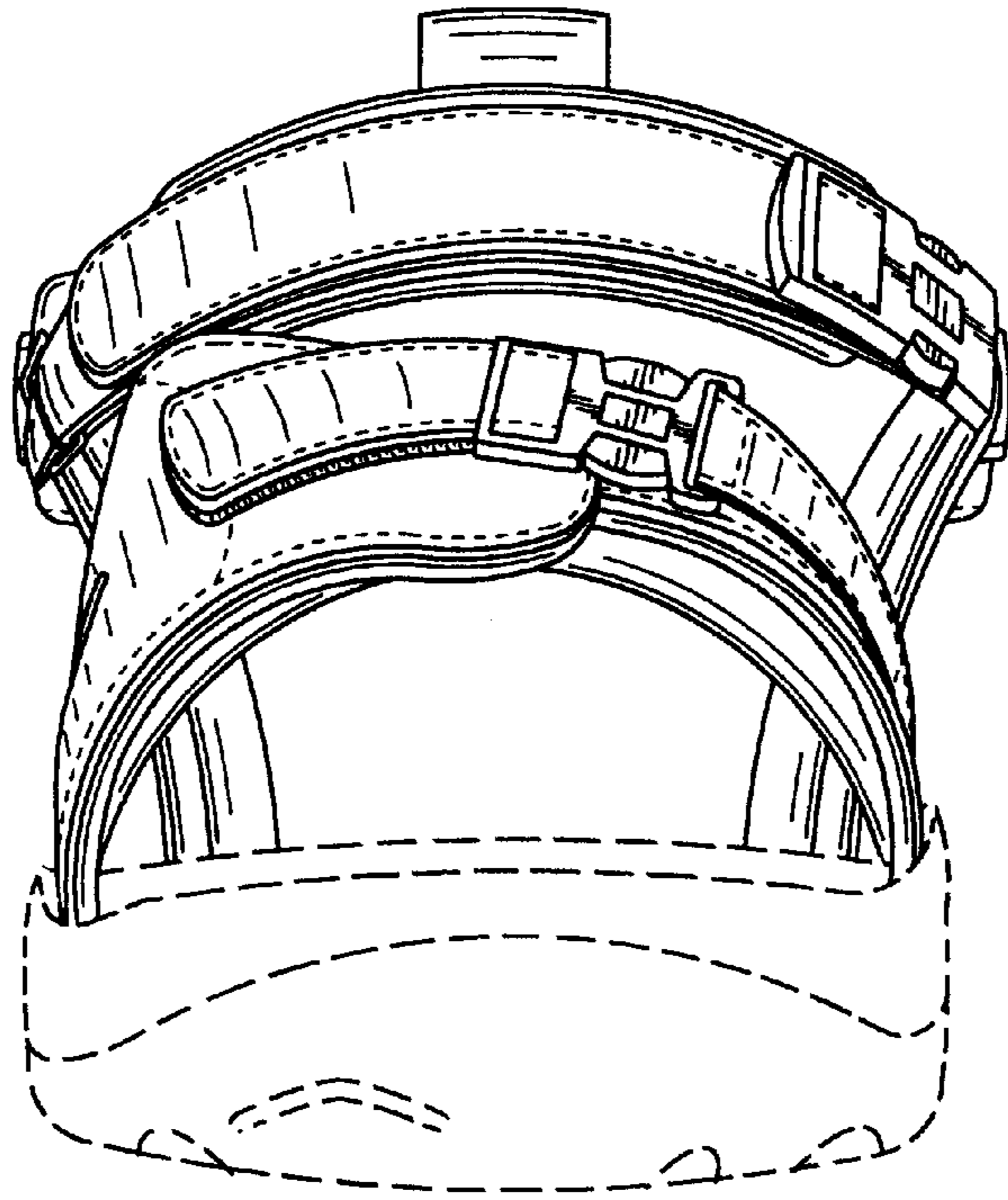

FIG. 2

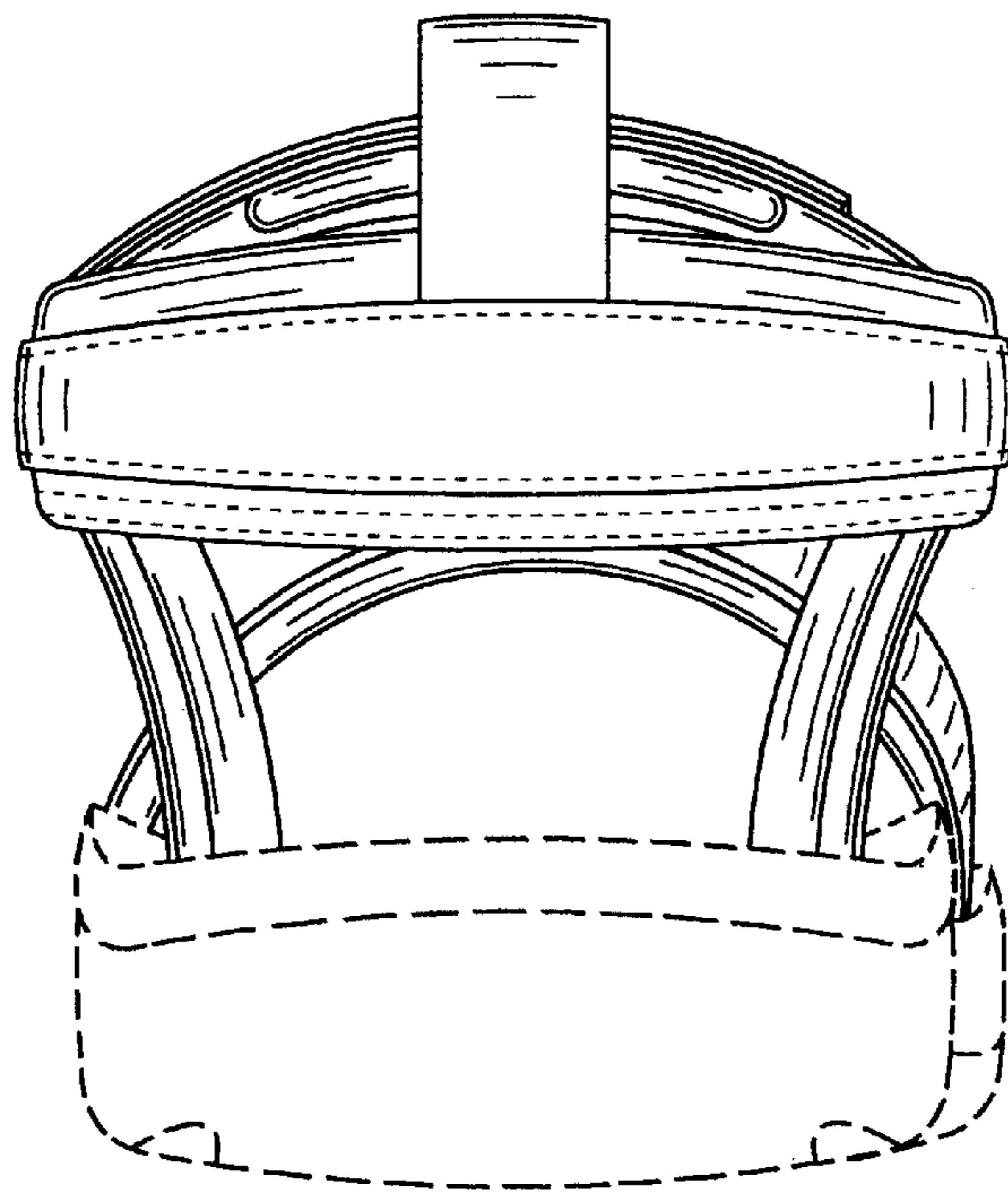

FIG. 3

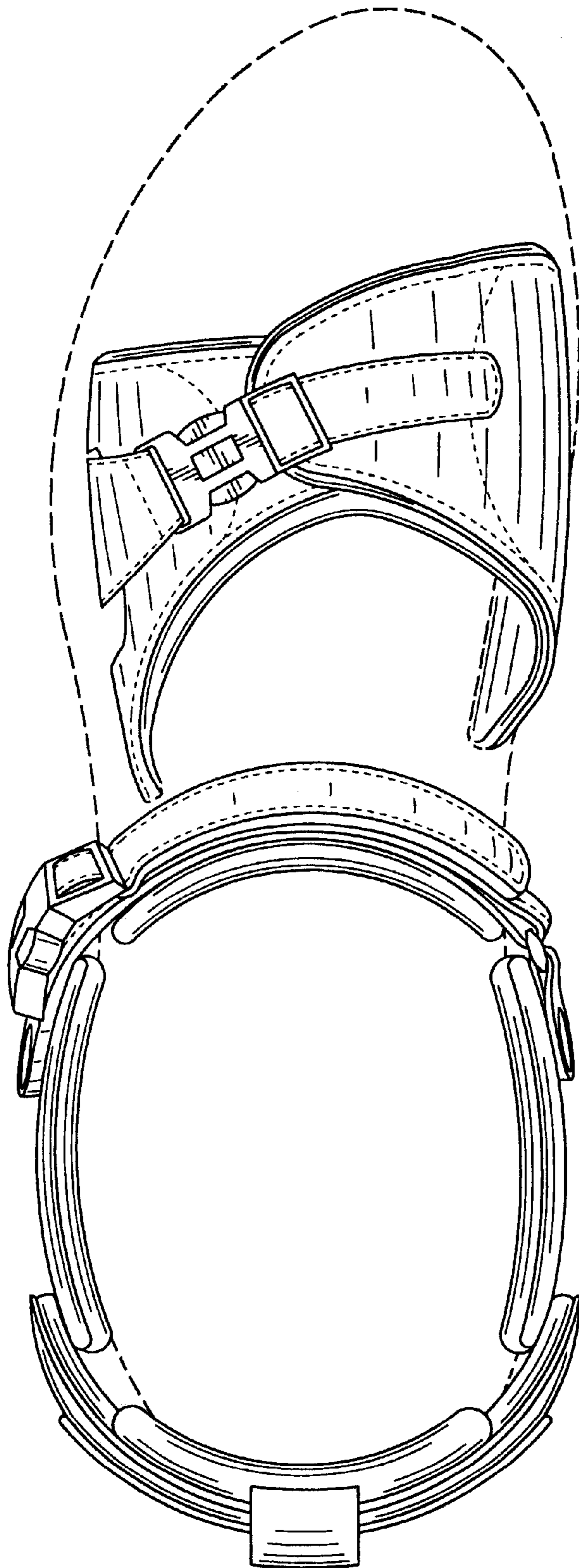

FIG. 4

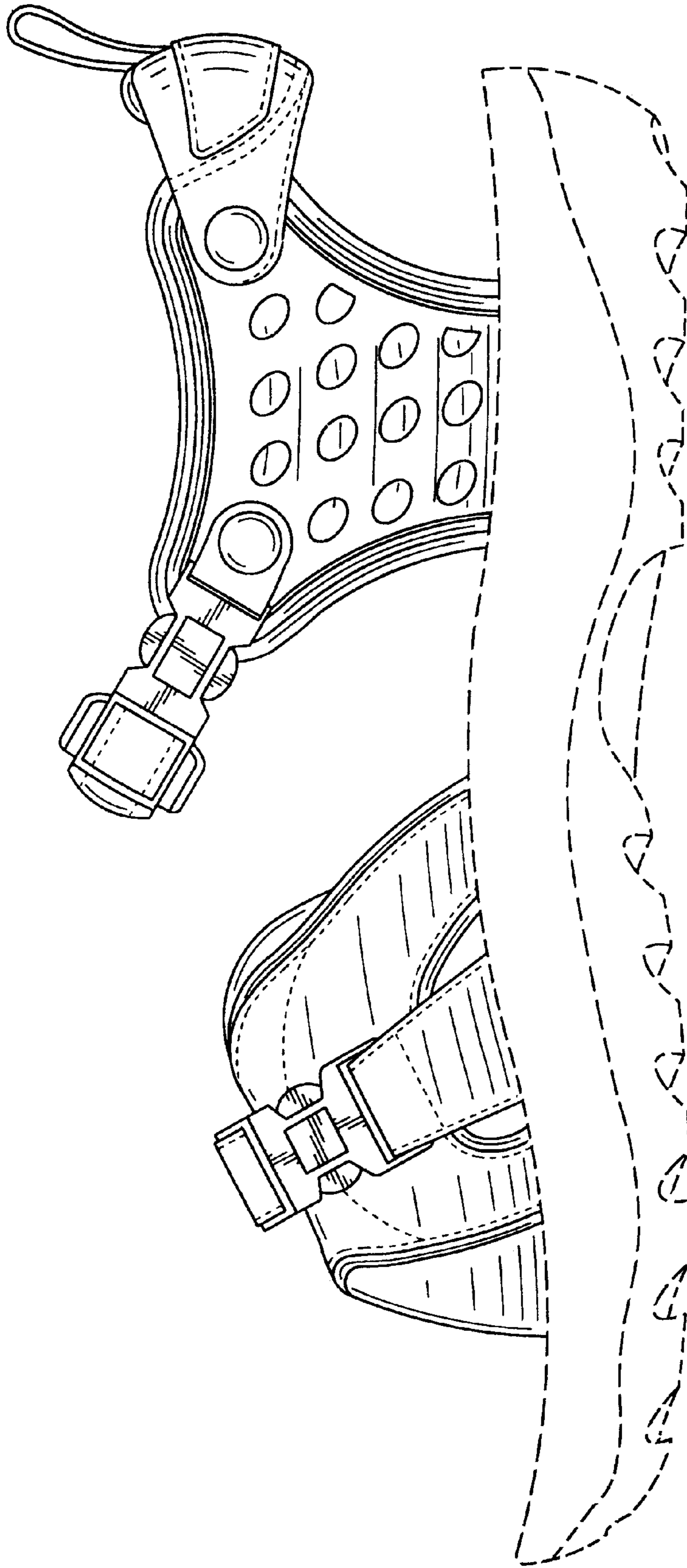

FIG. 5

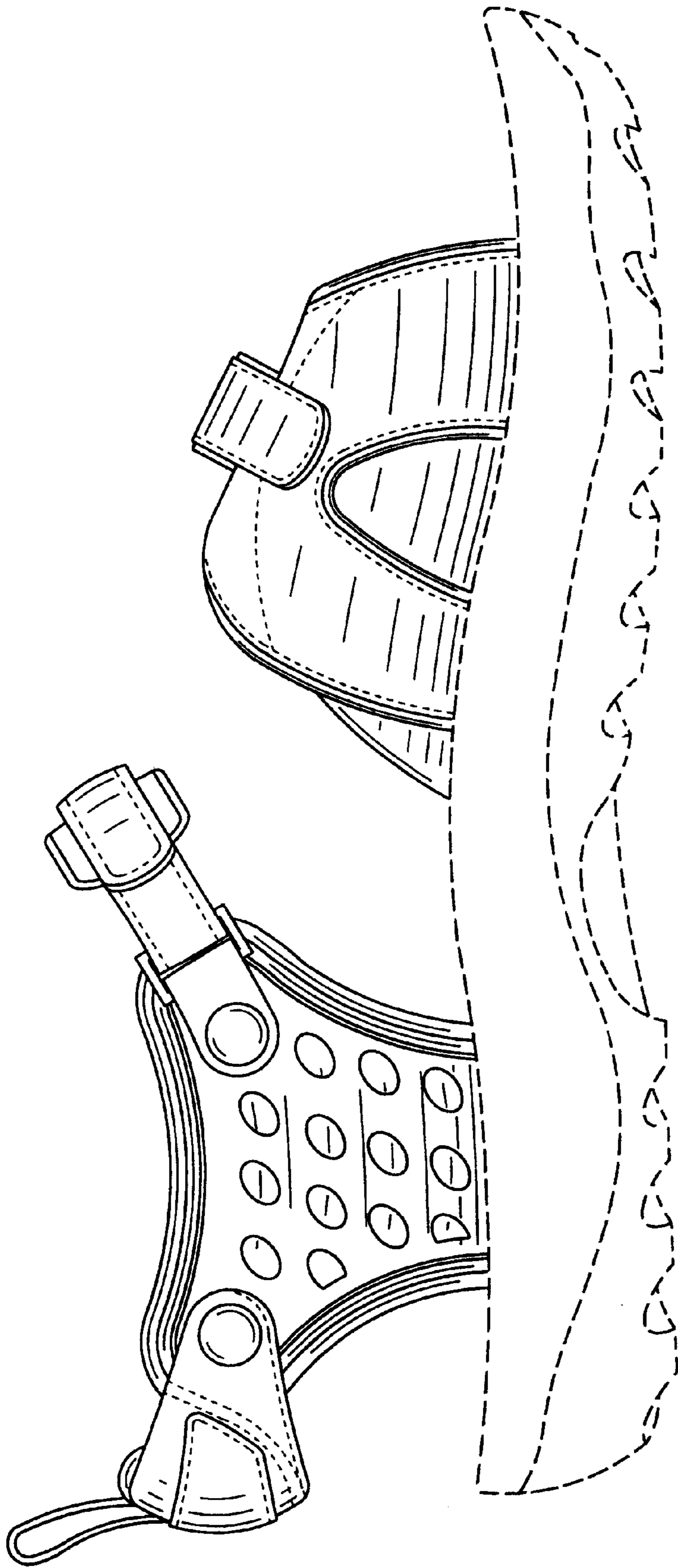

FIG. 6

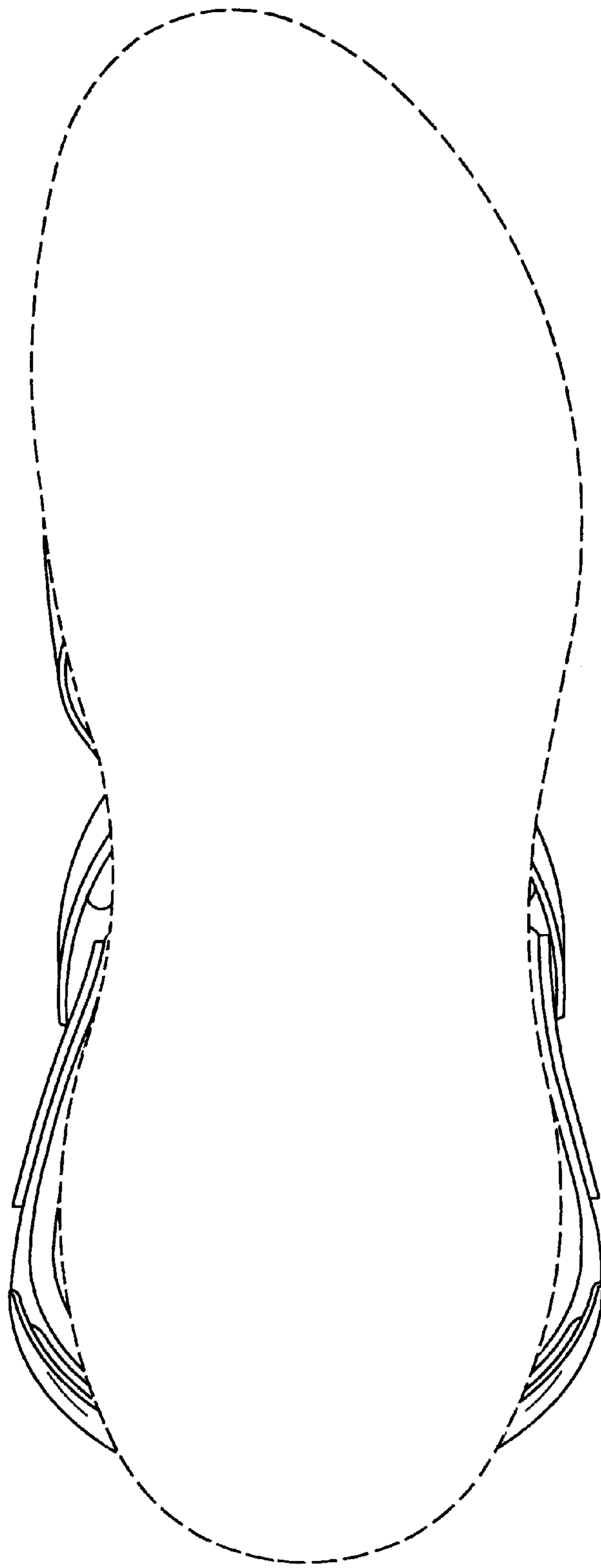

FIG. 7