



US00D417928S

# United States Patent [19] Camacho

[11] Patent Number: Des. 417,928

[45] Date of Patent: \*\* Dec. 21, 1999

[54] LAMP

[76] Inventor: Francisco Camacho, 9328 SW. 38 St., Miami, Fla. 33165

[\*\*] Term: 14 Years

[21] Appl. No.: 29/091,876

[22] Filed: Aug. 7, 1998

[51] LOC (6) Cl. .... 26-05

[52] U.S. Cl. .... D26/106

[58] Field of Search ..... D26/93, 101, 102-112, D26/58, 75-79; 362/410-414, 806, 97, 127, 134, 222, 223; D6/480, 486, 487, 399

[56] **References Cited**

**U.S. PATENT DOCUMENTS**

D. 179,869	3/1957	Vondy et al. ....	D26/105
D. 255,628	7/1980	Van Koert ....	D6/486
D. 373,000	8/1996	Brady ....	D26/68
D. 373,912	9/1996	Roig et al. ....	D6/486 X

**OTHER PUBLICATIONS**

HarryGitlin Inc. lighting flyer, indirect lighting fixture, Sep. 1977.

Home Decorators catalog, p. 78, pedestal "H", Jan. 1995.

*Primary Examiner*—Susan J. Lucas

*Attorney, Agent, or Firm*—J. Sanchelima

[57] **CLAIM**

The ornamental design for the lamp, as shown and described.

**DESCRIPTION**

FIG. 1 is a side elevational view of a lamp showing my new design;

FIG. 2 is a bottom plan view thereof;

FIG. 3 is a top plan view thereof;

FIG. 4 is a side elevational view thereof;

FIG. 5 is another side elevational view thereof; and,

FIG. 6 is another side elevational view thereof.

**1 Claim, 2 Drawing Sheets**

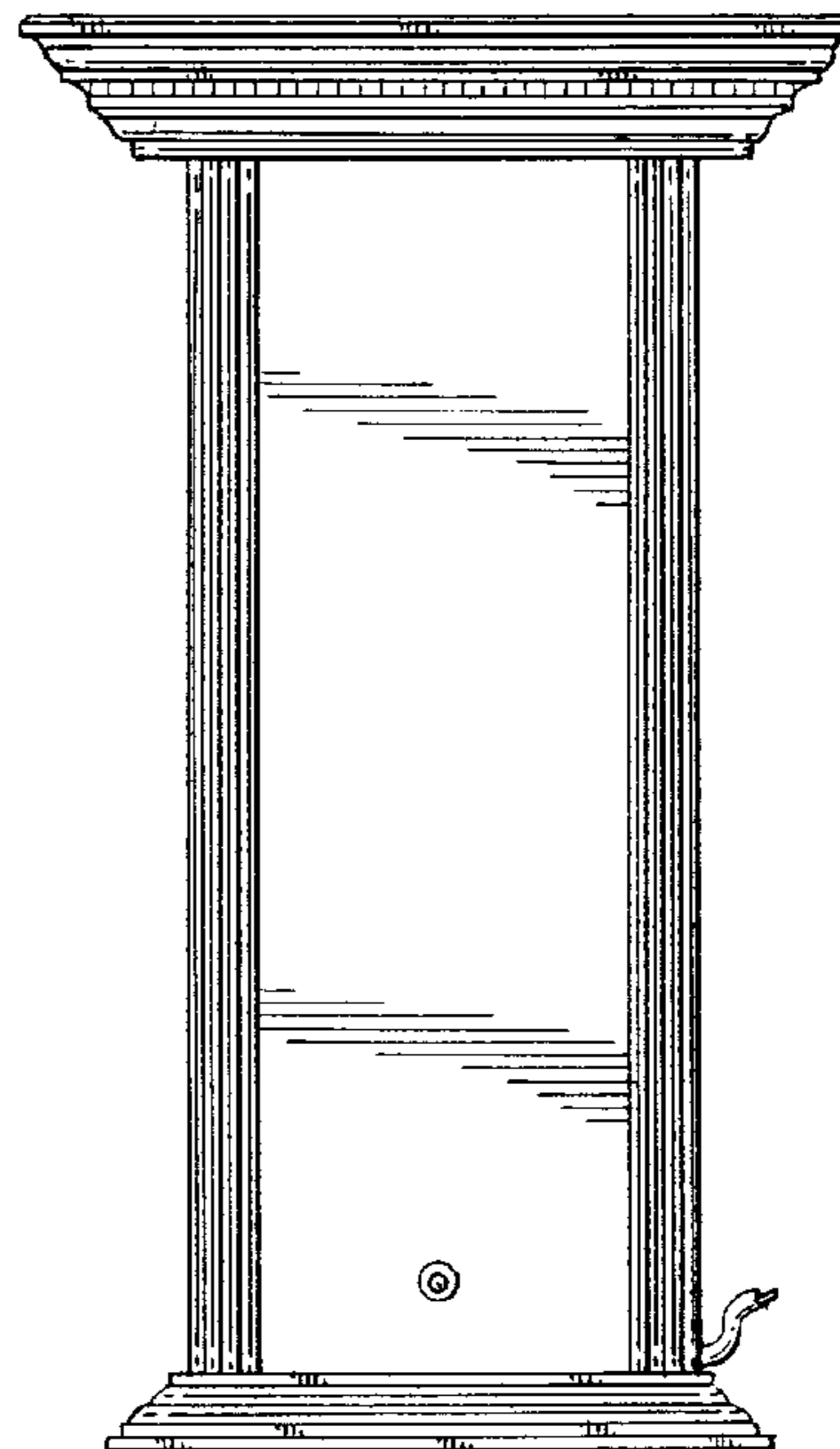
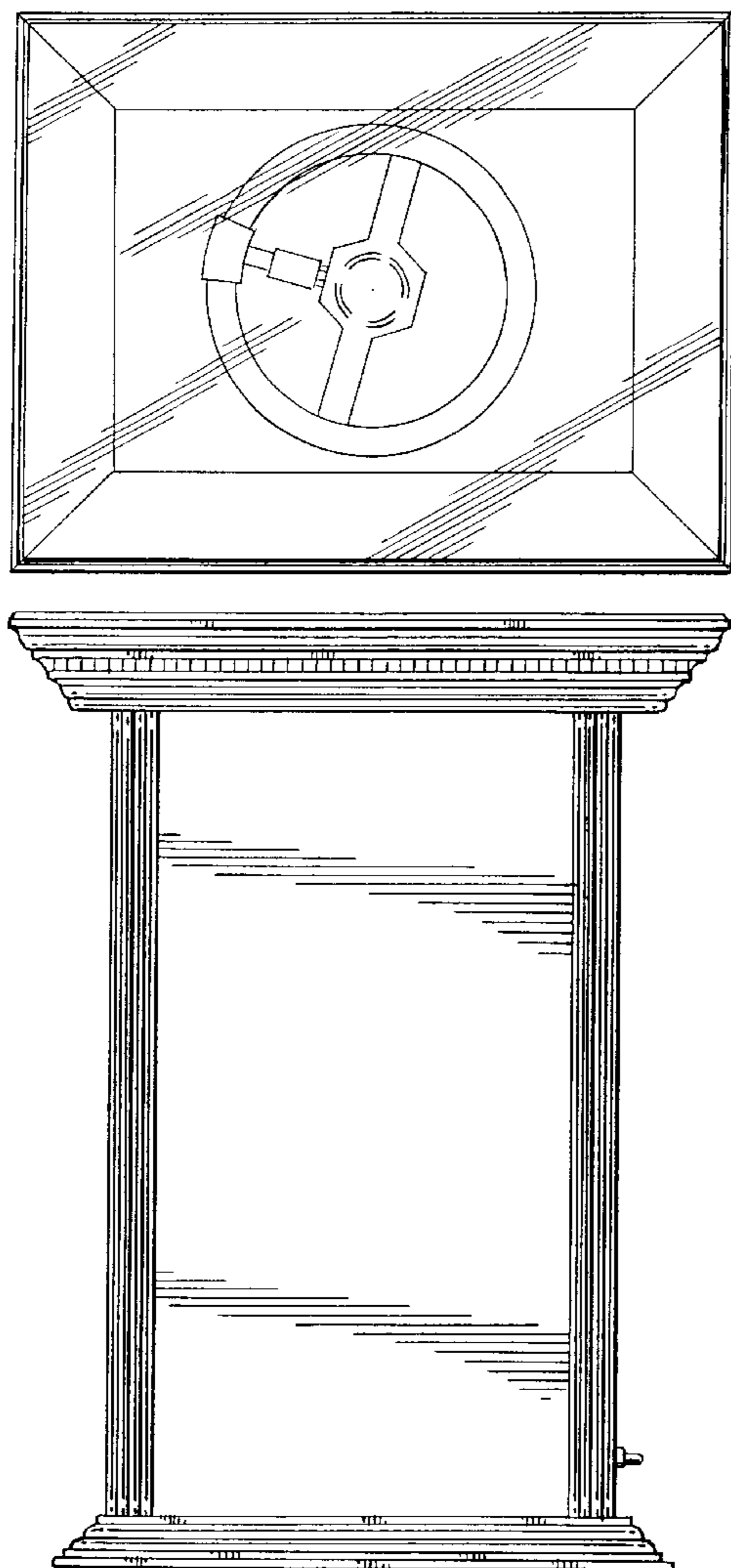

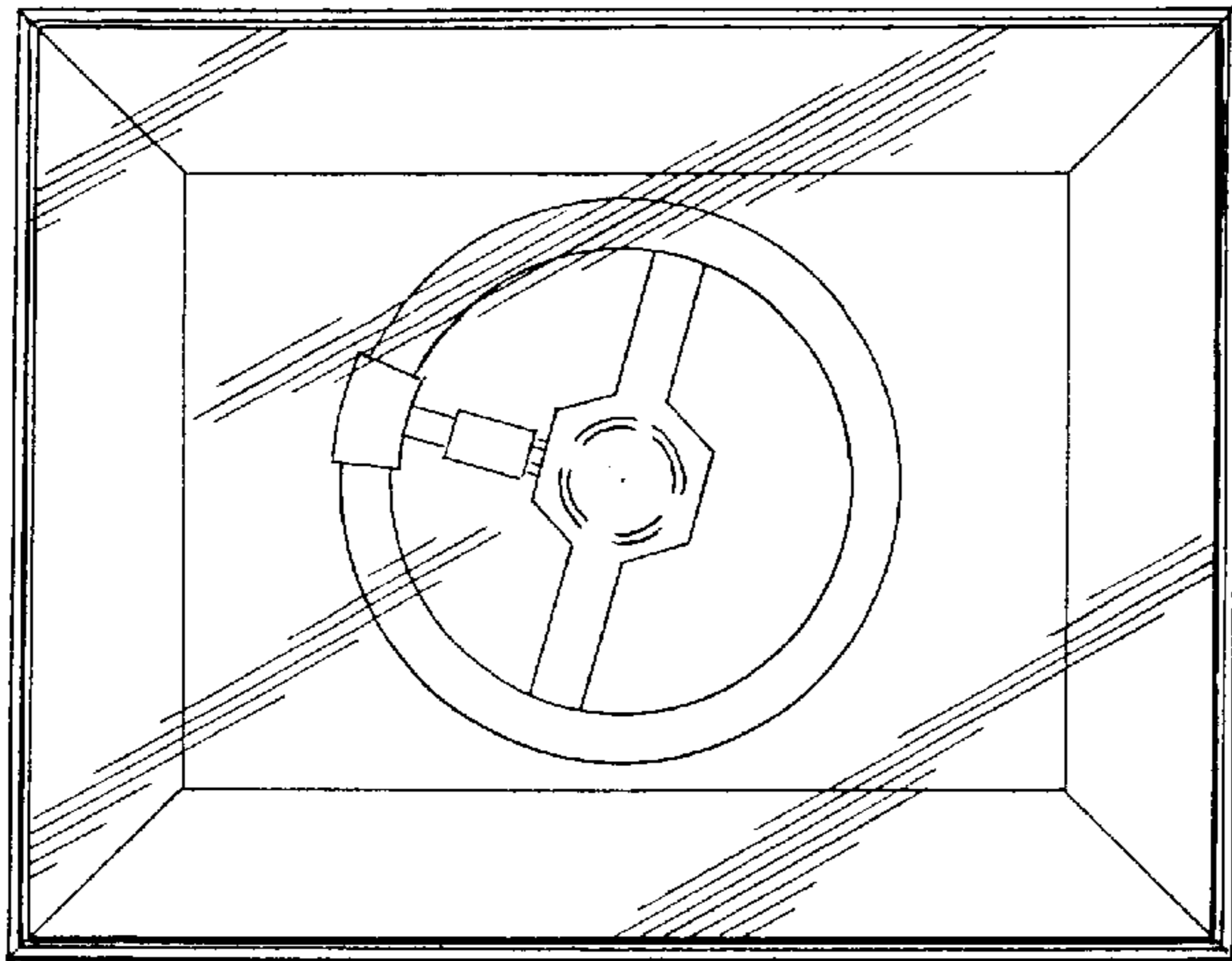

FIG. 3.

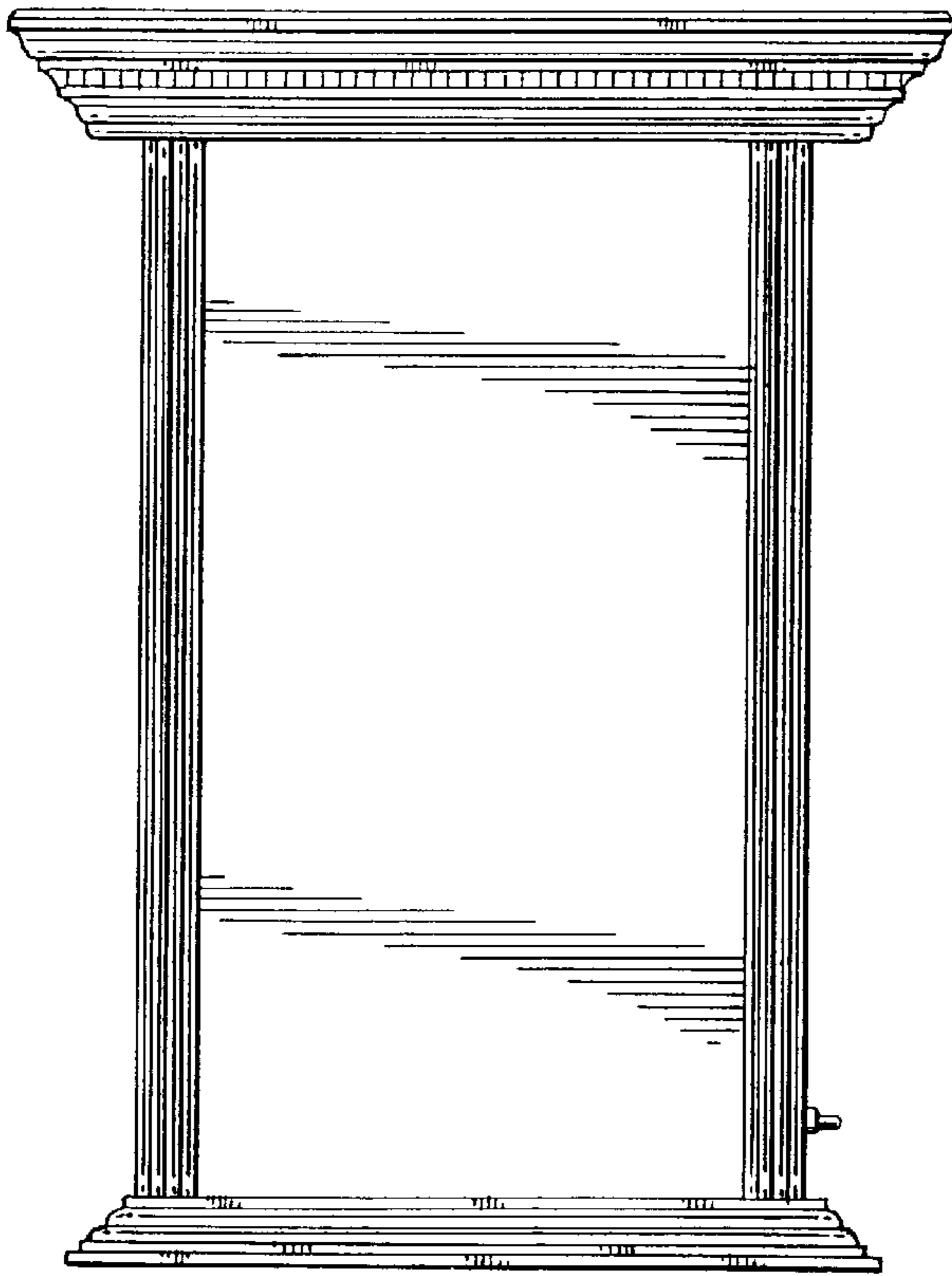

FIG. 1.

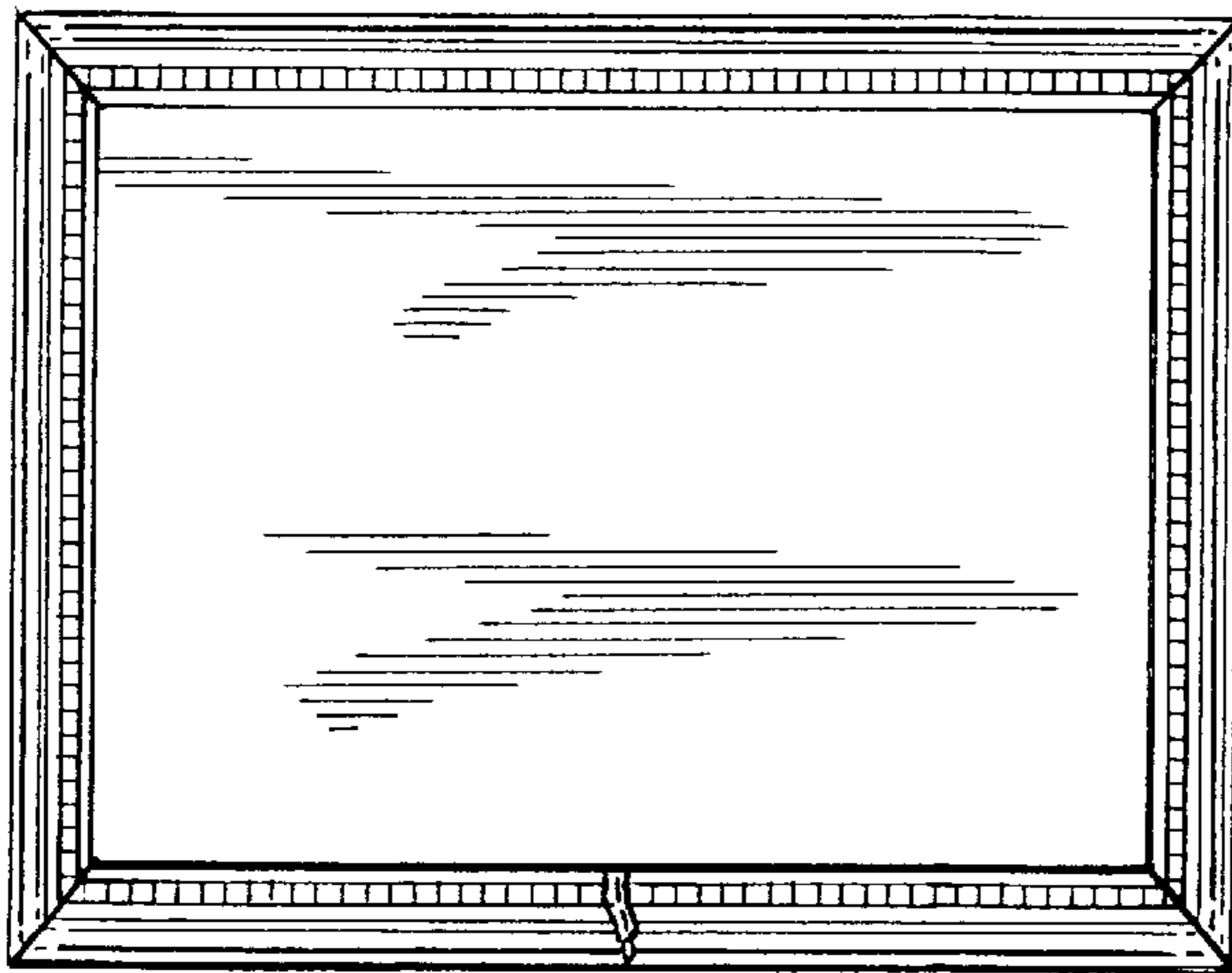

FIG. 2.

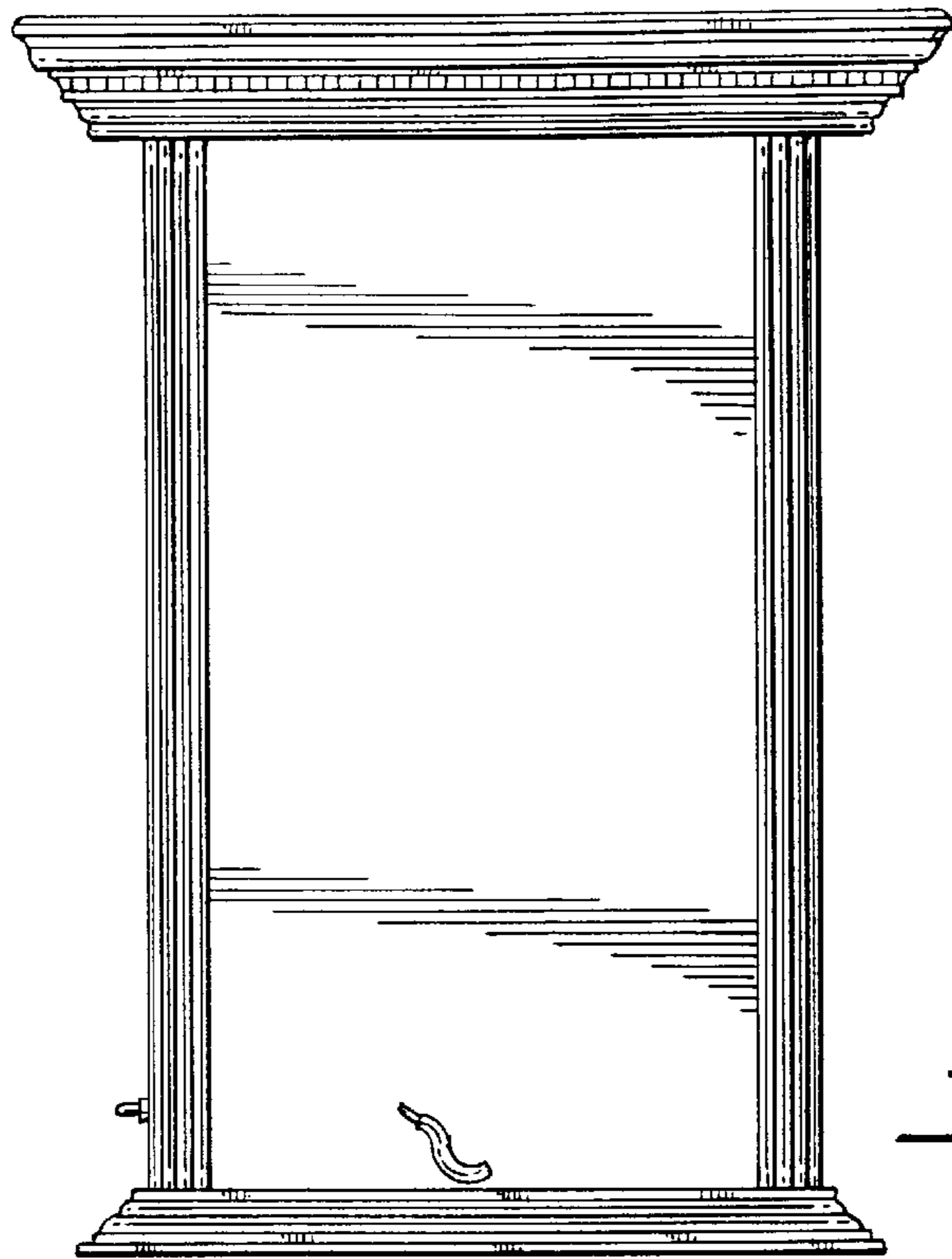

FIG. 4.

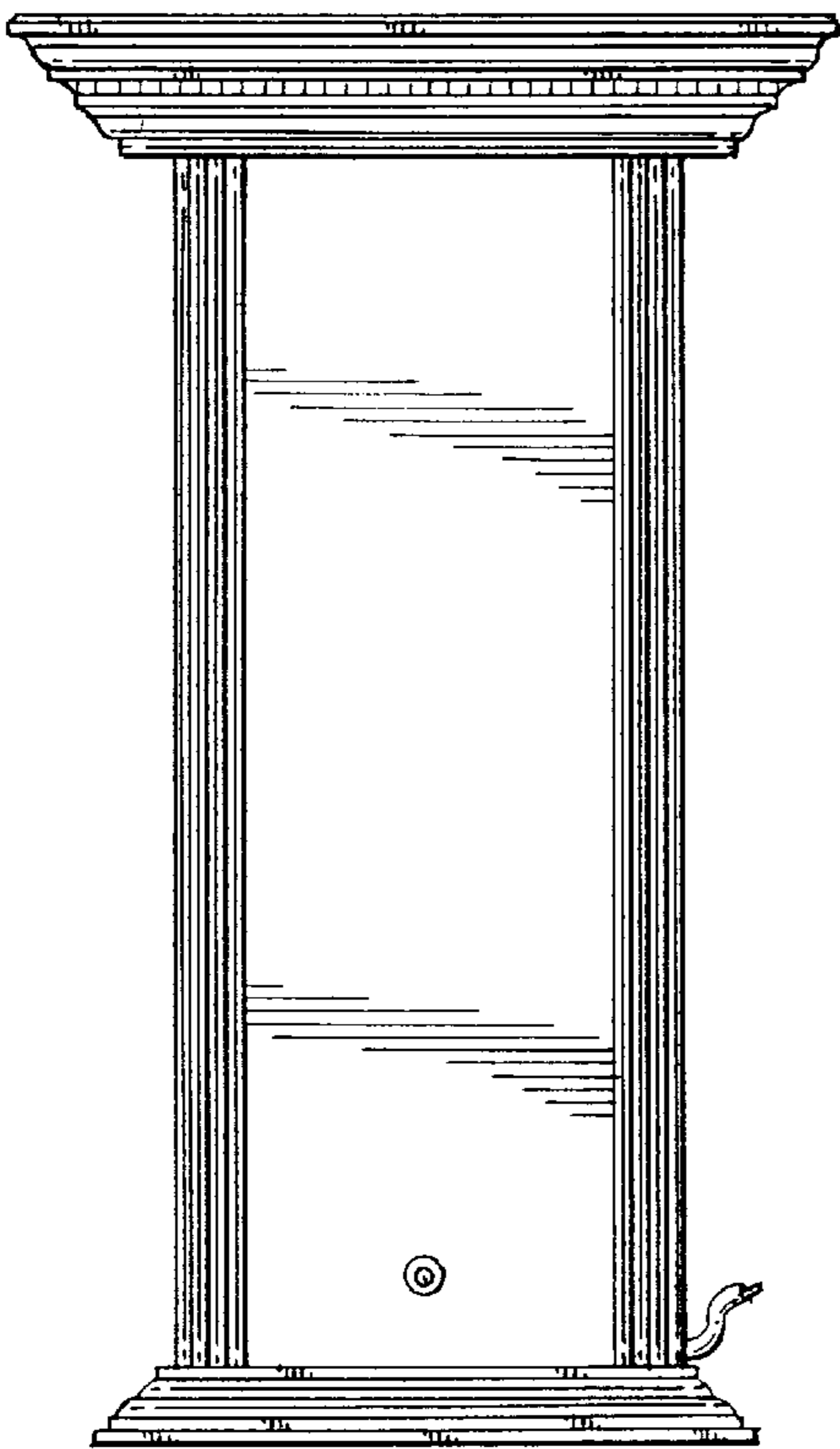

FIG. 5.

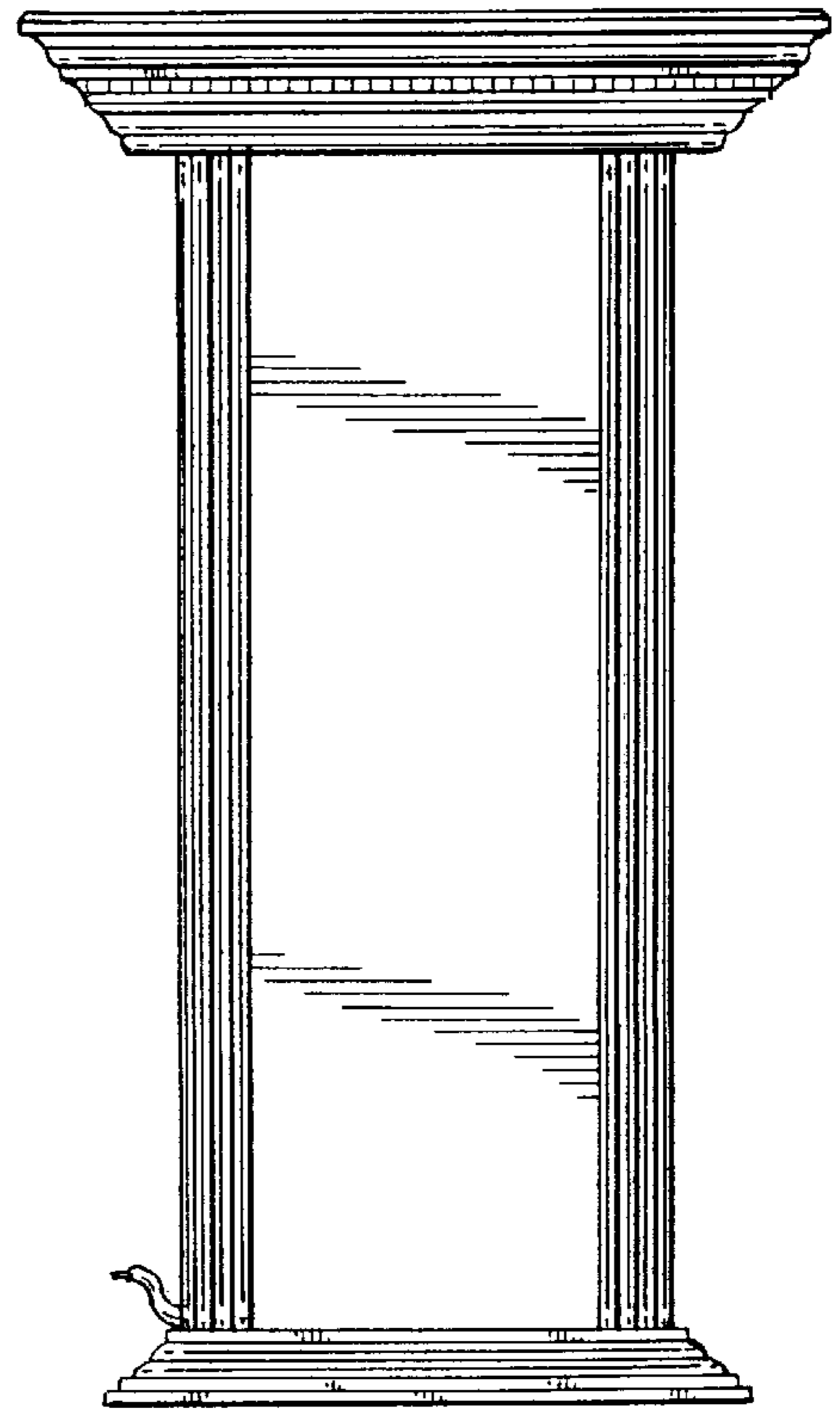

FIG. 6.