



US00D417831S

# United States Patent [19]

Libby et al.

[11] Patent Number: Des. 417,831

[45] Date of Patent: \*\* Dec. 21, 1999

[54] **SLIDING DOOR HANDLE AND LOCK ASSEMBLY**

5,388,875 2/1995 Fleming ..... 292/DIG. 46  
5,595,409 1/1997 Fier ..... 292/DIG. 46

[75] Inventors: **James B. Libby**, Stillwater; **Casey L. Carlson**, Edina, both of Minn.; **Duane T. Fier**, Hudson, Wis.; **Mark S. Hudoba**, Hugo; **Joseph G. Reithmeyer**, Afton, both of Minn.

### OTHER PUBLICATIONS

4 Color Photos of Brass Andersen Lock (on sale and in public use before Dec. 11, 1997).  
4 Color Photos of White Andersen Lock (on sale and in public use before Dec. 11, 1997).

[73] Assignee: **Andersen Corporation**, Bayport, Minn.

*Primary Examiner*—B. J. Bullock  
*Attorney, Agent, or Firm*—Merchant & Gould P.C.

[\*\*] Term: **14 Years**

### [57] CLAIM

[21] Appl. No.: **29/097,720**

The ornamental design for a sliding door handle and lock assembly, as shown and described.

[22] Filed: **Dec. 11, 1998**

### DESCRIPTION

[51] **LOC (6) Cl.** ..... **08-06**

[52] **U.S. Cl.** ..... **D8/302; D8/319; D8/352**

[58] **Field of Search** ..... **D8/301, 302, 315-320, D8/352, 338; 16/110 R, 111 R; 292/336.3, DIG. 46; 70/95-100**

FIG. 1 is a front perspective view of a sliding door handle and lock assembly showing our new design; FIG. 2 is a rear perspective view thereof; FIG. 3 is a front elevational view thereof, the opposite handle and lock assembly omitted for ease of illustration; FIG. 4 is a rear elevational view thereof, the opposite handle and lock assembly omitted for ease of illustration; FIG. 5 is a right side elevational view thereof; FIG. 6 is a left side elevational view thereof; FIG. 7 is a top plan view thereof; and, FIG. 8 is a bottom plan view thereof.

### [56] References Cited

#### U.S. PATENT DOCUMENTS

- D. 300,719 4/1989 Rhoades et al. .
- D. 320,334 10/1991 Clancy .
- D. 339,280 9/1993 Bray et al. .... D8/301
- D. 340,179 10/1993 Mirick et al. .... D8/301
- D. 340,398 10/1993 Clancy .
- D. 384,266 9/1997 Mantarakis et al. .... D8/301
- D. 384,568 10/1997 Mantarakis et al. .... D8/301
- D. 397,604 9/1998 Libby et al. .
- 3,353,855 11/1967 Smith .

The broken line showing of a portion of a door in FIGS. 1, 2 and 5-8 is for illustrative purposes only and forms no part of the claimed design.

**1 Claim, 6 Drawing Sheets**

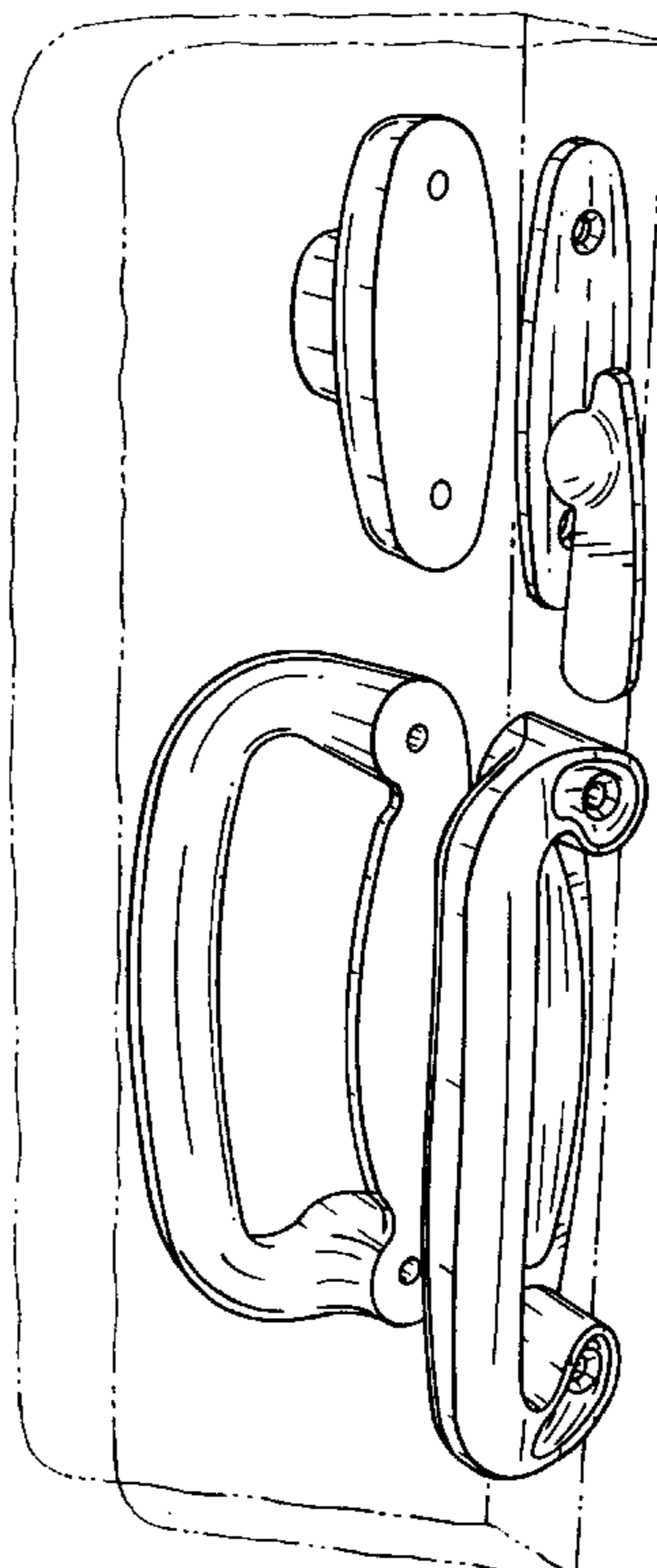
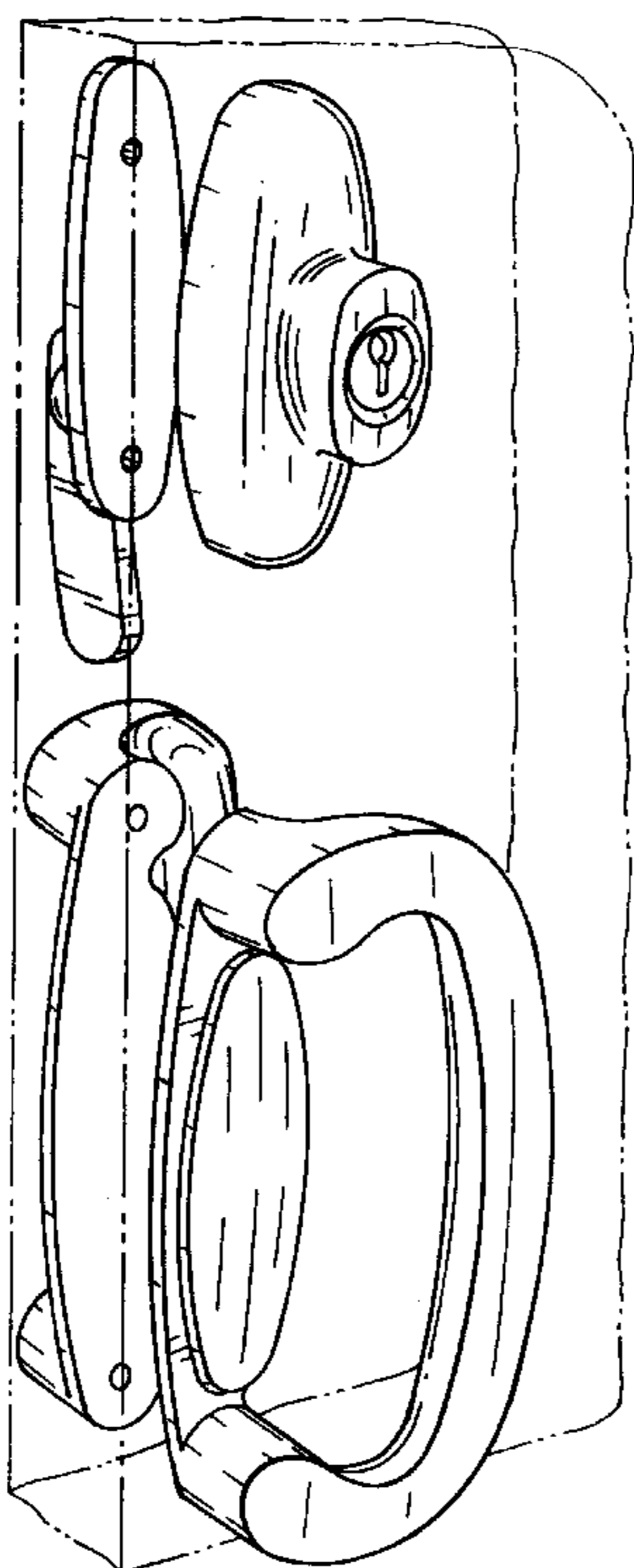

FIG. 1

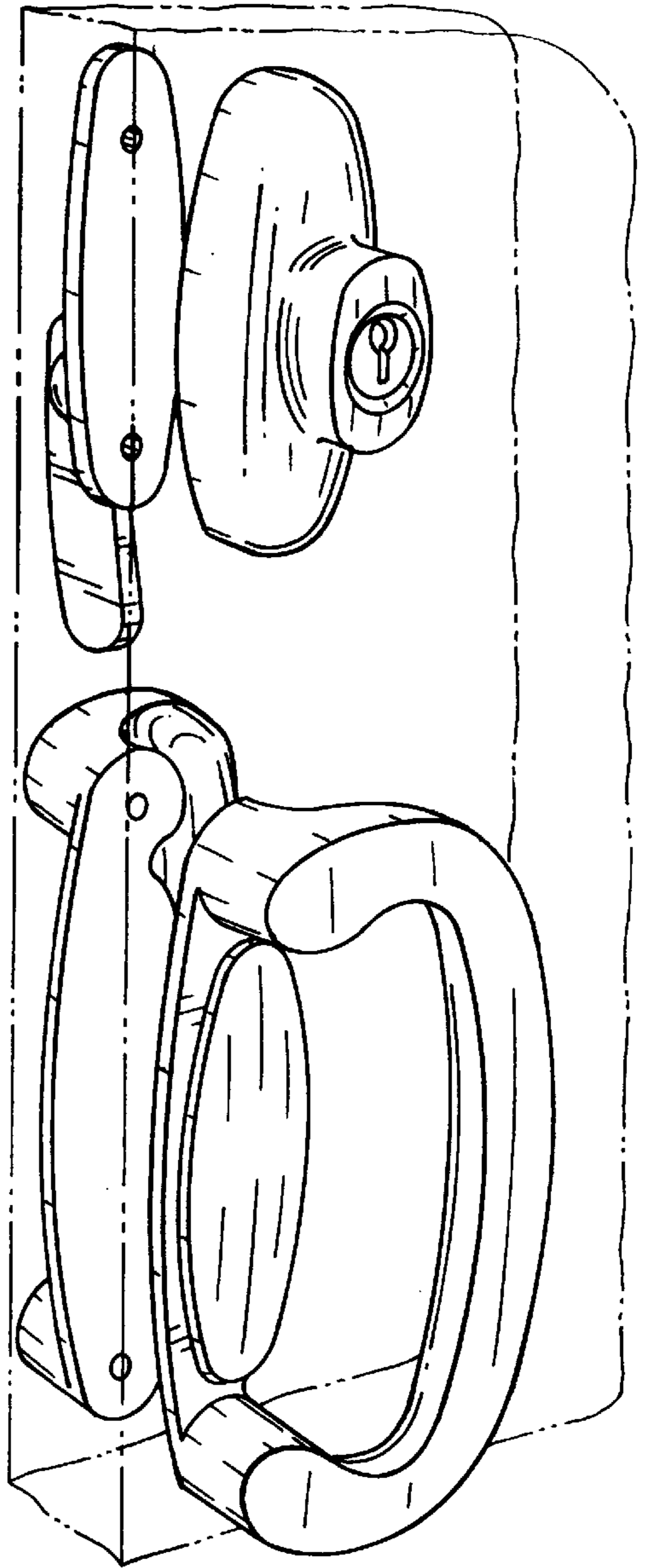

FIG. 2

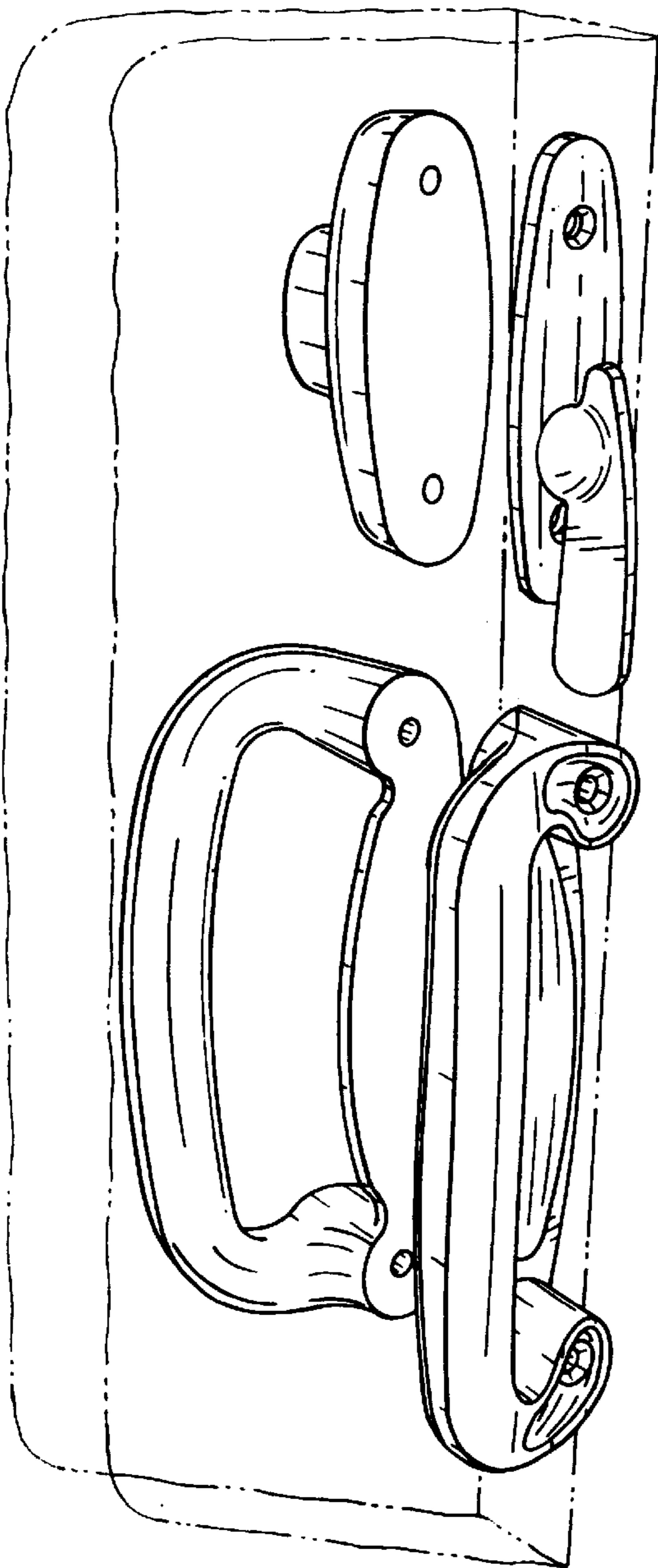

FIG. 3

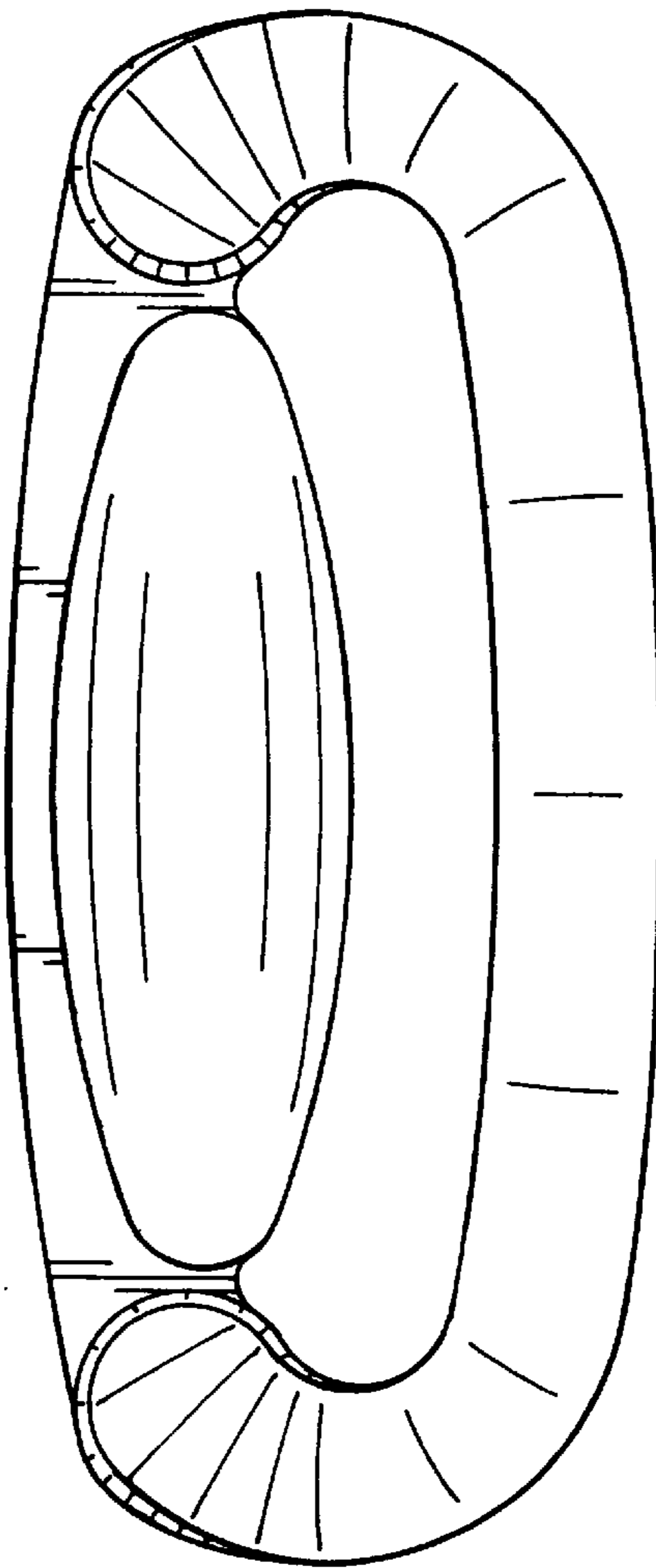
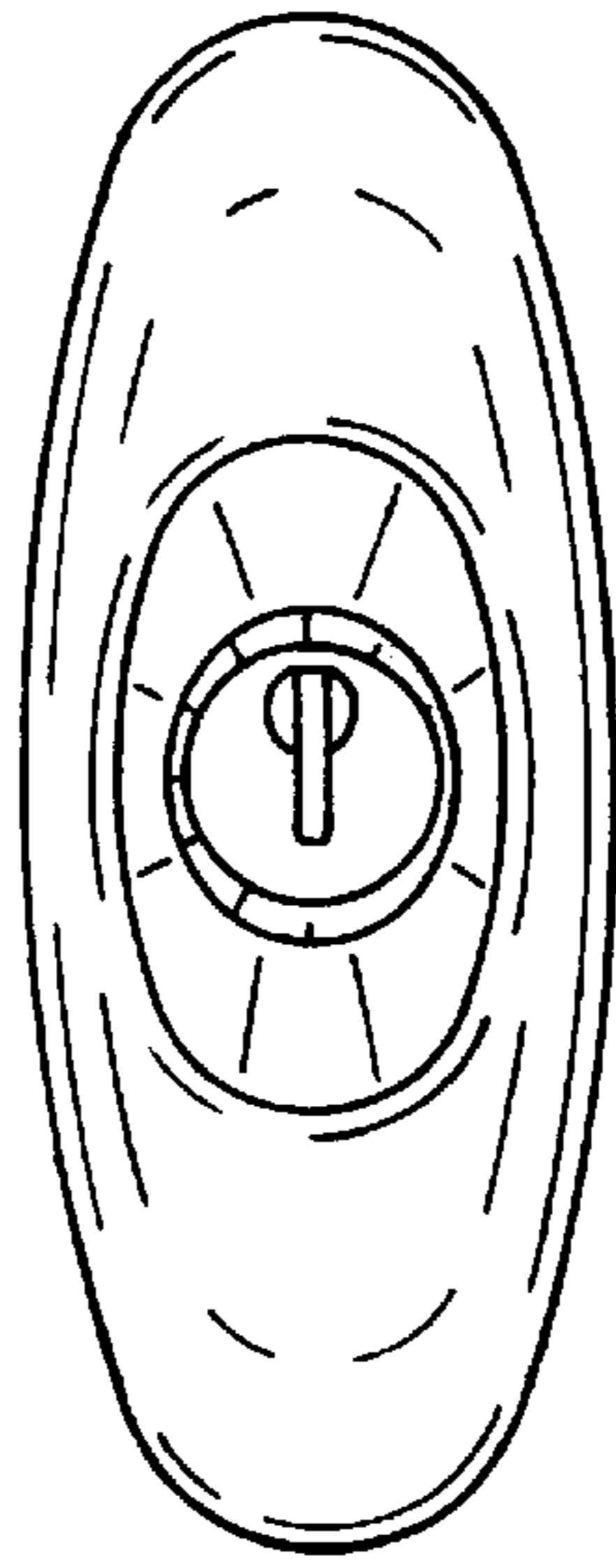

FIG. 4

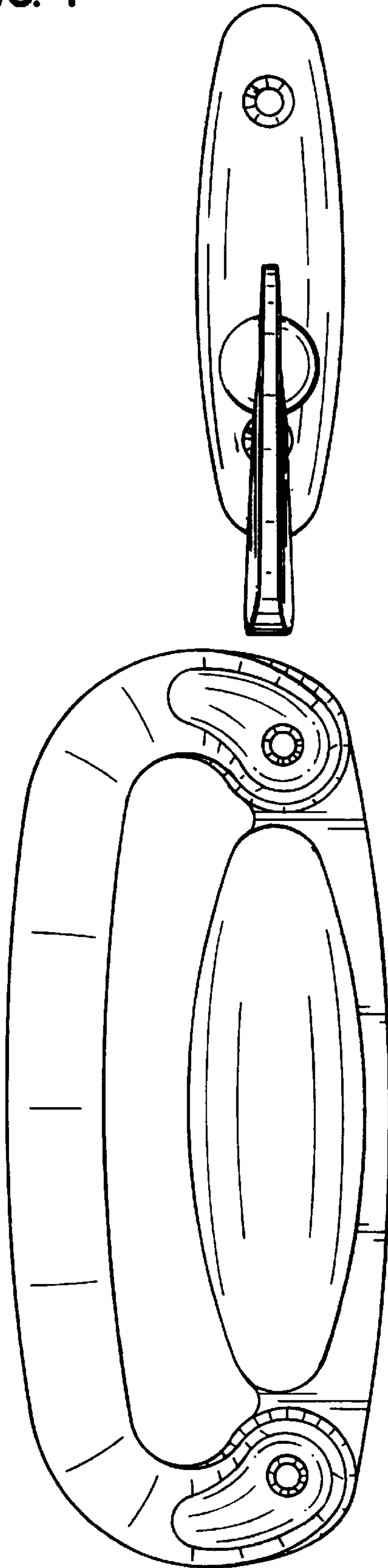

FIG. 5

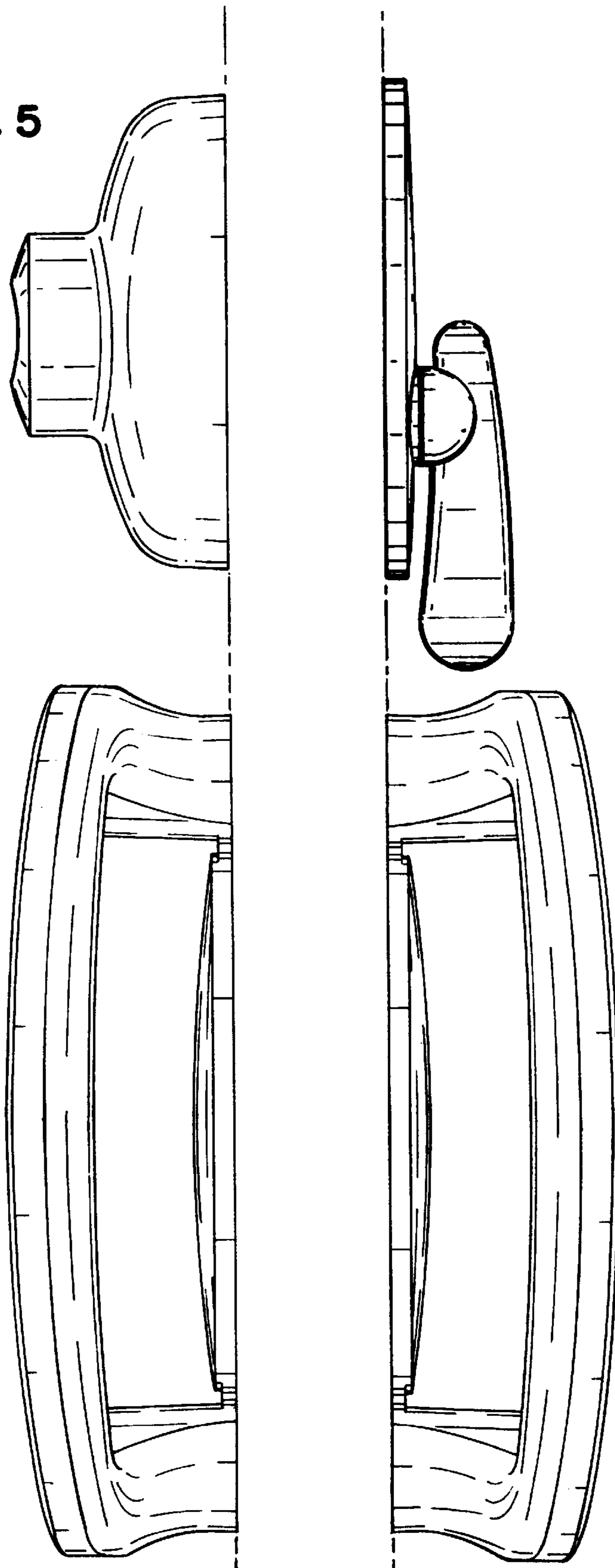

FIG. 6

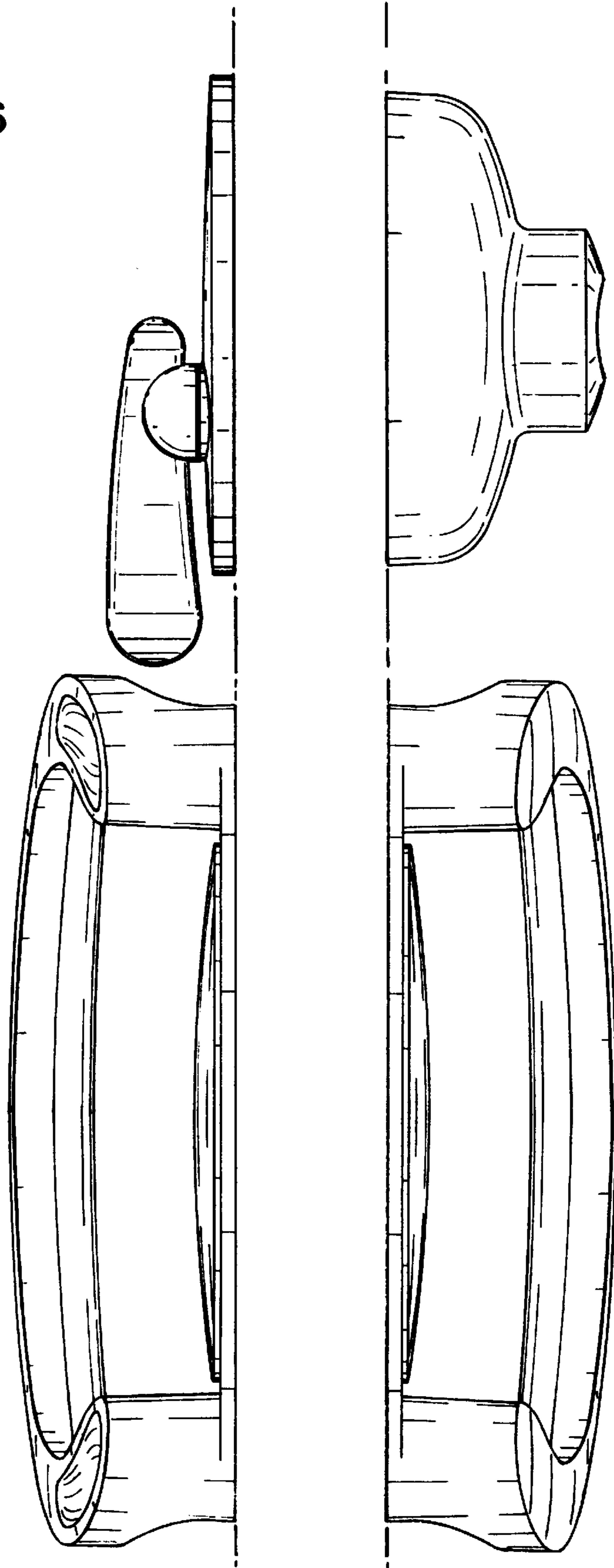

FIG. 7

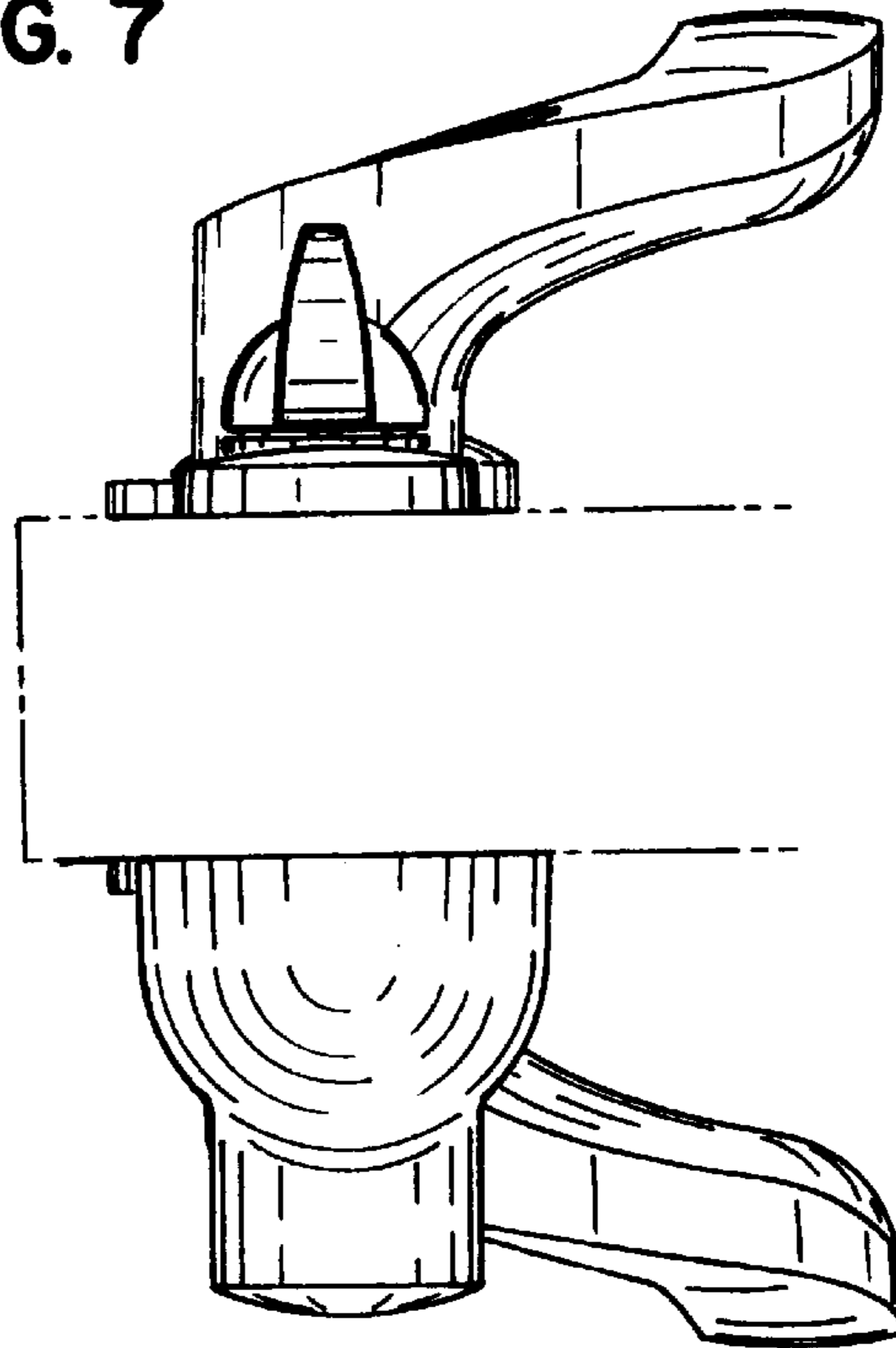

FIG. 8

