



US00D417816S

United States Patent [19] Kari

[11] Patent Number: Des. 417,816

[45] Date of Patent: ** Dec. 21, 1999

[54] TRIVET

[75] Inventor: **Kathy Kari**, Lisle, Ill.

[73] Assignee: **The Pampered Chef, Ltd.**, Addison, Ill.

[**] Term: **14 Years**

[21] Appl. No.: **29/084,327**

[22] Filed: **Feb. 27, 1998**

[51] LOC (6) Cl. **07-99**

[52] U.S. Cl. **D7/388; D7/545; D7/554.3**

[58] Field of Search D7/388, 396.1, D7/698, 672, 673, 553.3, 554.3, 543, 545, 708; 248/150; 269/900, 289 R; D34/38

[56] References Cited

U.S. PATENT DOCUMENTS

D. 101,465	10/1936	Knapp	D7/545
D. 232,340	8/1974	Lax	D7/708
D. 256,007	7/1980	Chillog	D34/38
D. 267,462	1/1983	Kneale, III	D7/545
D. 388,278	12/1997	Howitt	D7/388
D. 394,988	6/1998	Emerson	D7/698
D. 409,814	5/1999	Herring	D34/38

Primary Examiner—M. N. Pandozzi
Attorney, Agent, or Firm—Olson & Hierl, Ltd.

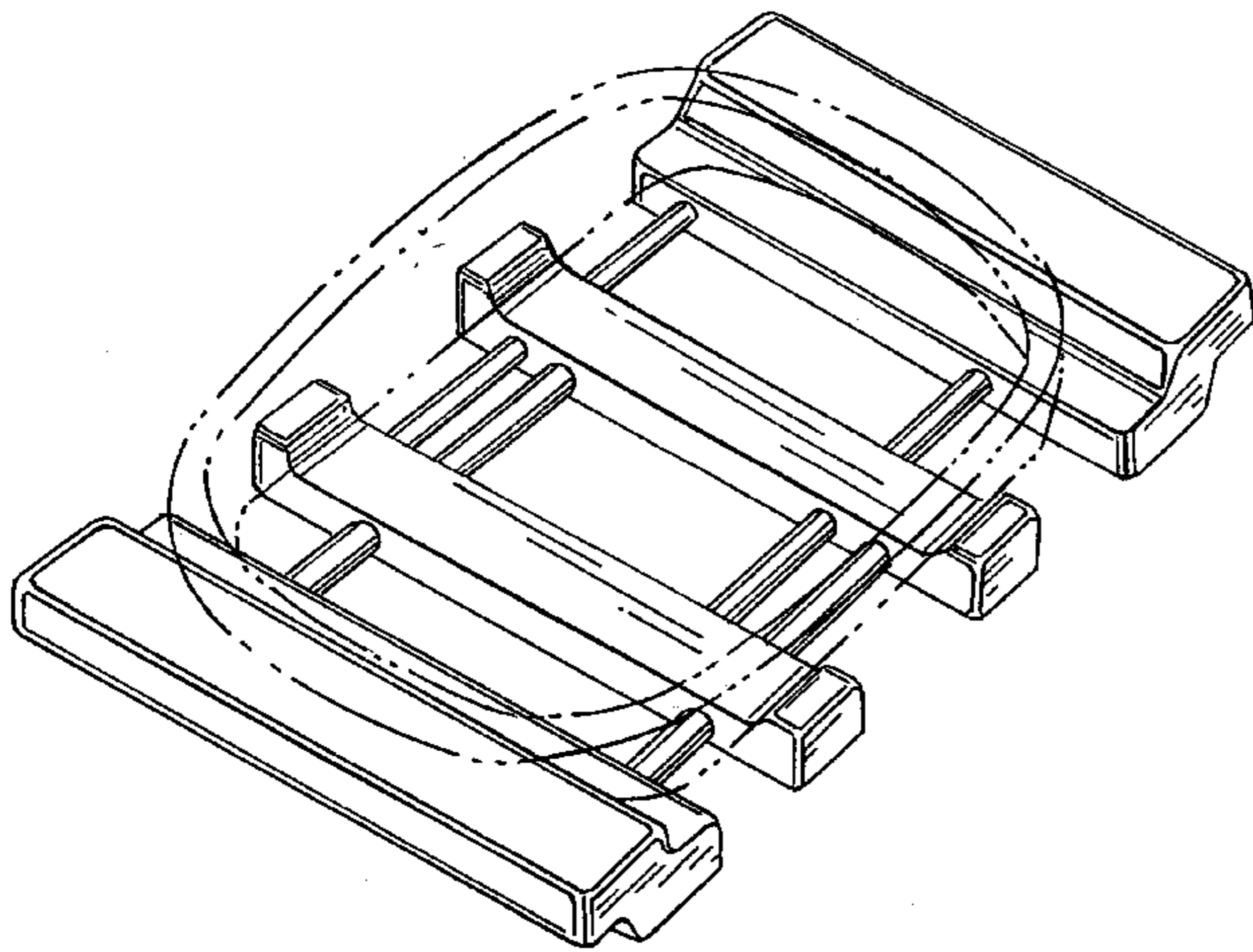

[57] CLAIM

The ornamental design for a trivet, as shown and described.

DESCRIPTION

FIG. 1 is a perspective view of a trivet showing a first embodiment of my new design with a tray shown in phantom;

FIG. 2 is a top plan view thereof;

FIG. 3 is a side elevational view, the opposite side view being a mirror image thereof;

FIG. 4 is a bottom plan view thereof;

FIG. 5 is a front elevational view, the rear elevational view being a mirror image thereof;

FIG. 6 is a top plan view of a second embodiment of my new design;

FIG. 7 is a side elevational view, the opposite side elevational view being a mirror image thereof;

FIG. 8 is a bottom view thereof;

FIG. 9 is a front elevational view, the rear elevational view being a mirror image thereof;

FIG. 10 is a top plan view of a third embodiment of my new design;

FIG. 11 is a side elevational view, the opposite side elevational view being a mirror image thereof;

FIG. 12 is a bottom plan view thereof; and,

FIG. 13 is a front elevational view, the rear elevational view being a mirror image thereof.

The broken lines in FIG. 1 are for illustrative purposes only and form no part of the claimed design.

1 Claim, 5 Drawing Sheets

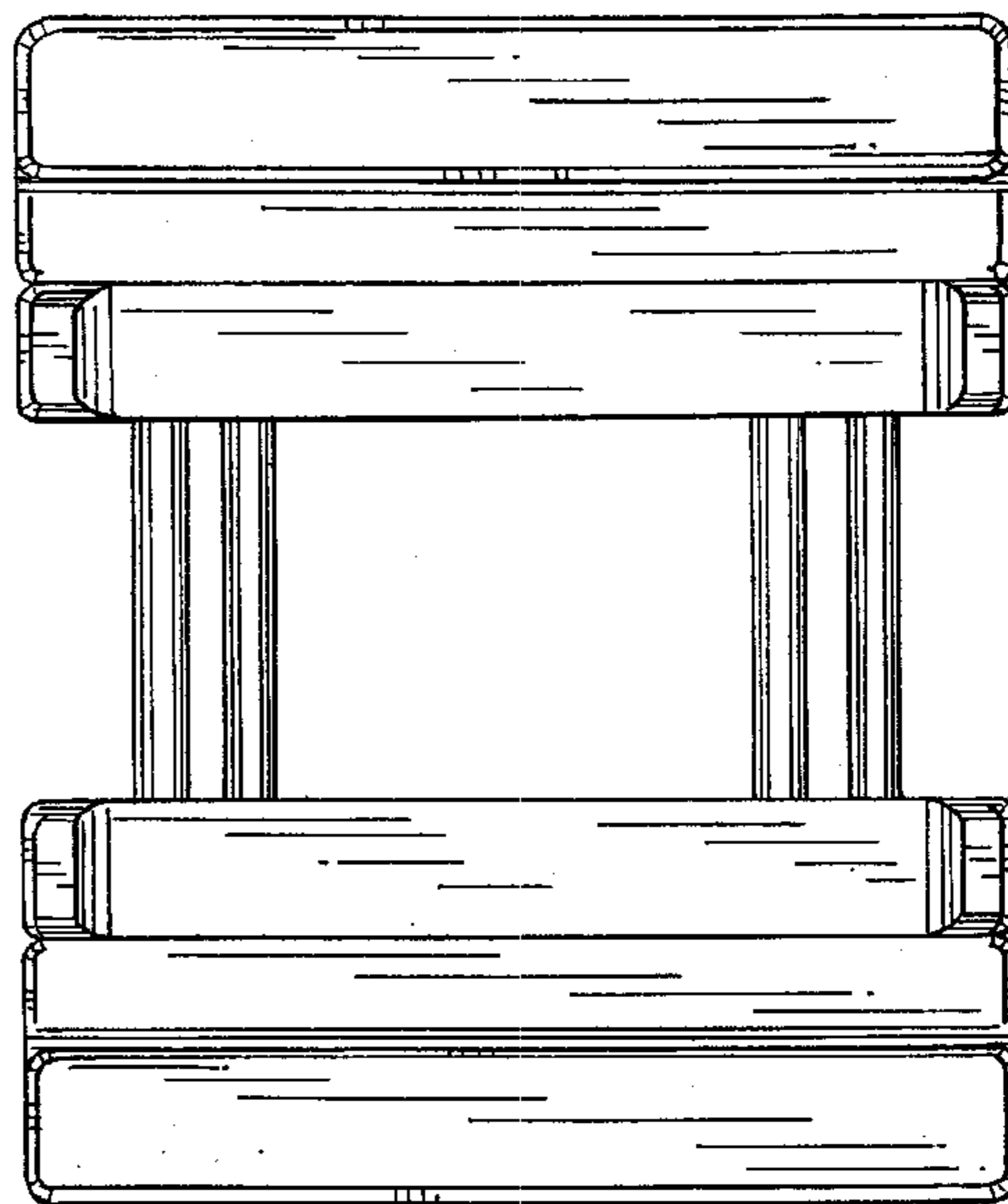

FIG. 1

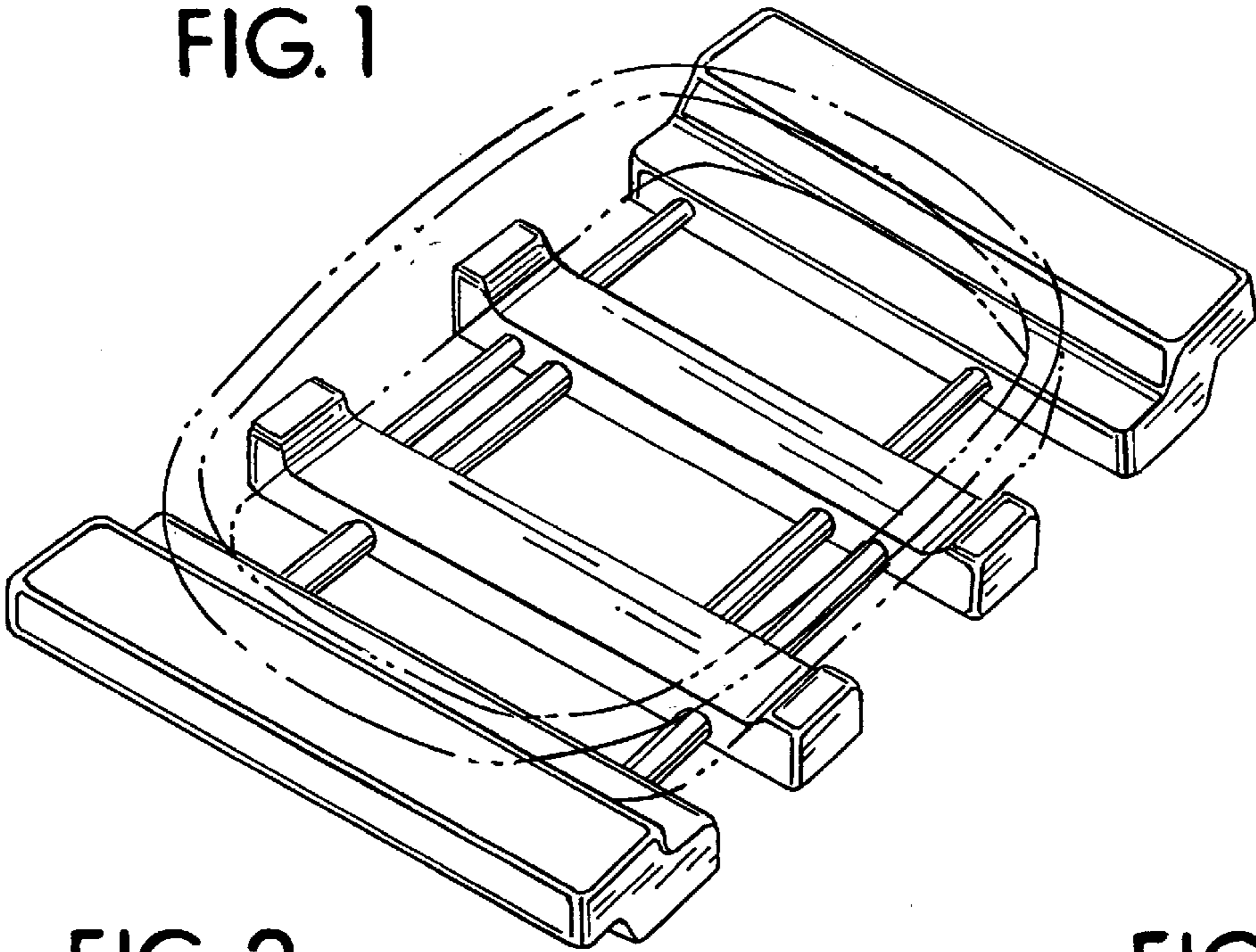

FIG. 2

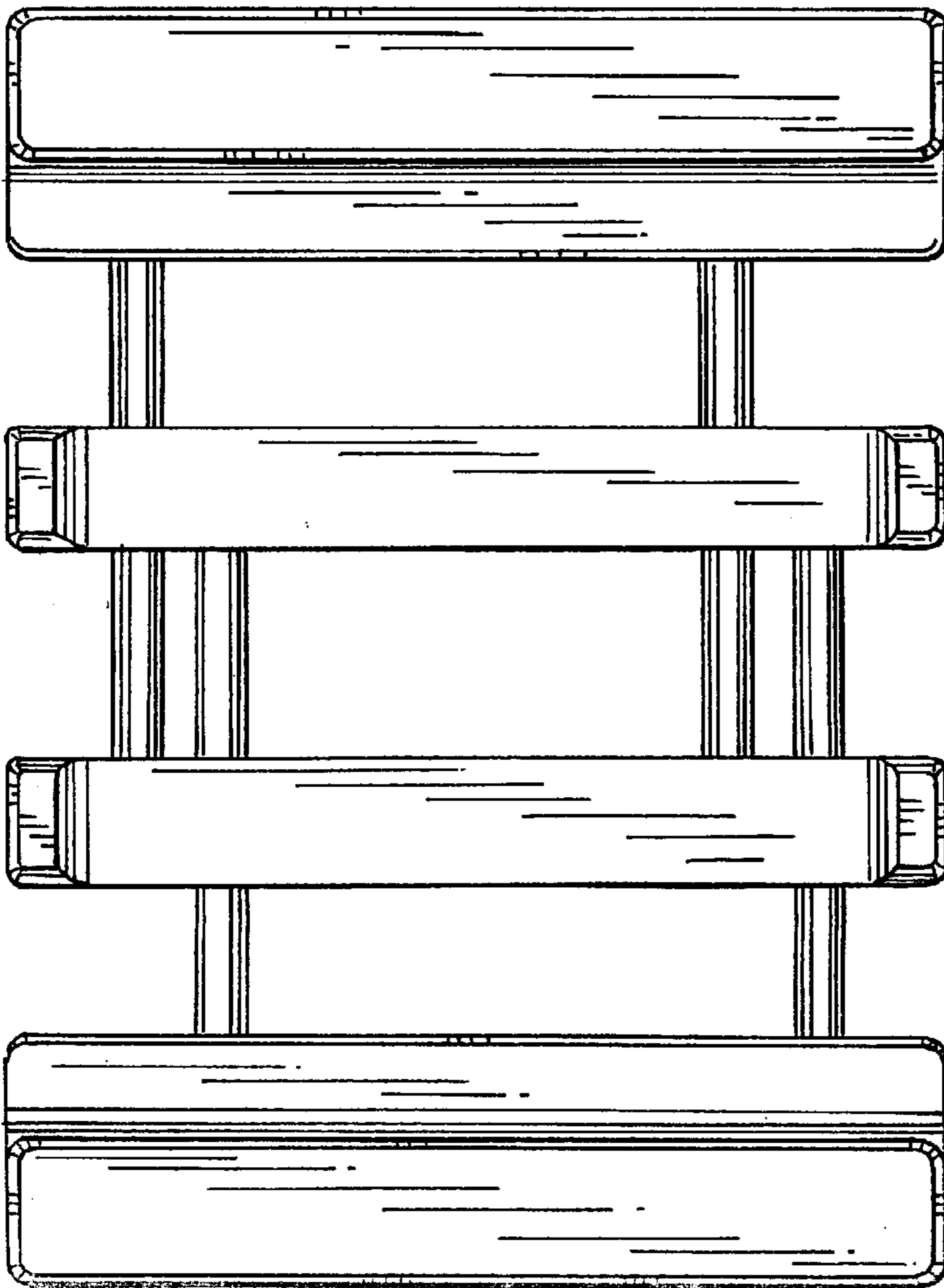

FIG. 3

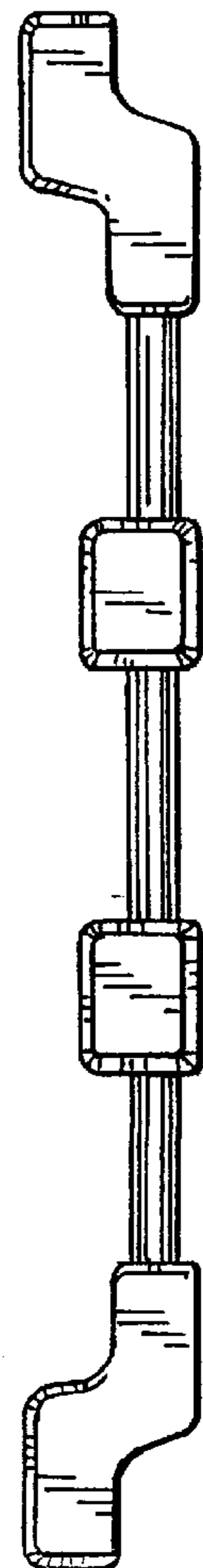

FIG. 4

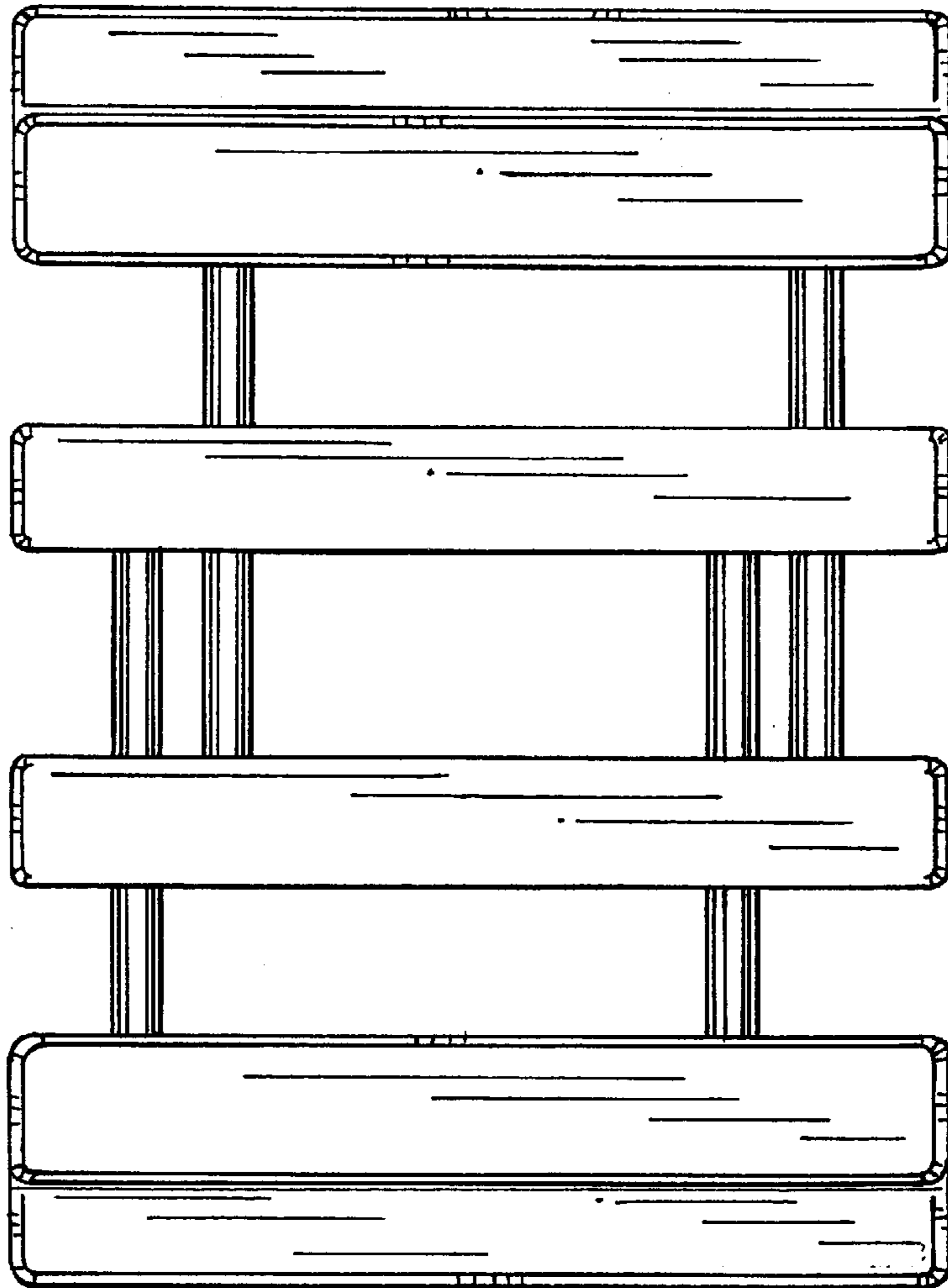

FIG. 5

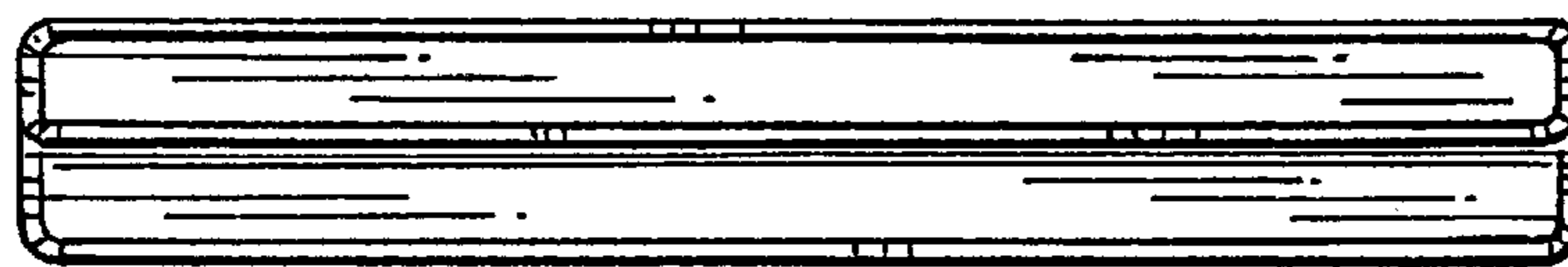

FIG. 9

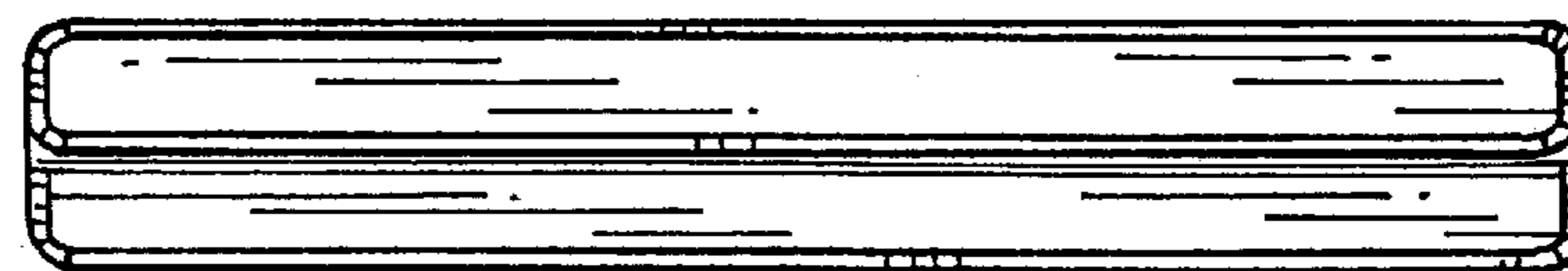

FIG. 7

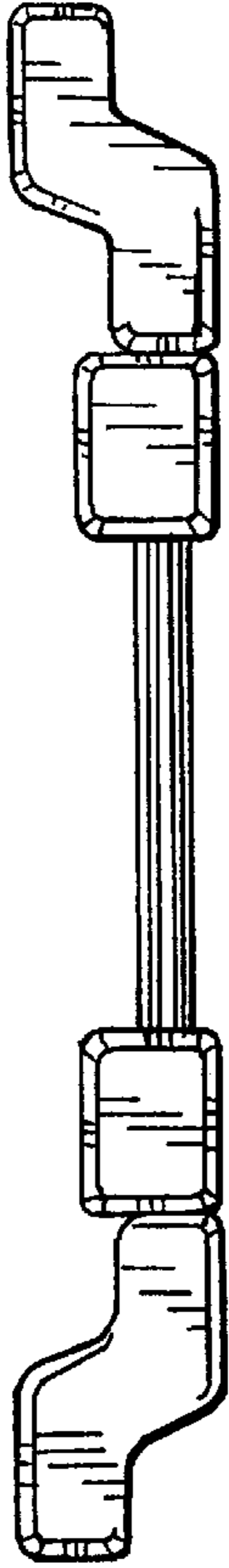

FIG. 6

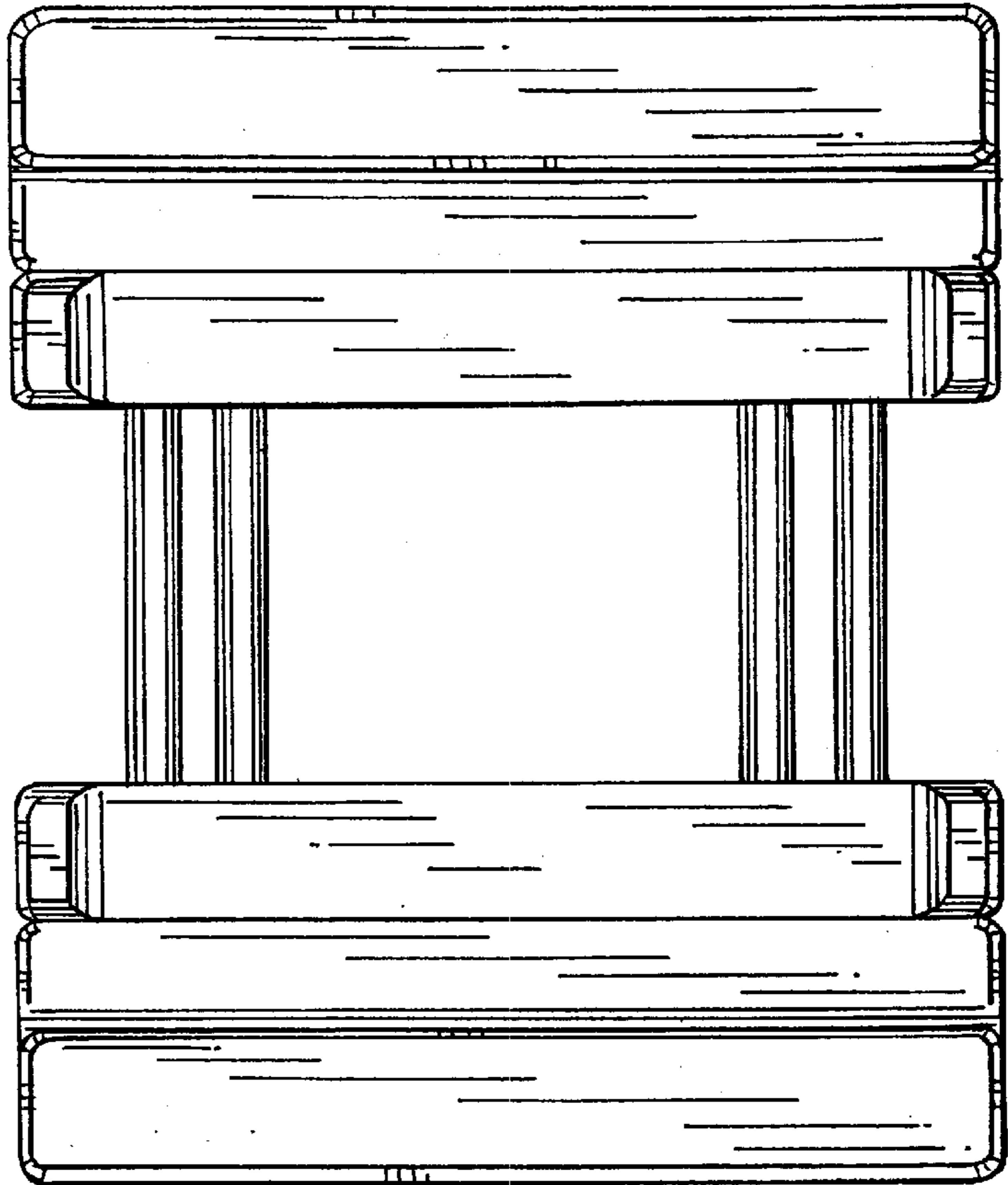

FIG. 8

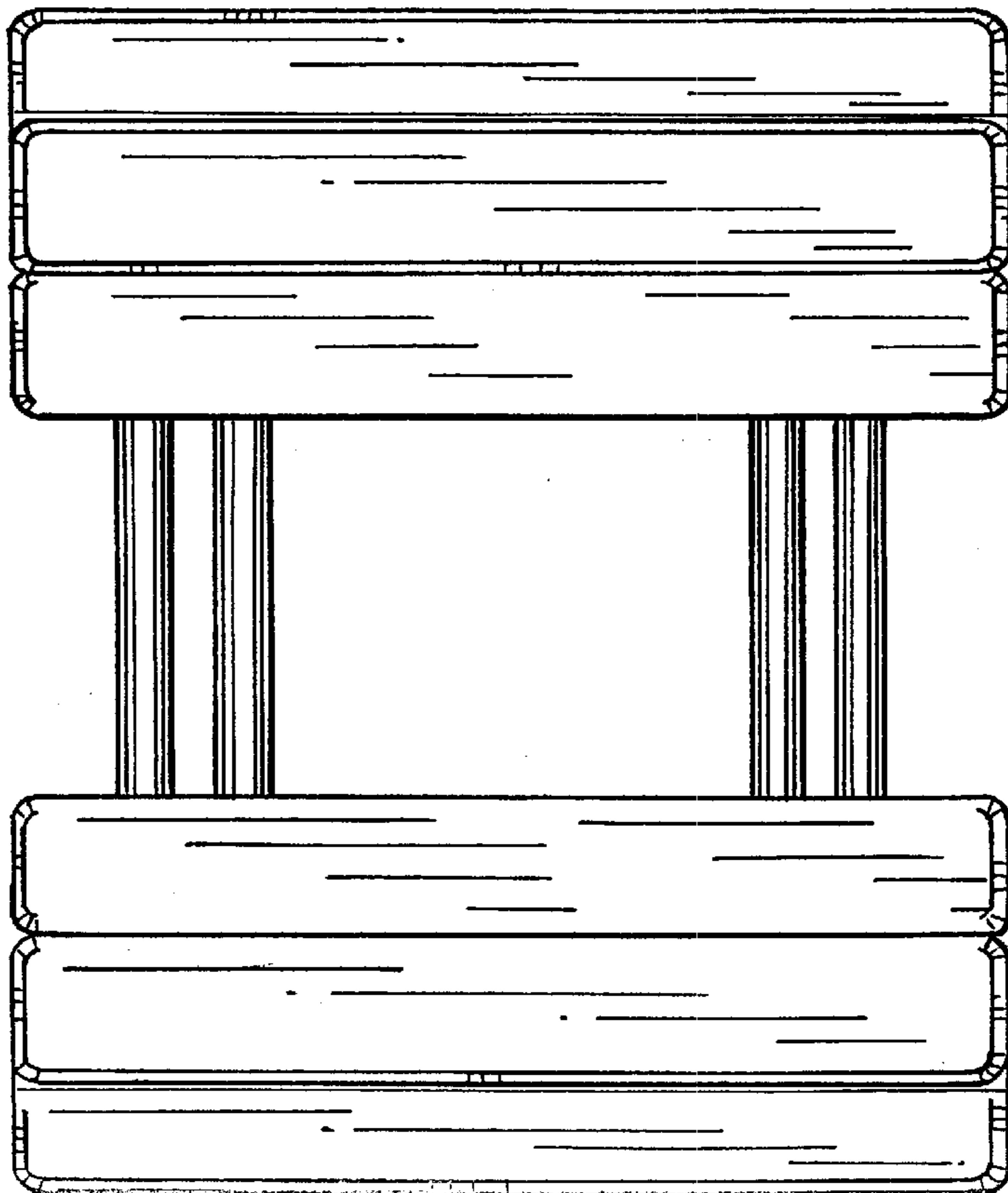

FIG. 10

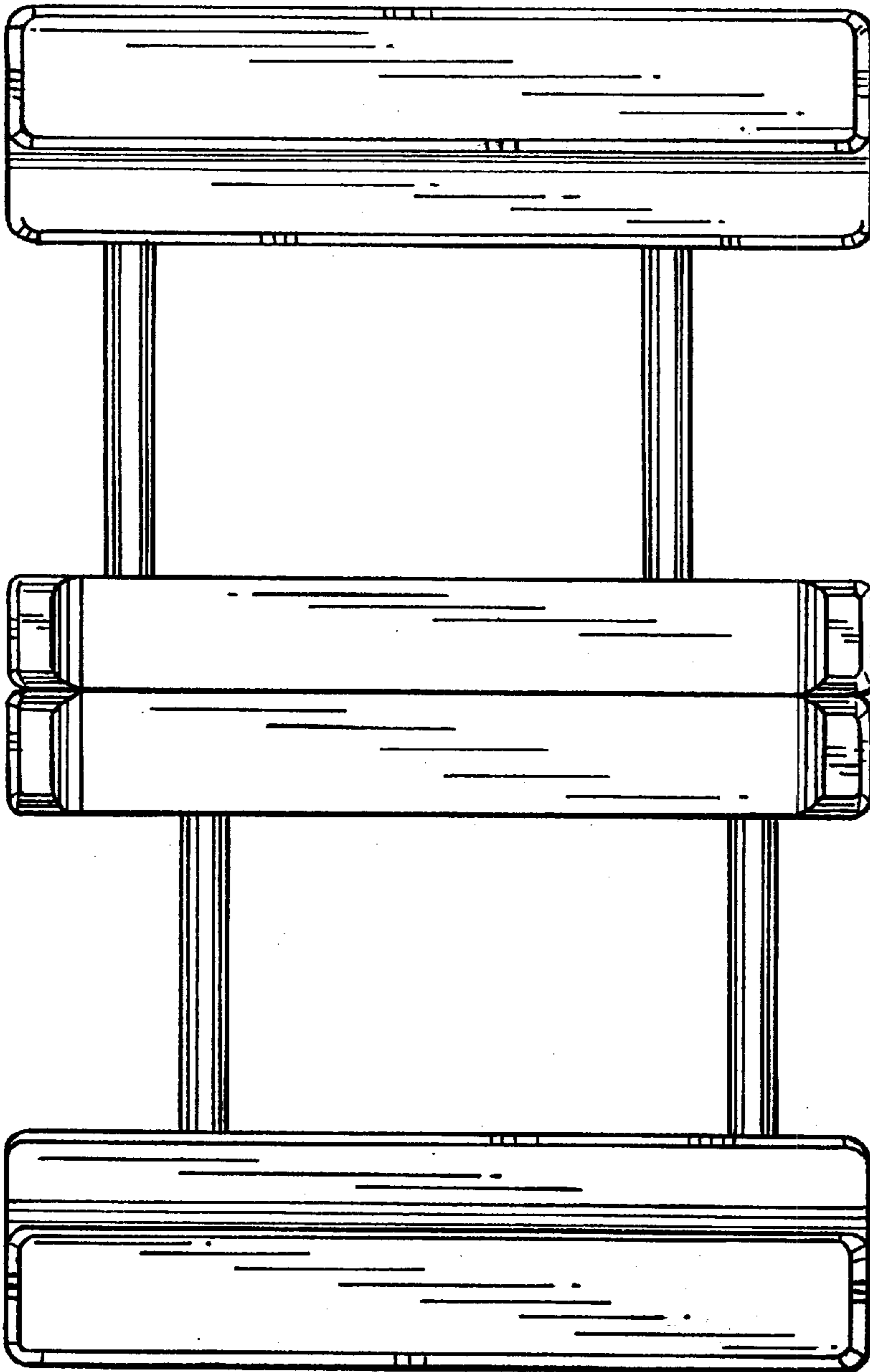

FIG. 11

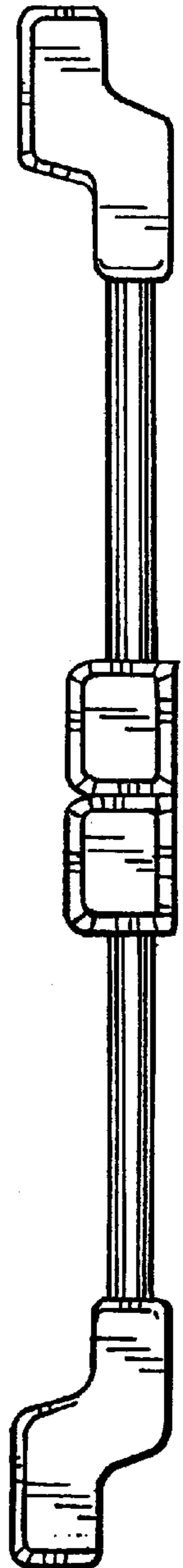

FIG. 12

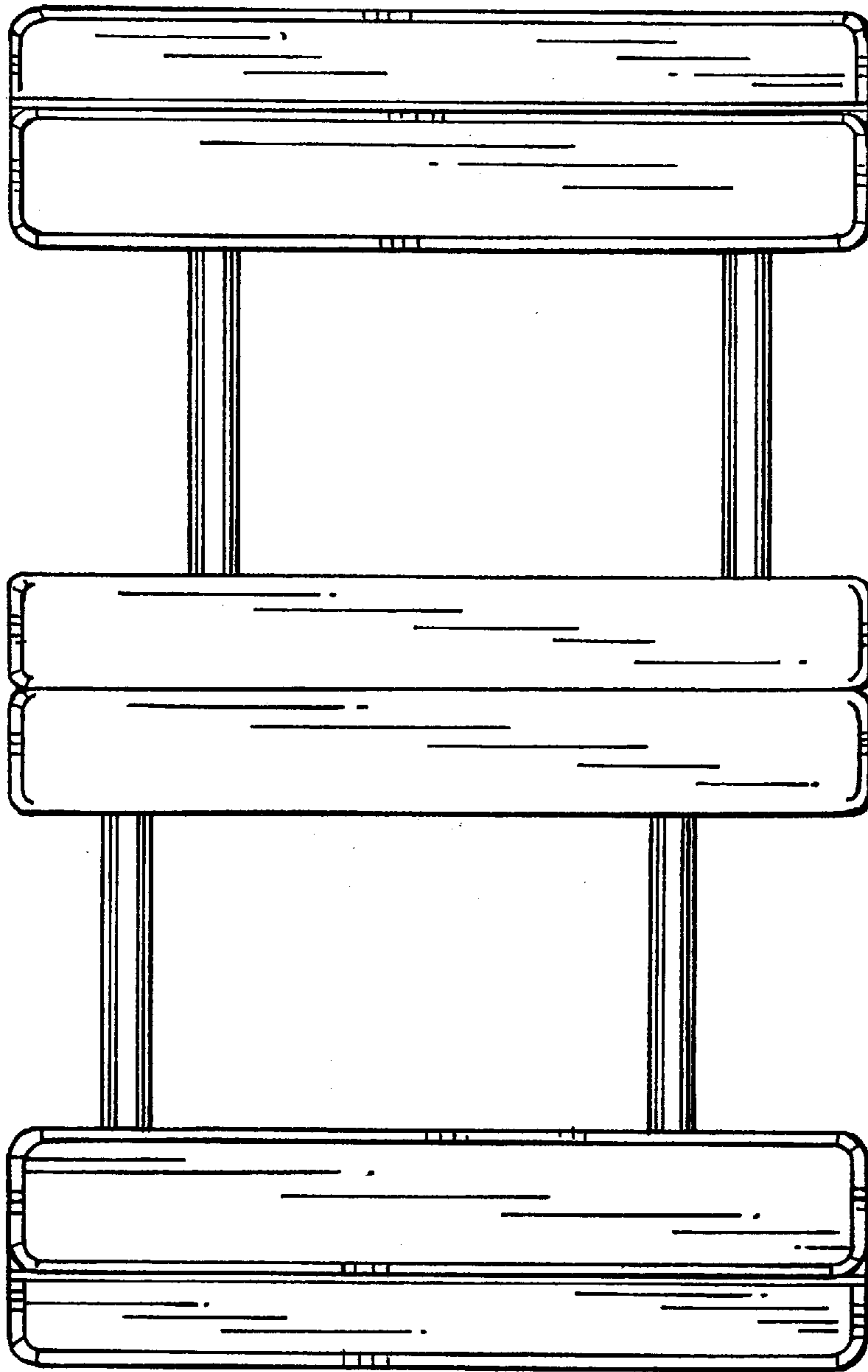

FIG. 13

