



US00D417812S

United States Patent [19]
Rubin

[11] **Patent Number: Des. 417,812**

[45] **Date of Patent: ** Dec. 21, 1999**

[54] **COMBINED DIGITAL DISK PACK AND INSERT**

[75] Inventor: **Michael Rubin**, Hallandale, Fla.

[73] Assignee: **Universal Technology Corp.**, Freeport, Bahamas

[**] Term: **14 Years**

[21] Appl. No.: **29/073,477**

[22] Filed: **Jul. 9, 1997**

[51] **LOC (6) Cl.** **06-04**

[52] **U.S. Cl.** **D6/632; D6/407**

[58] **Field of Search** D6/407, 631, 632, D6/633, 634; D3/201, 301, 245, 289; 206/308.1, 309, 310, 311, 312

[56] **References Cited**

U.S. PATENT DOCUMENTS

D. 333,382	2/1993	Cheng	D6/634
D. 350,867	9/1994	Lim	D6/631
D. 375,015	10/1996	Kobayashi et al.	D6/632
D. 385,145	10/1997	Verweyst et al.	D6/632

Primary Examiner—Louis S. Zarfes

Assistant Examiner—Catherine R. Oliver

Attorney, Agent, or Firm—Herbert L. Lerner; Laurence A. Greenberg

[57] **CLAIM**

The ornamental design for a combined digital disk pack and insert, as shown and described.

DESCRIPTION

FIG. 1 is a top plan view of the combined digital disk pack and insert showing my new design;
 FIG. 2 is a bottom plan view thereof;
 FIG. 3 is a right side-elevation view thereof;
 FIG. 4 is a left side-elevation view thereof;
 FIG. 5 is a front elevation view thereof showing an insert fitted inside of the pack;
 FIG. 6 is a rear elevation view thereof;
 FIG. 7 is a perspective view thereof;
 FIG. 8 is a perspective view of the insert which fits inside of the pack;
 FIG. 9 is a sectional view taken along the lines 9—9 in FIG. 8;
 FIG. 10 is a top plan view of the insert;
 FIG. 11 is a right side-elevation view thereof, it being understood that the left side-elevation view is a mirror image; and,
 FIG. 12 is front elevational view thereof, it being understood that the rear elevational view is a mirror image.

1 Claim, 5 Drawing Sheets

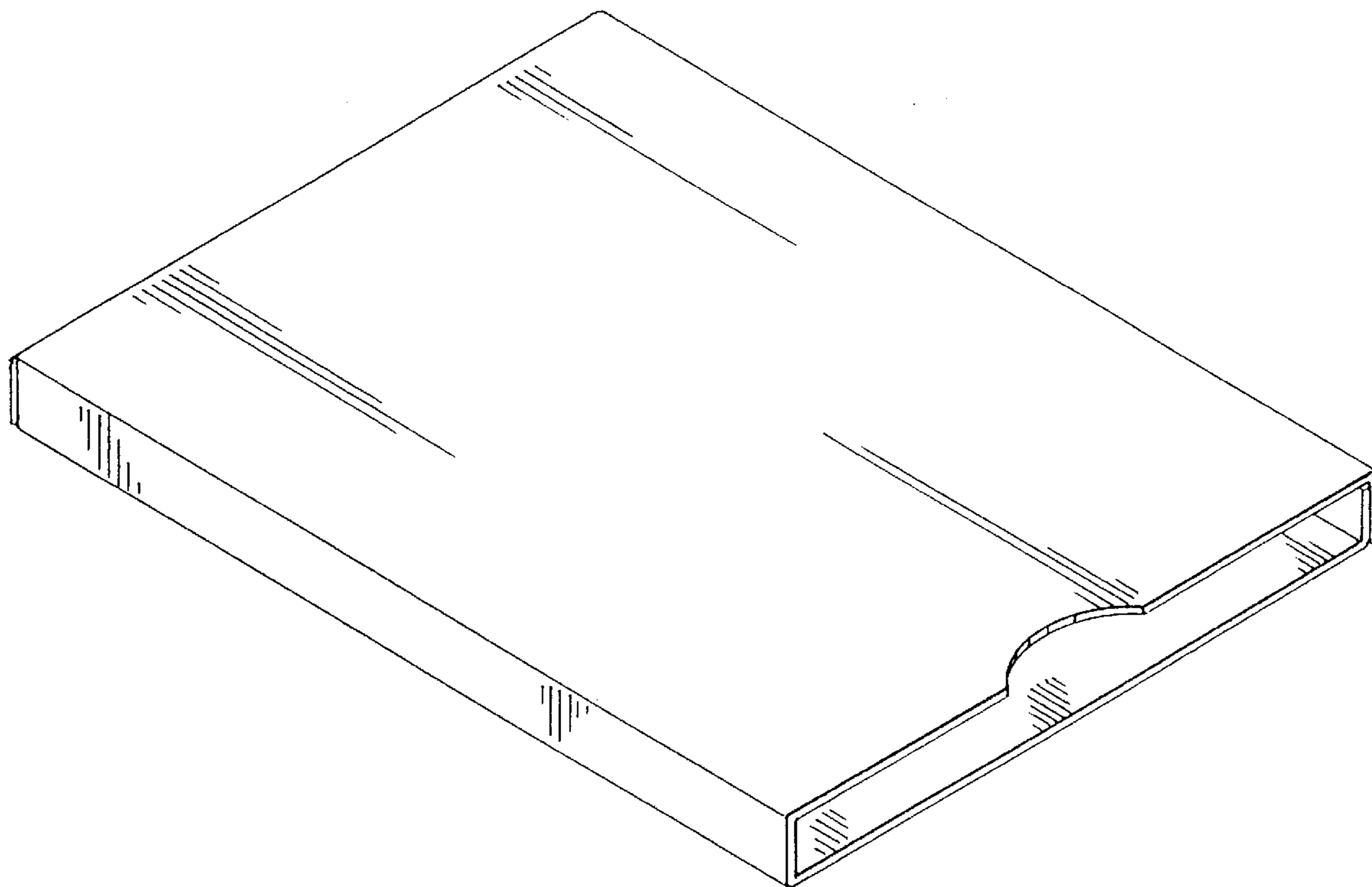

Fig. 1

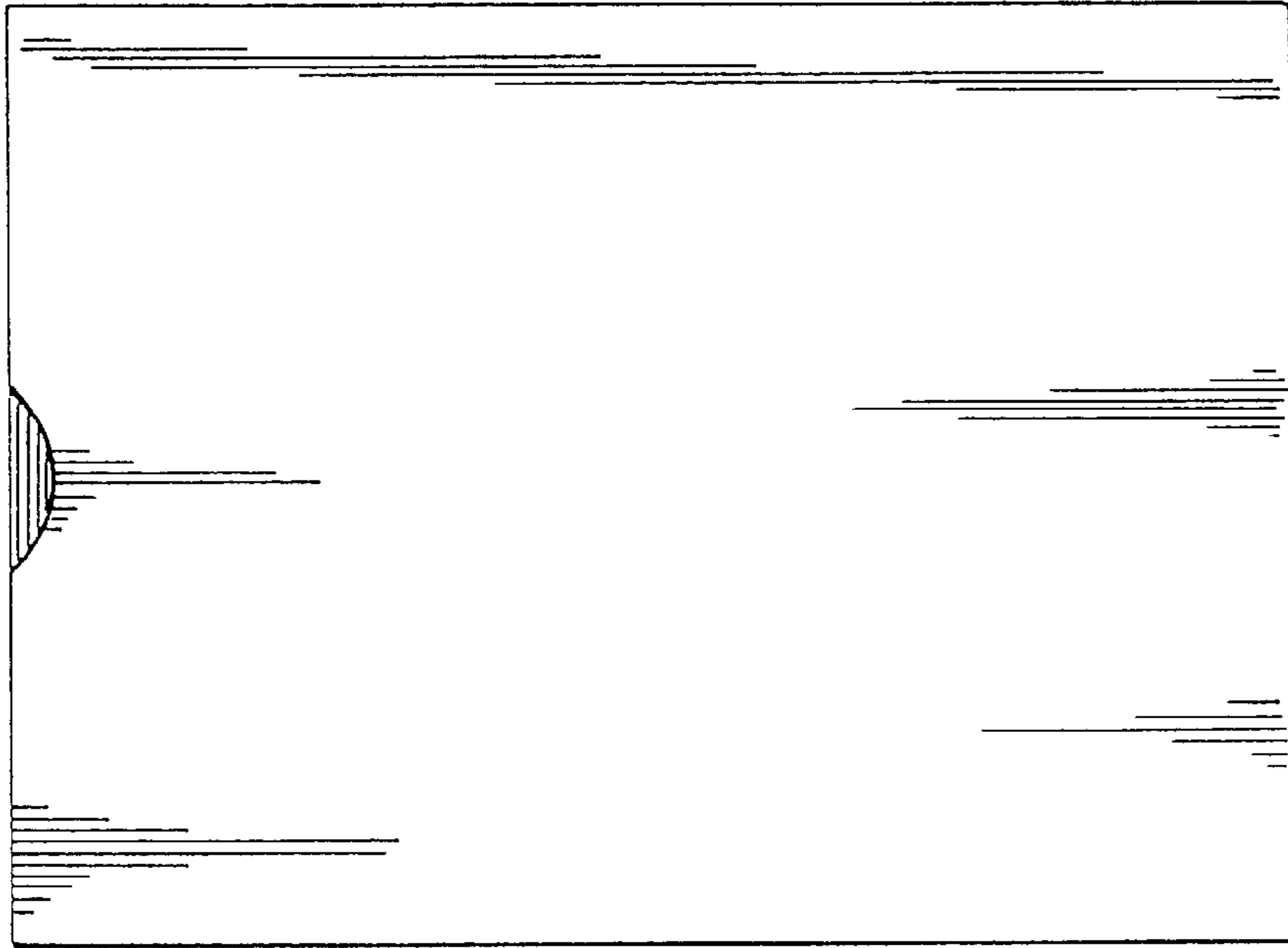
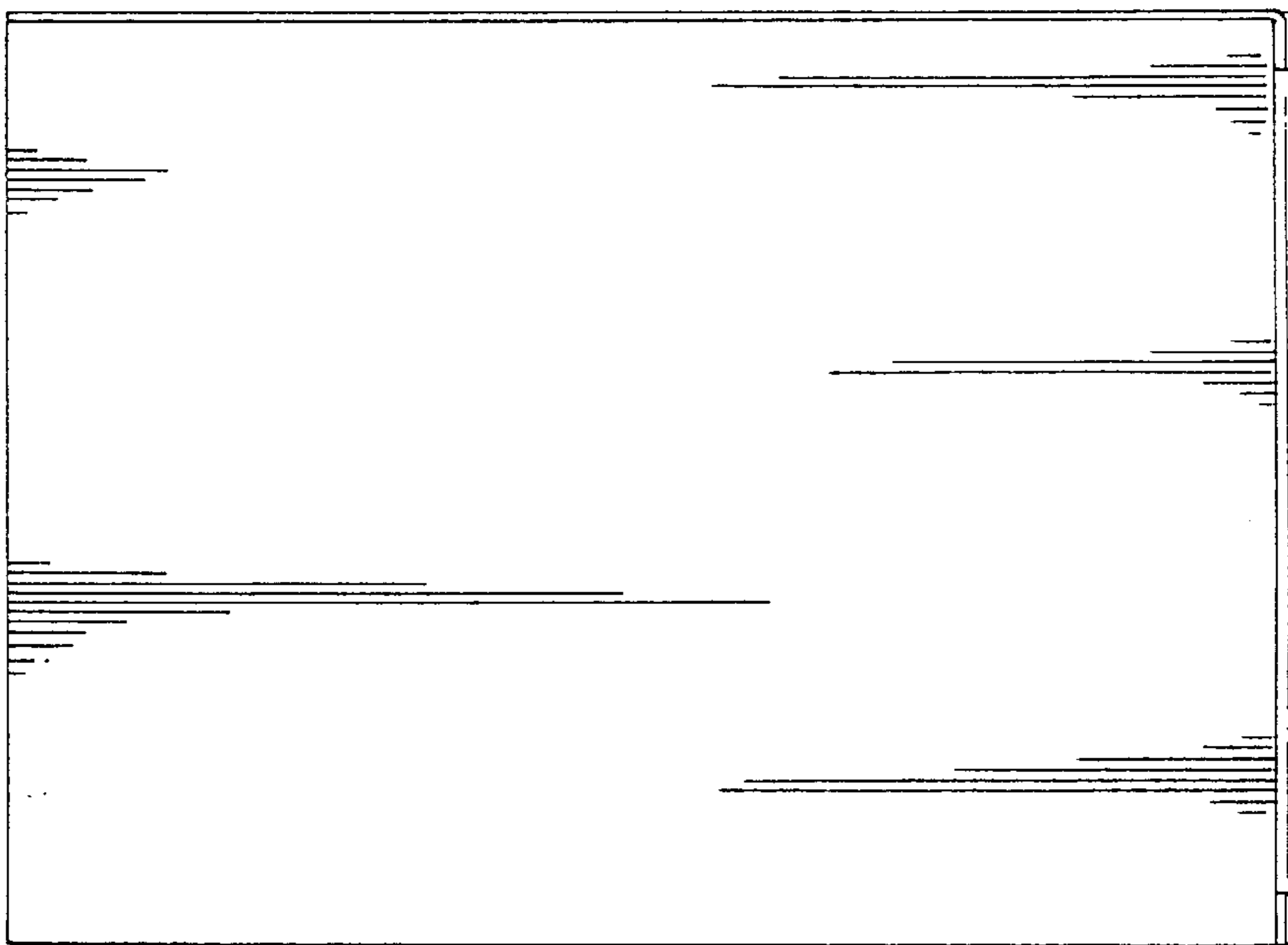

Fig. 2



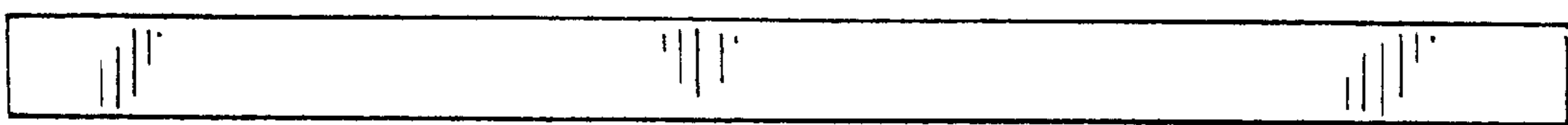

Fig. 3

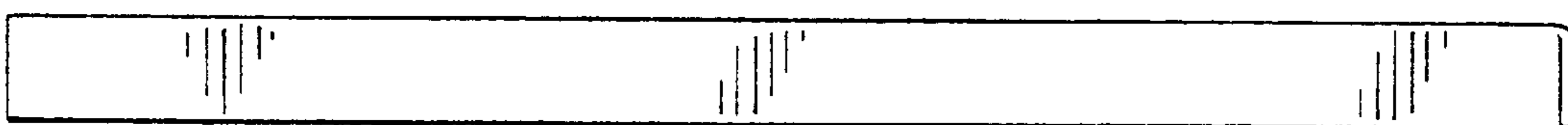

Fig. 4

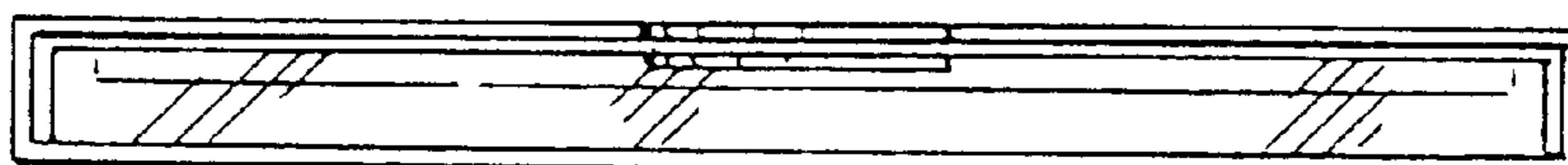

Fig. 5

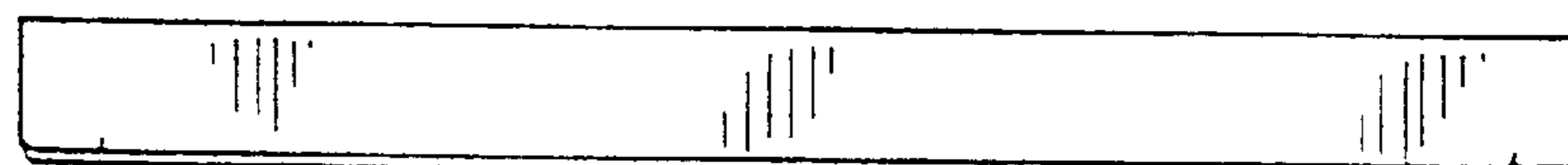

Fig. 6

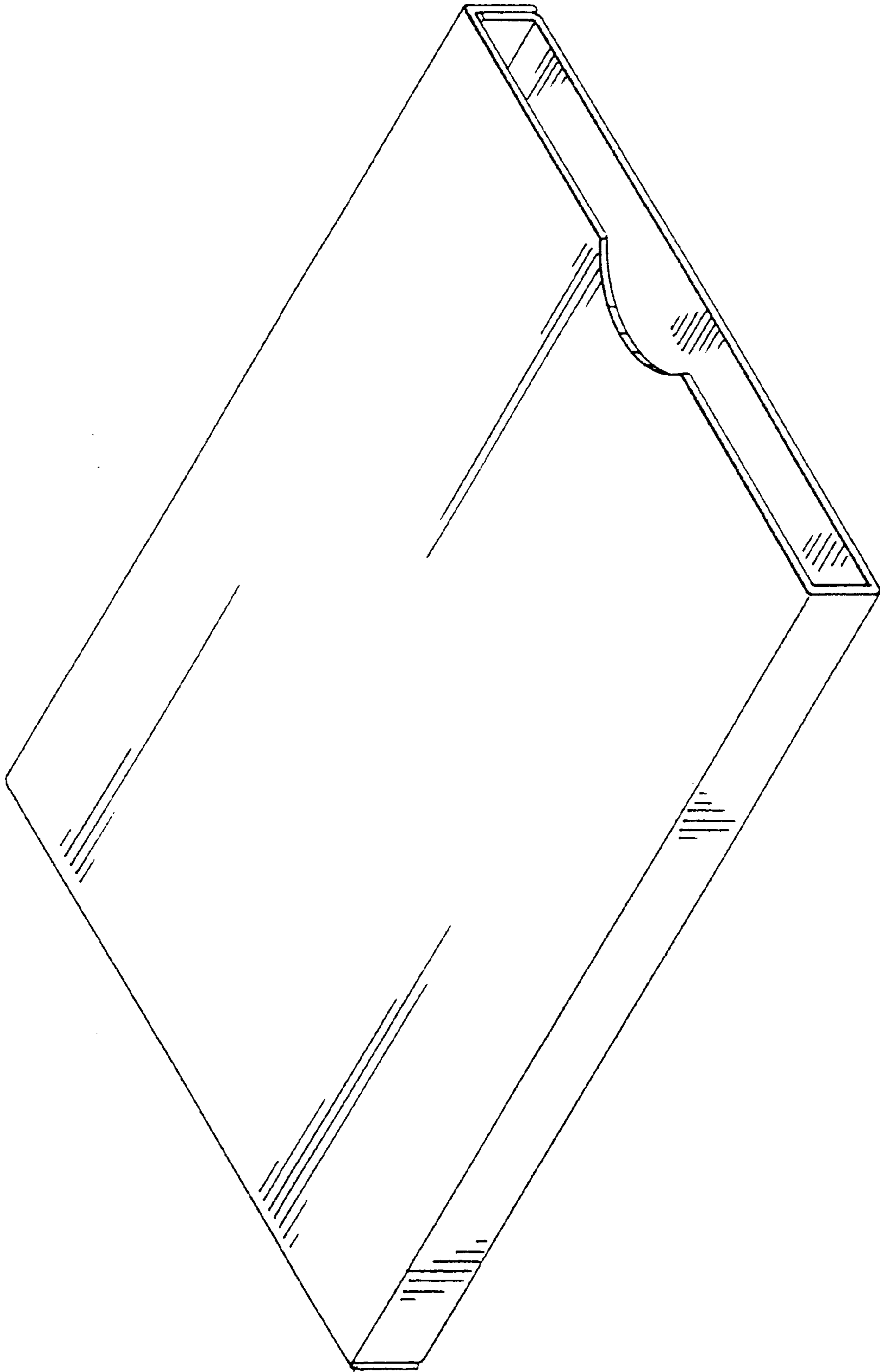

Fig. 7

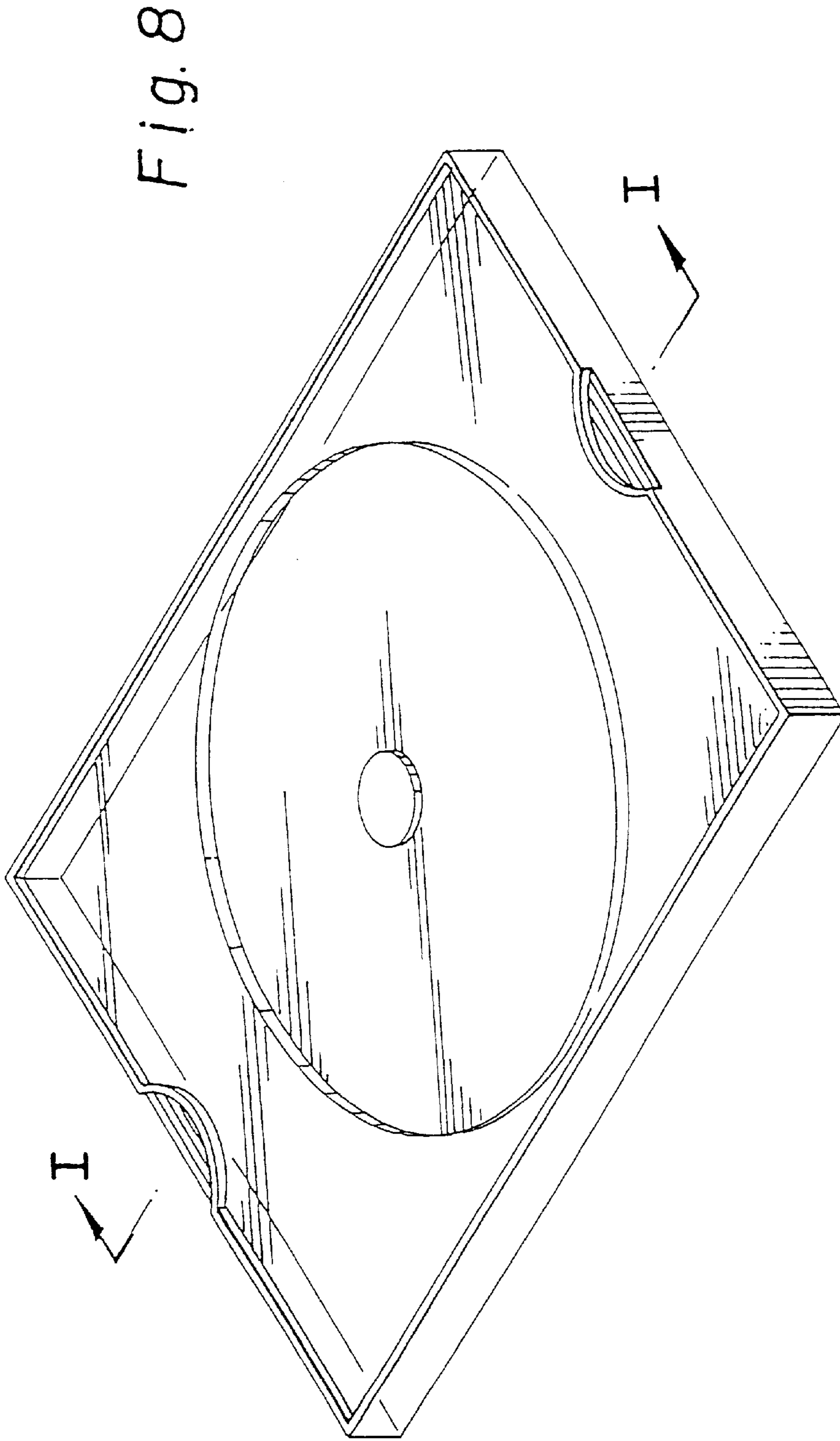
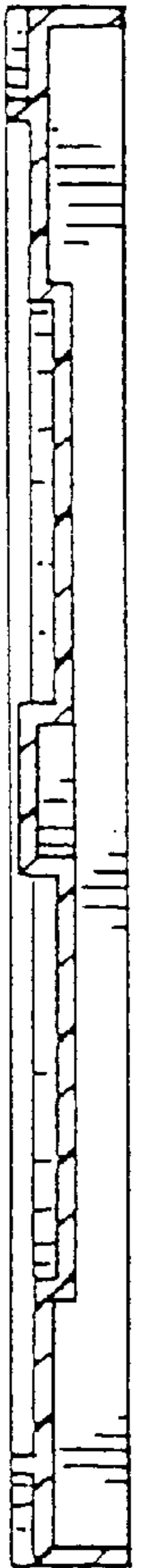

Fig. 9



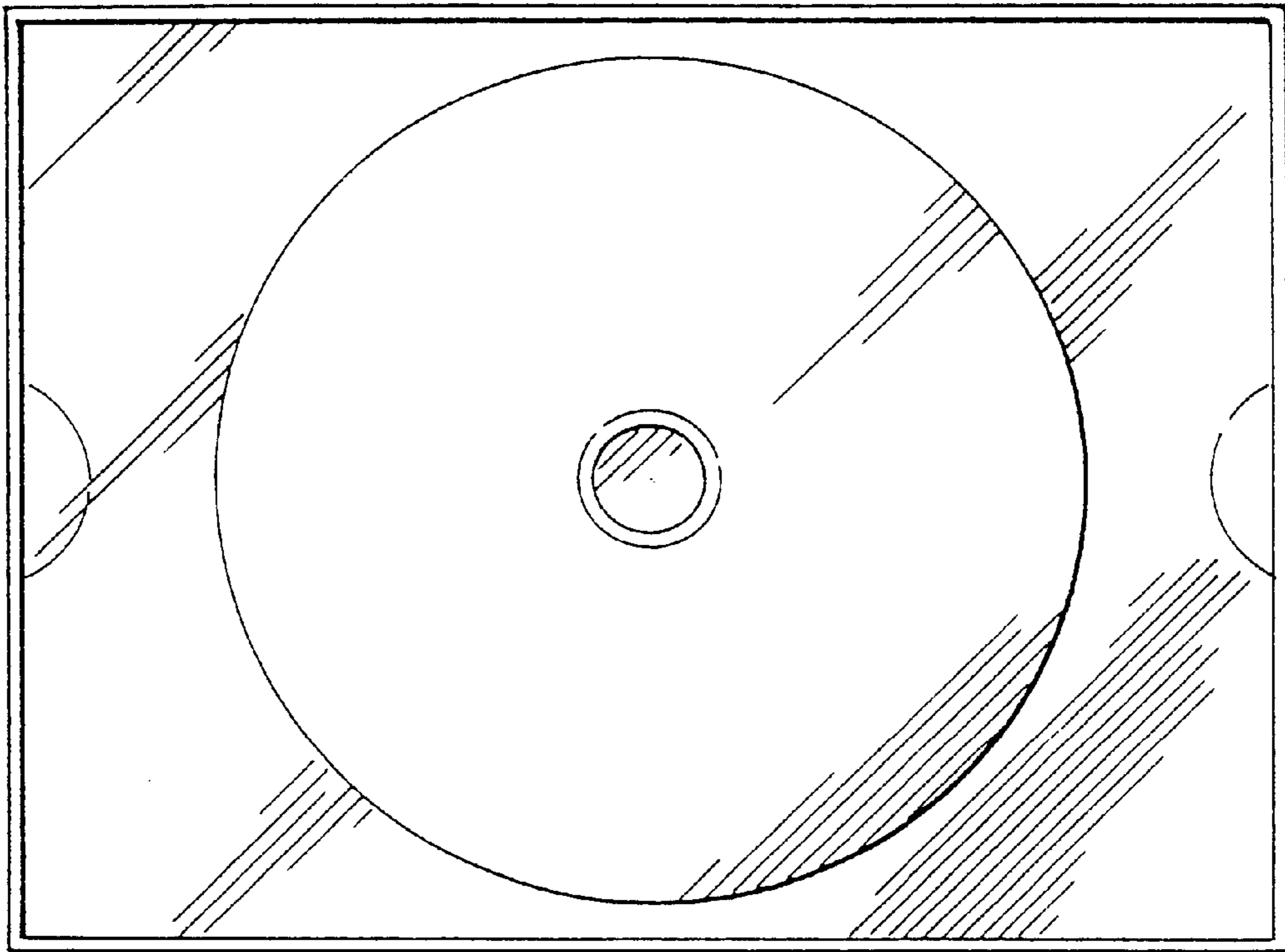

Fig. 10

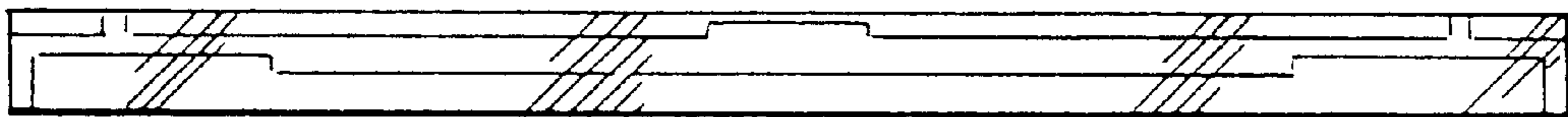

Fig. 11

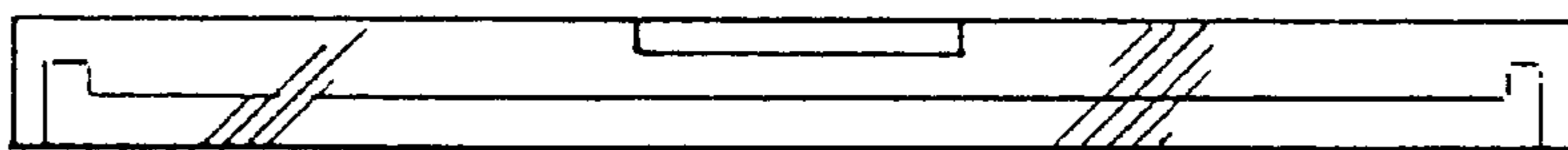

Fig. 12