



US00D417800S

United States Patent [19] Draper

[11] **Patent Number: Des. 417,800**

[45] **Date of Patent: ** Dec. 21, 1999**

[54] **STORAGE UNIT**

D. 378,716 4/1997 Mann et al. D6/446 X

[76] Inventor: **William P. Draper**, 1803 N. Fifth St.,
Perkasie, Pa. 18944

Primary Examiner—Carmen H Vales-Lado
Attorney, Agent, or Firm—Grimes & Battersby

[**] Term: **14 Years**

[57] CLAIM

[21] Appl. No.: **29/086,170**

The ornamental design for a storage unit, as shown and described.

[22] Filed: **Apr. 7, 1998**

DESCRIPTION

[51] **LOC (6) Cl.** **06-04**

FIG. 1 is a perspective view of a storage unit showing my new desing;

[52] **U.S. Cl.** **D6/445**

FIG. 2 is a front elevational view thereof;

[58] **Field of Search** D6/432-448; 312/204

FIG. 3 is a top plan view thereof;

[56] References Cited

FIG. 4 is a left side elevational view as seen when in use;

U.S. PATENT DOCUMENTS

- D. 178,519 8/1956 Jakobsen D6/445
- D. 271,643 12/1983 Thompson D6/446
- D. 326,194 5/1992 Lewis D6/446
- D. 374,134 10/1996 Reese D6/446 X

FIG. 5 is a right side elevational view as seen when in use;

FIG. 6 is a rear elevational view thereof;

FIG. 7 is a bottom view thereof; and,

FIG. 8 is a sectional view taken along line 8—8 of FIG. 2.

1 Claim, 5 Drawing Sheets

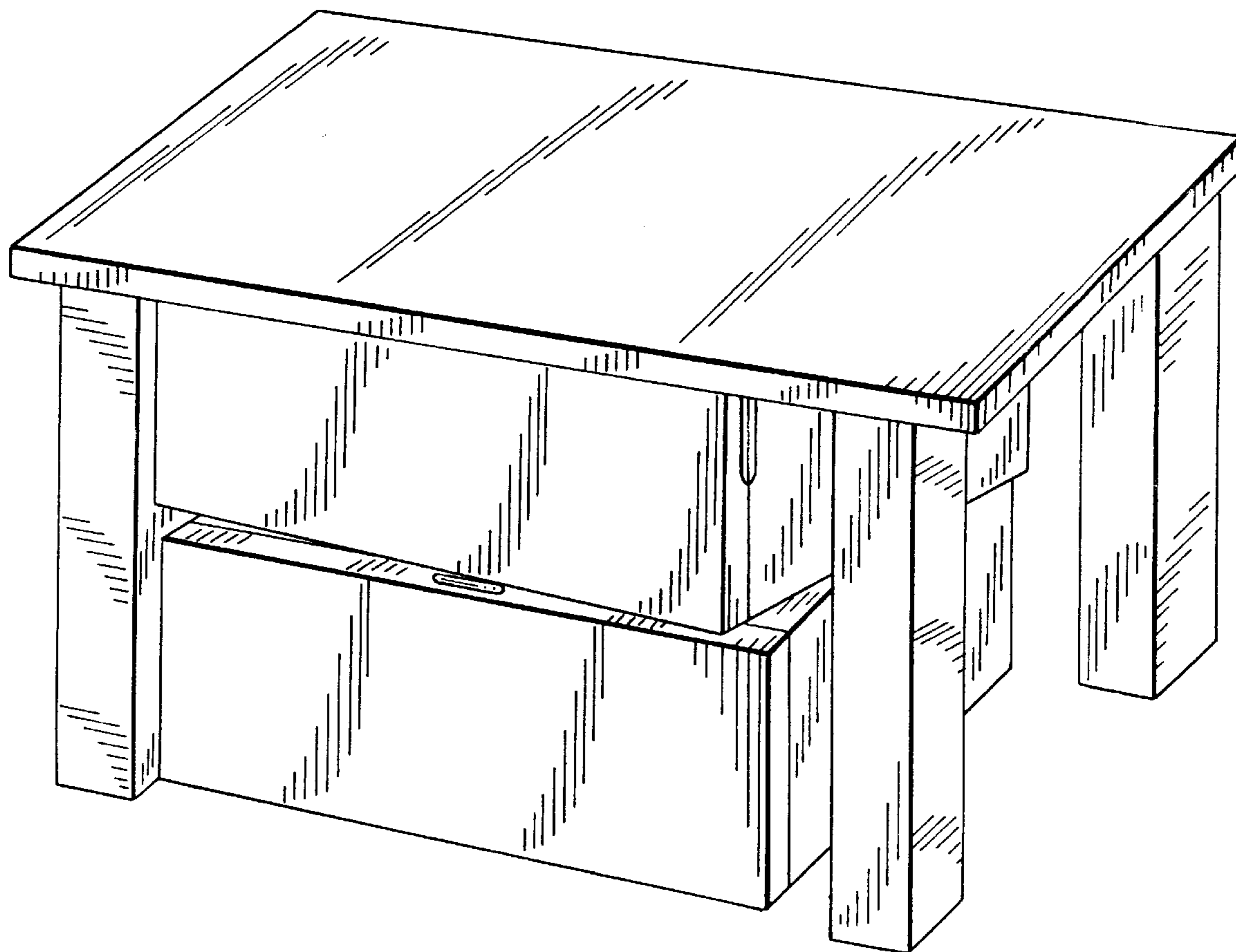

FIG. 1

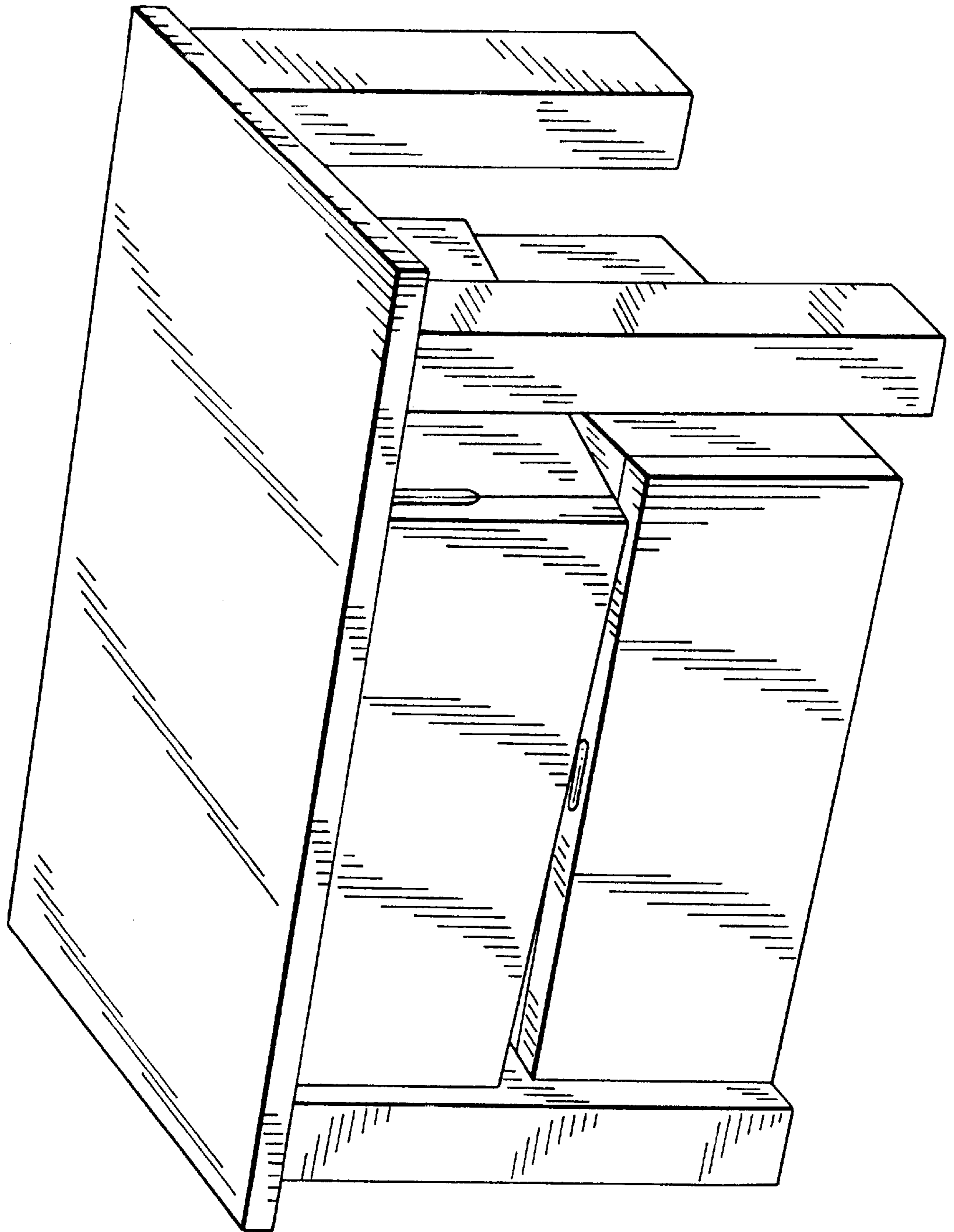

FIG. 2

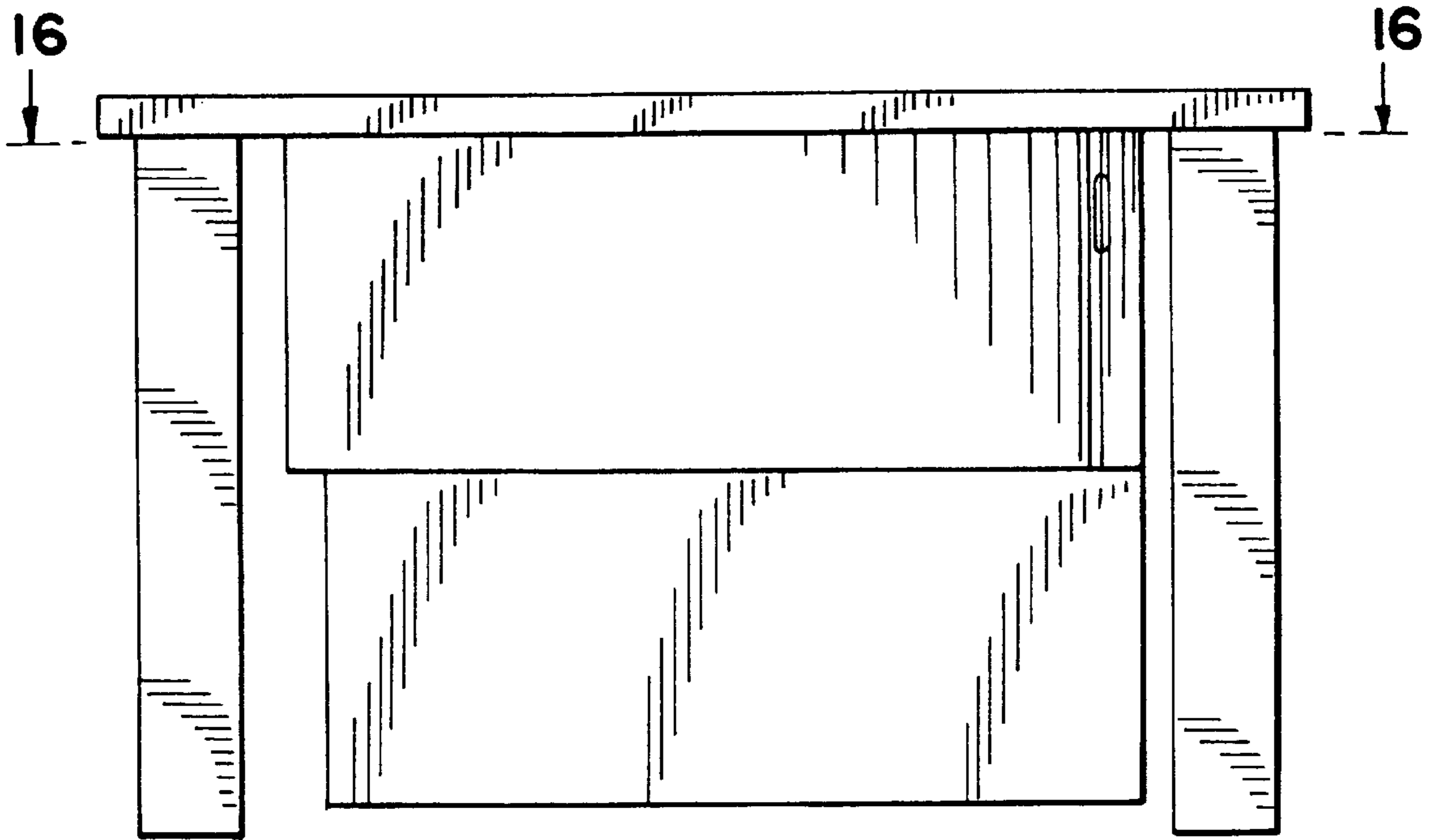
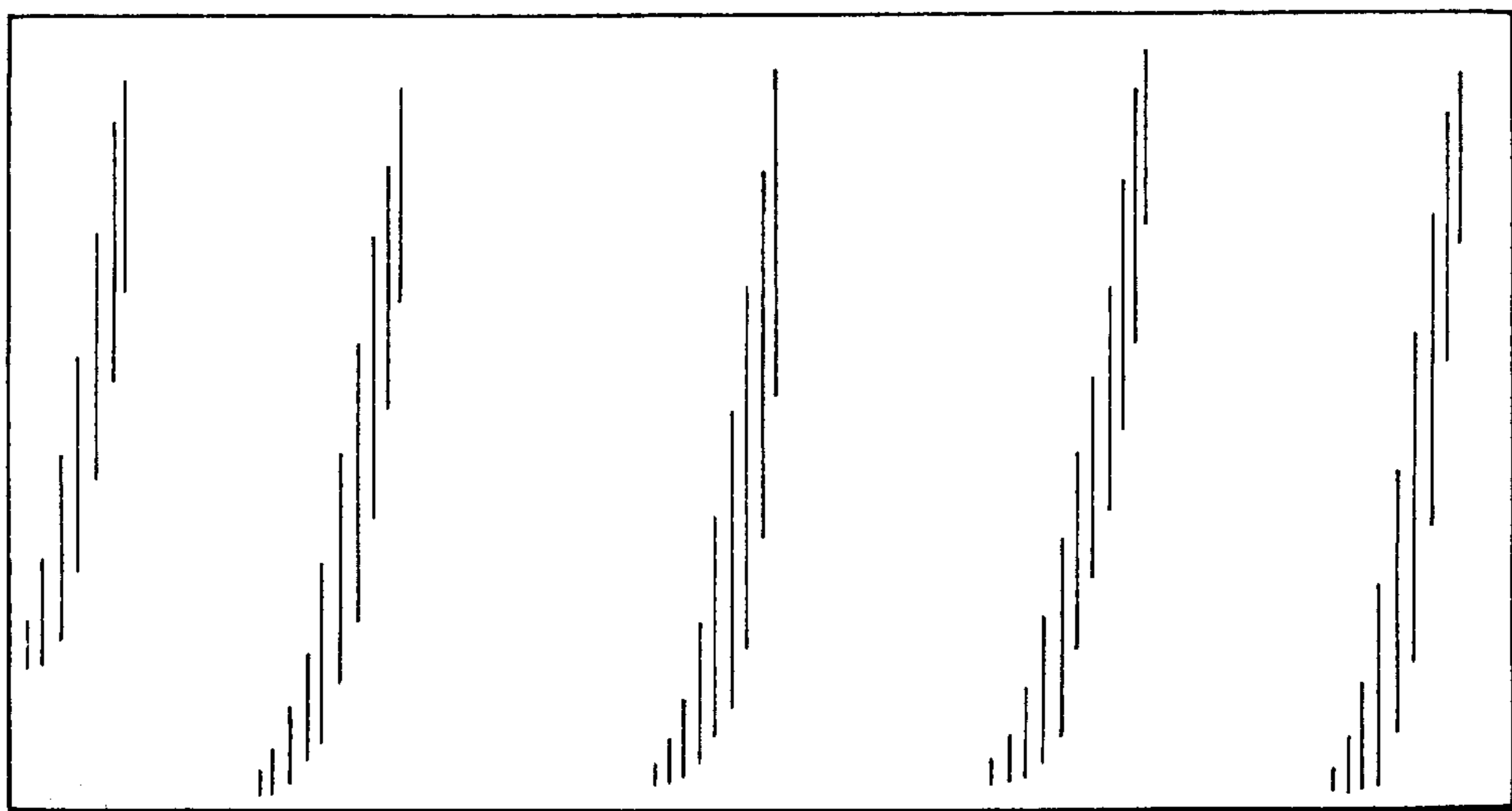

FIG. 3



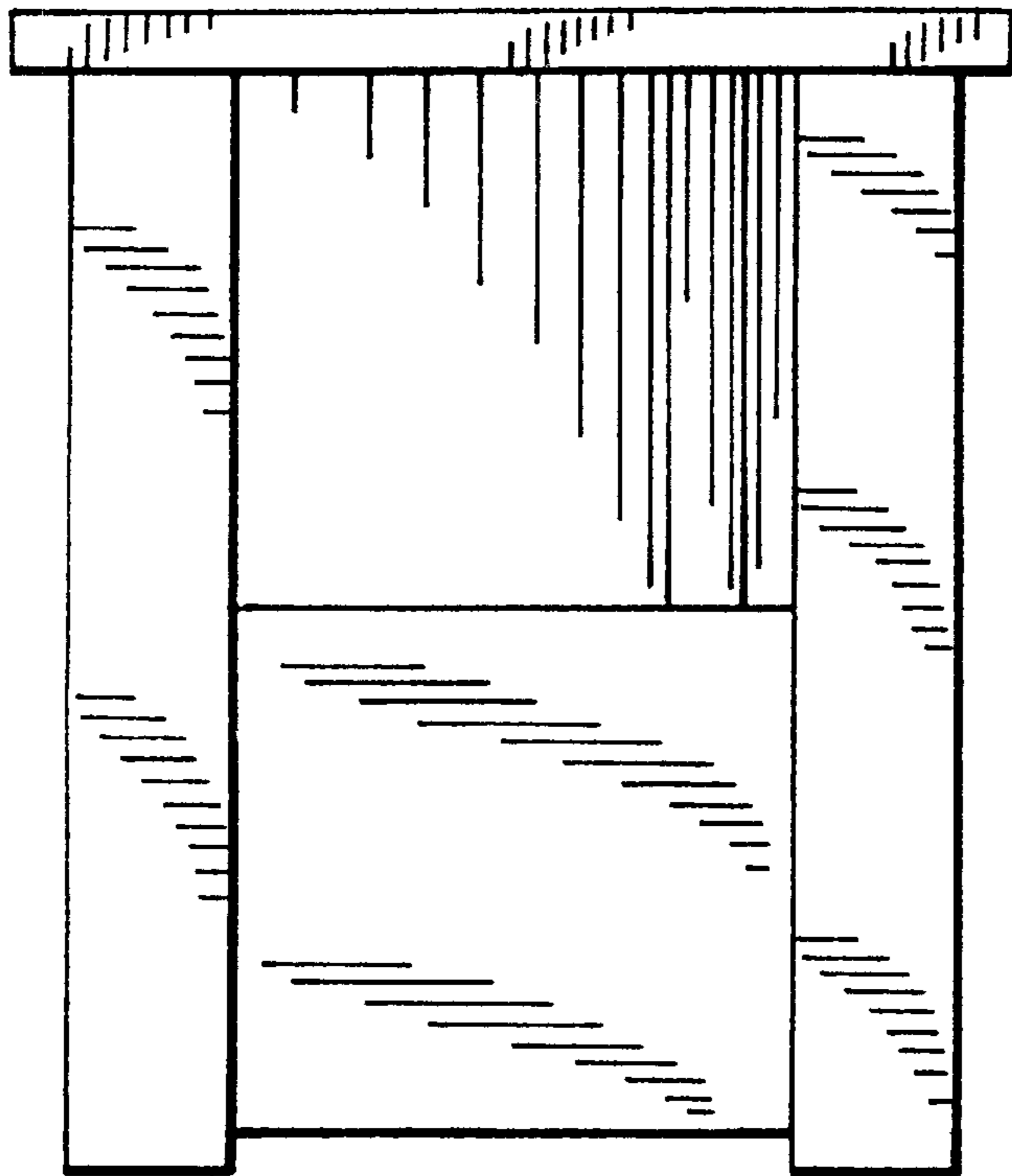

FIG. 4

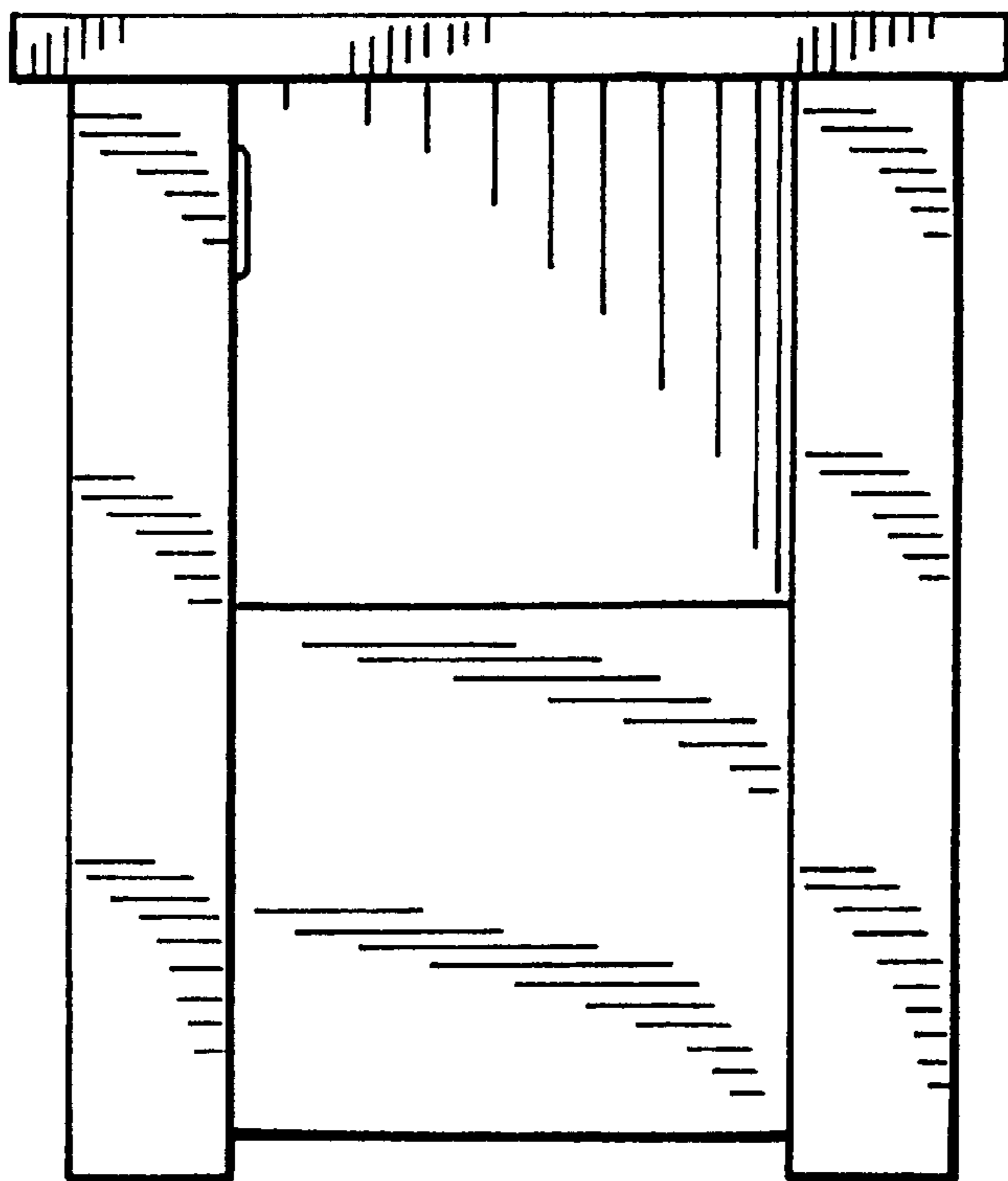

FIG. 5

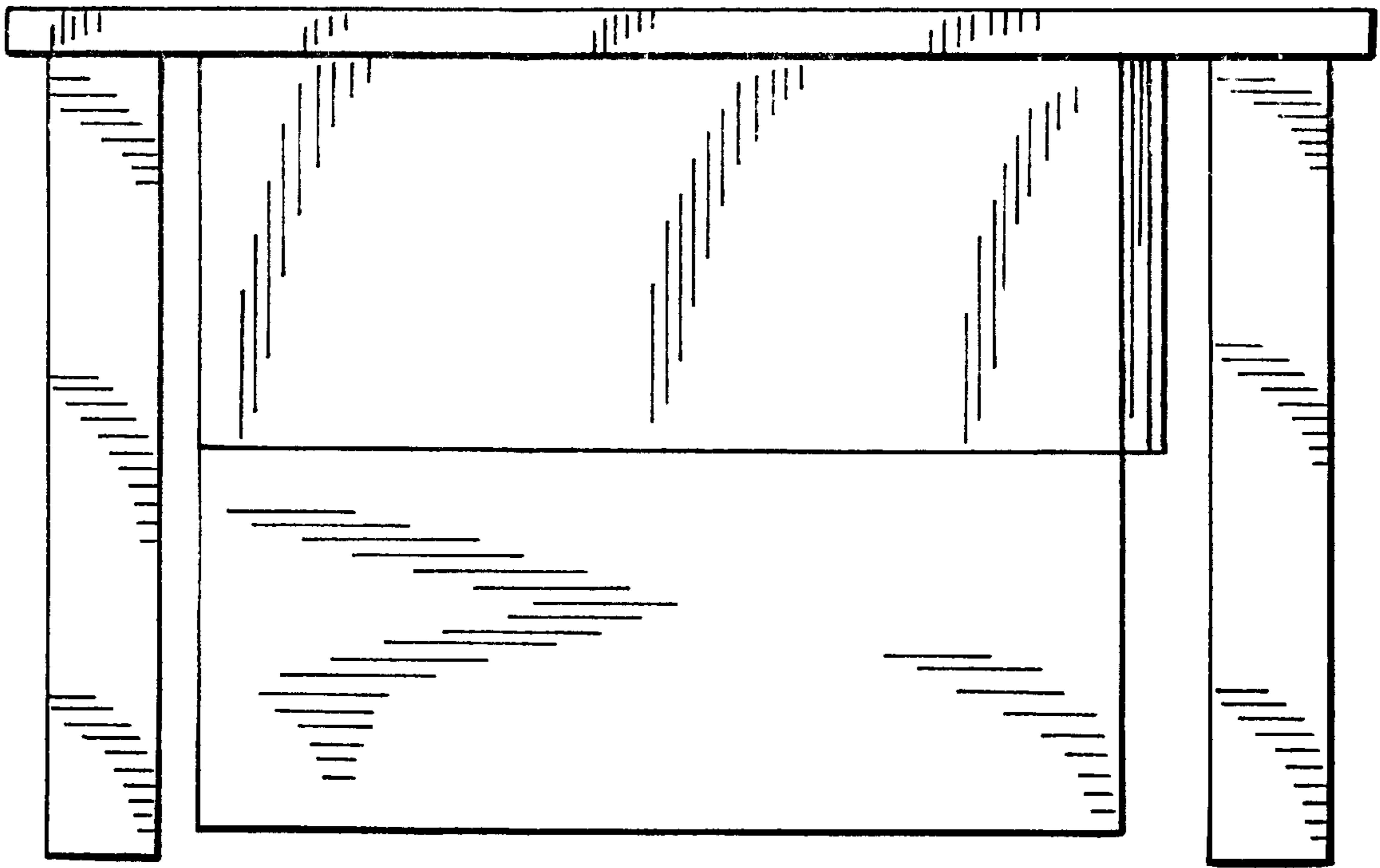

FIG. 6

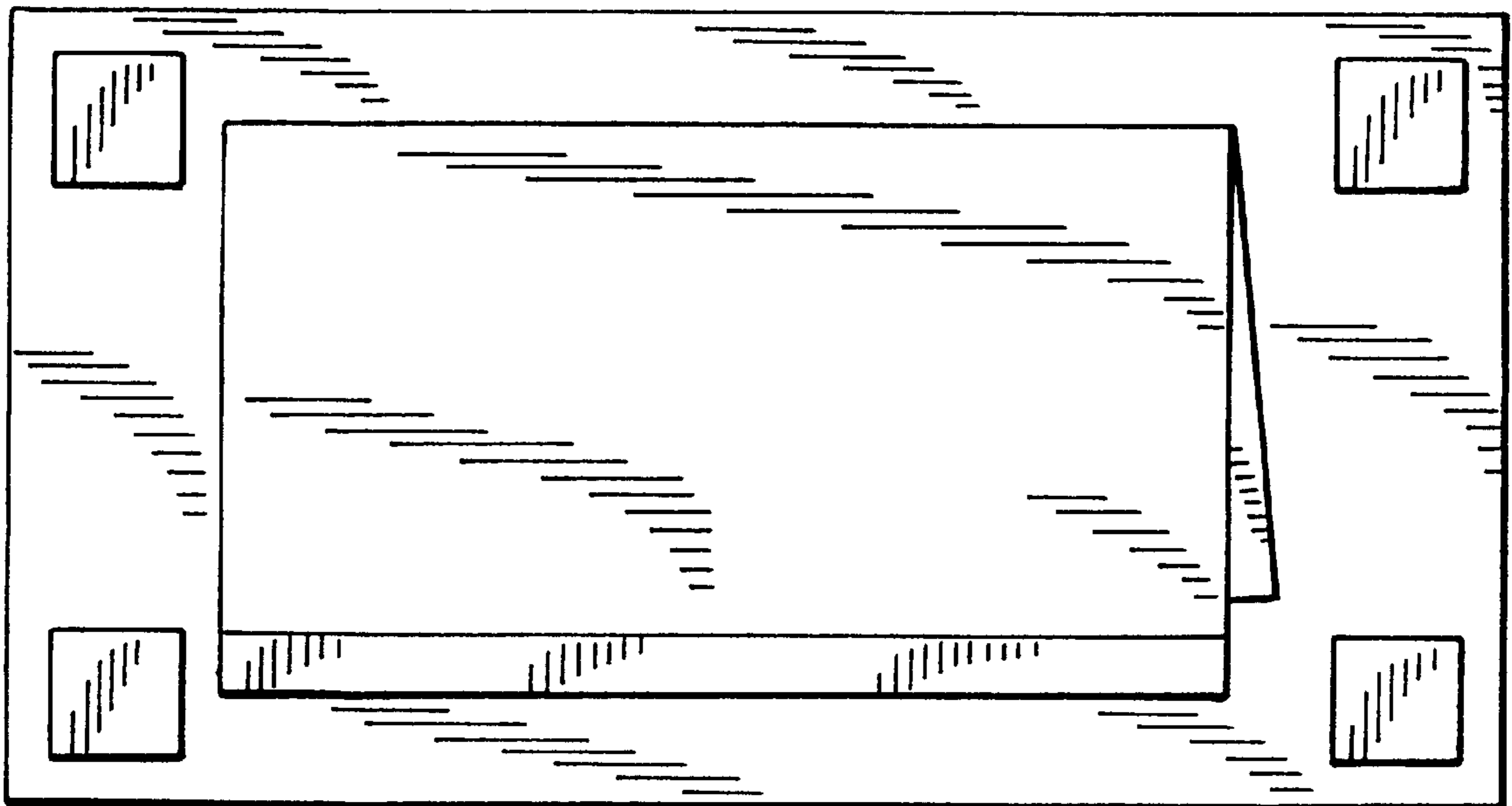

FIG. 7

FIG. 8

