



US00D417778S

**United States Patent** [19]  
**Karlin, III**

[11] **Patent Number: Des. 417,778**

[45] **Date of Patent: \*\* Dec. 21, 1999**

[54] **BABY BOTTLE HOLDER**

5,873,551 2/1999 Jones ..... 248/102

[76] Inventor: **Philip Karlin, III**, P.O. Box 1005,  
Mattituck, N.Y. 11952

*Primary Examiner*—Louis S. Zarfes  
*Assistant Examiner*—Catherine R. Oliver  
*Attorney, Agent, or Firm*—Goldstein & Canino

[\*\*] Term: **14 Years**

[57] **CLAIM**

[21] Appl. No.: **29/102,772**

The ornamental design for a baby bottle holder, as shown and described.

[22] Filed: **Mar. 31, 1999**

[51] **LOC (6) Cl.** ..... **03-01**

[52] **U.S. Cl.** ..... **D3/229**

[58] **Field of Search** ..... D3/215, 229, 202,  
D3/207-211; D11/7, 8; 224/148.2-148.6,  
620, 623; 248/102, 104; 215/11.1; 294/152

**DESCRIPTION**

[56] **References Cited**

**U.S. PATENT DOCUMENTS**

D. 382,503	8/1997	Kalbach	.....	D11/7
2,644,623	7/1953	White	.....	224/148.5
3,065,944	11/1962	Liebendorfer	.....	248/102
5,397,039	3/1995	Parcelles	.....	224/148.5

FIG. 1 is a perspective view of the baby bottle holder showing my new design, with the bottle shown in broken lines for illustrative purposes only and forming no part of the claimed design;

FIG. 2 is a front elevational view of the baby bottle holder.

FIG. 3 is a rear elevational view thereof.

FIG. 4 is a left side elevational view thereof.

FIG. 5 is a right side elevational view thereof.

FIG. 6 is a top plan view of the baby bottle holder; and

FIG. 7 is a bottom plan view thereof.

**1 Claim, 4 Drawing Sheets**

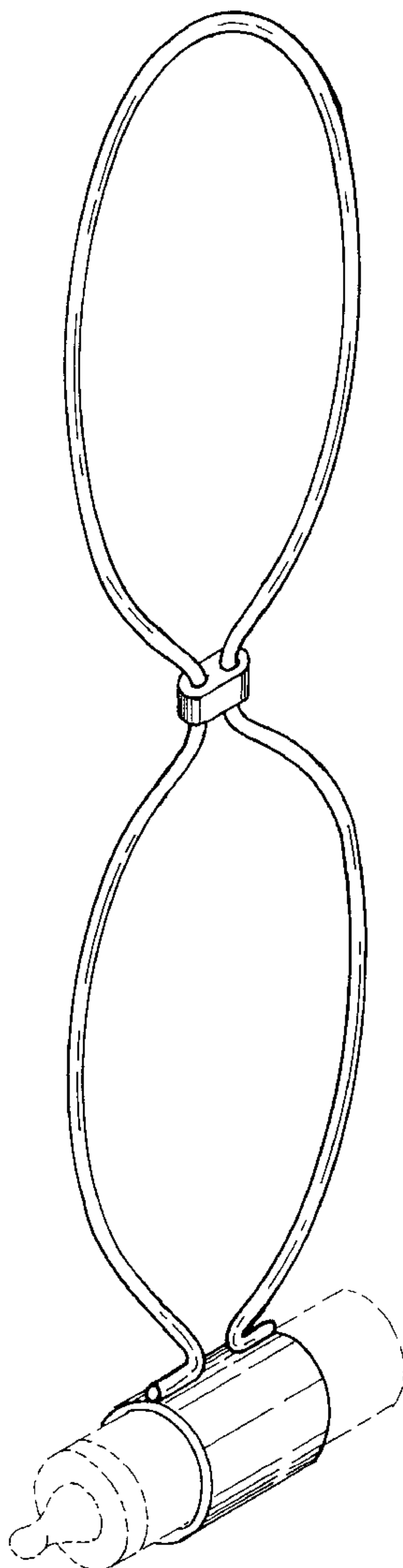

FIG. 1

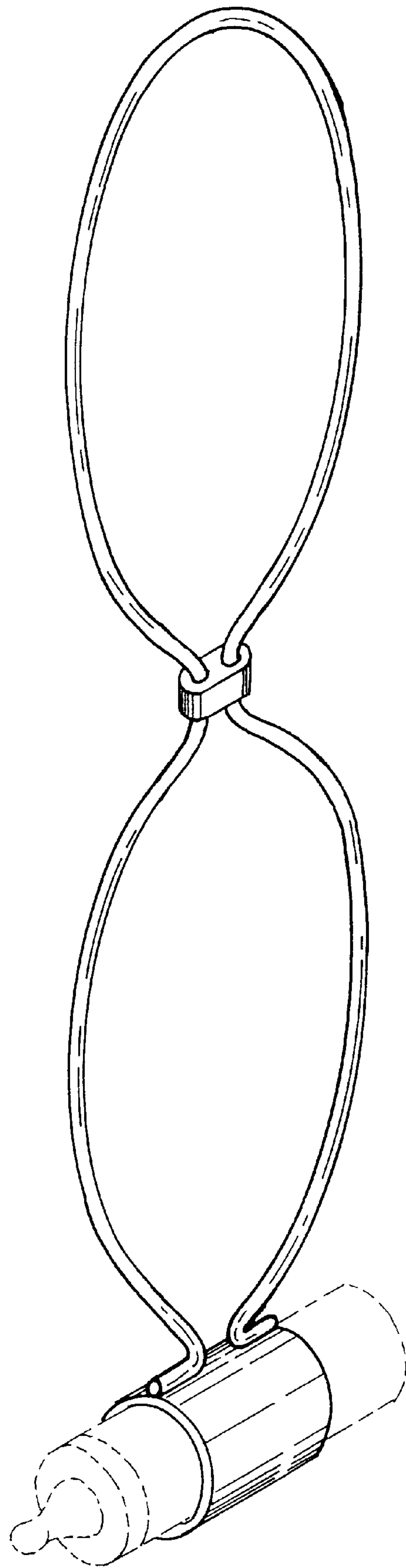

FIG. 2

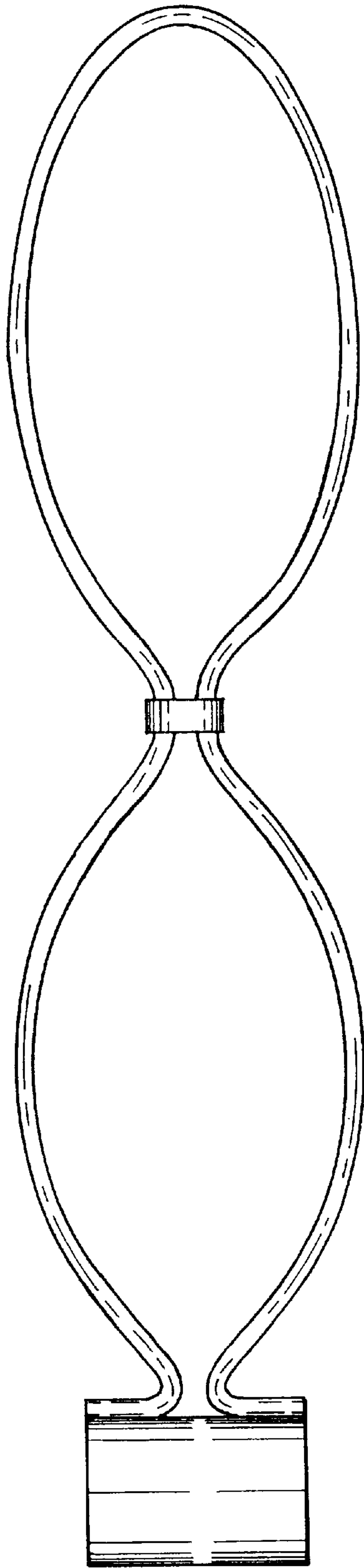

FIG. 3

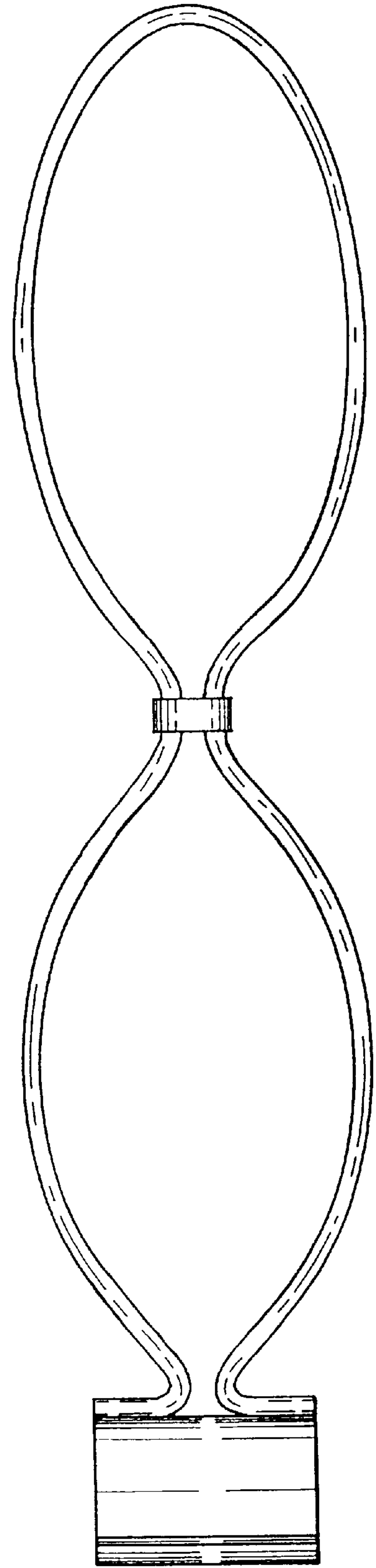

FIG. 4

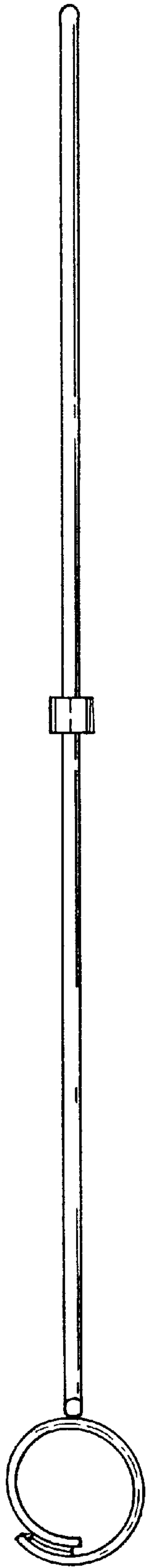

FIG. 5

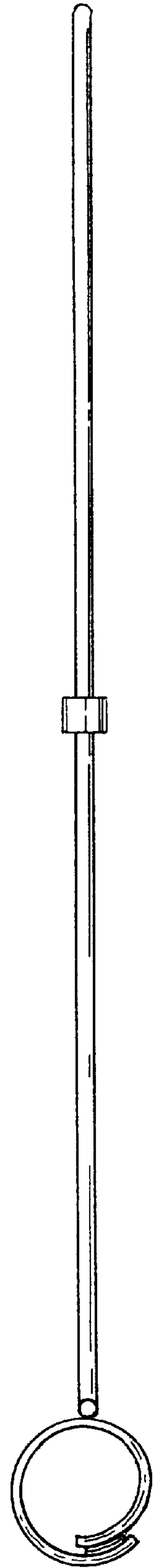

FIG. 6

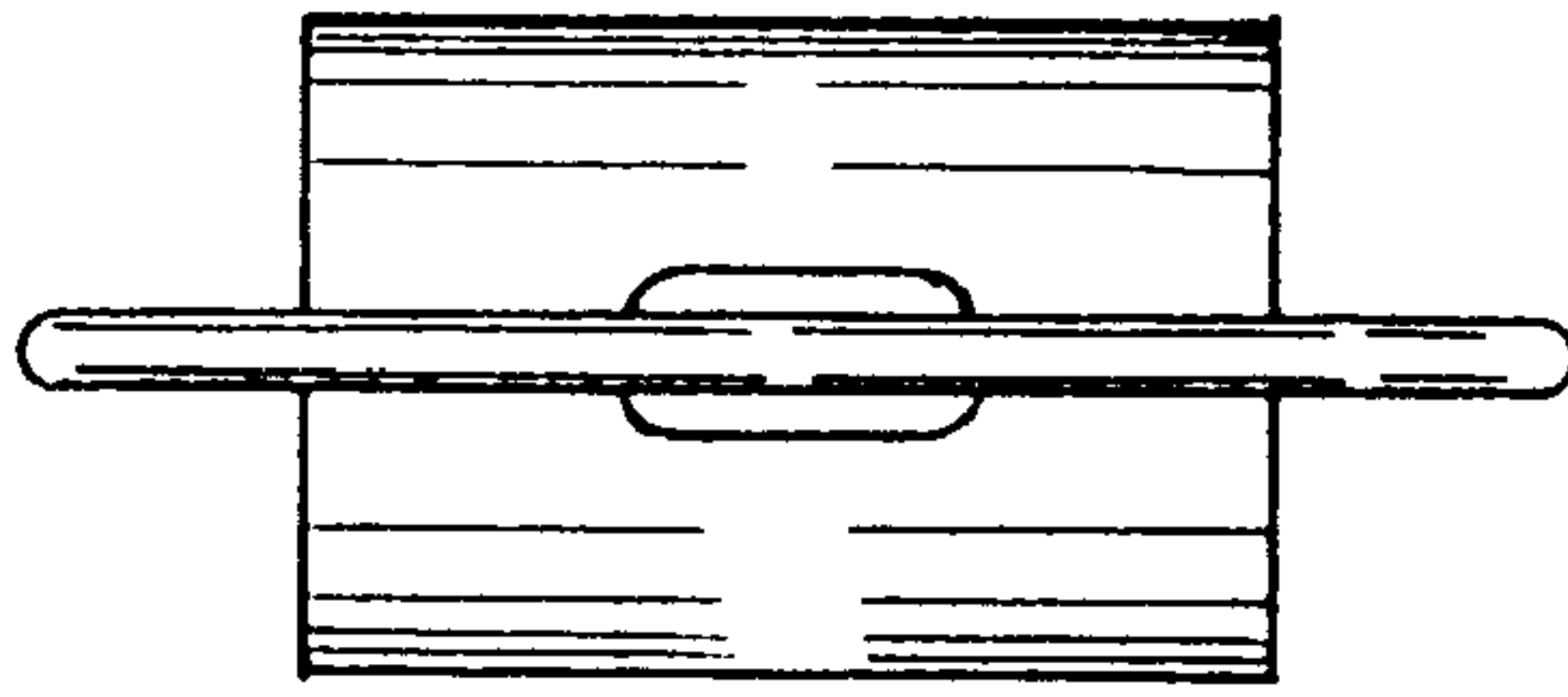

FIG. 7

