



US00D417766S

United States Patent [19]

Sherman et al.

[11] Patent Number: Des. 417,766

[45] Date of Patent: ** Dec. 21, 1999

[54] CHOCOLATE BAR

[75] Inventors: Ryan Sherman; David Ryan, both of Seattle, Wash.

[73] Assignee: Starbucks Corporation, Seattle, Wash.

[**] Term: 14 Years

[21] Appl. No.: 29/099,921

[22] Filed: Jan. 29, 1999

[51] LOC (6) Cl. 01-01

[52] U.S. Cl. D1/127; D1/129

[58] Field of Search D1/127, 128, 199, D1/129, 126, 125, 121, 100; D24/101, 103; D28/8.1; 426/144, 104, 660, 805

[56] **References Cited**

U.S. PATENT DOCUMENTS

D. 21,760	8/1892	Mapother .	
D. 26,312	11/1896	Brown	D1/121
D. 33,706	12/1900	Crosby et al.	D1/121
D. 40,268	9/1909	Marvin .	
D. 40,269	9/1909	Marvin .	
D. 55,542	6/1920	Wipf .	
D. 68,619	11/1925	Epstein	D1/121
D. 70,559	7/1926	Hochstadter .	
D. 88,109	8/1932	Reiche .	
D. 88,226	11/1932	Gold .	
D. 107,317	10/1937	Murguiondo .	
D. 108,546	2/1938	Lazow .	
D. 110,341	7/1938	Carter et al. .	
D. 166,563	1/1952	Peters .	
D. 166,873	5/1952	Peters .	
D. 179,214	11/1956	Peters .	
D. 188,694	8/1960	Freeman .	
D. 194,576	2/1963	Herman .	
D. 195,658	7/1963	Merritt .	
D. 205,572	8/1966	Davies .	
D. 250,556	12/1978	Shorin et al. .	
279,402	6/1883	Lane et al. .	
D. 288,140	2/1987	Fontlladosa .	
D. 315,435	3/1991	Kirkpatrick et al. .	

D. 329,114	9/1992	Kesdekoglu .	
D. 334,645	4/1993	Kennedy .	
D. 338,994	9/1993	Kesdekoglu .	
D. 340,121	10/1993	Russell .	
D. 347,515	6/1994	Creighton et al. .	
D. 357,338	4/1995	Bornhorst .	
D. 372,351	8/1996	Margolis .	
D. 376,038	12/1996	Pearce .	
D. 395,150	6/1998	Yang .	
787,887	4/1905	Baker	D1/127
1,847,062	2/1932	Lemmon, Jr.	426/144
1,850,560	3/1932	Middendorf .	
5,447,584	9/1995	Shakespeare et al. .	

OTHER PUBLICATIONS

Belusa Chocolate, 1987 "#18 Pistachio Candy".

Primary Examiner—Pamela Burgess
Attorney, Agent, or Firm—Christensen O'Connor Johnson & Kindness PLLC

[57] **CLAIM**

We claim the ornamental design for a chocolate bar, as shown and described.

DESCRIPTION

FIG. 1 is a perspective view of our new chocolate bar;
 FIG. 2 is a top view thereof;
 FIG. 3 is a bottom view thereof;
 FIG. 4 is a front side view thereof, the back view being the same;
 FIG. 5 is a right side view thereof, the left side view being the same;
 FIG. 6 is a perspective view of a second embodiment of our new chocolate bar;
 FIG. 7 is a top view thereof;
 FIG. 8 is a bottom view thereof;
 FIG. 9 is a front side view thereof, the back view being the same; and,
 FIG. 10 is a right side view thereof, the left side view being the same.

1 Claim, 2 Drawing Sheets

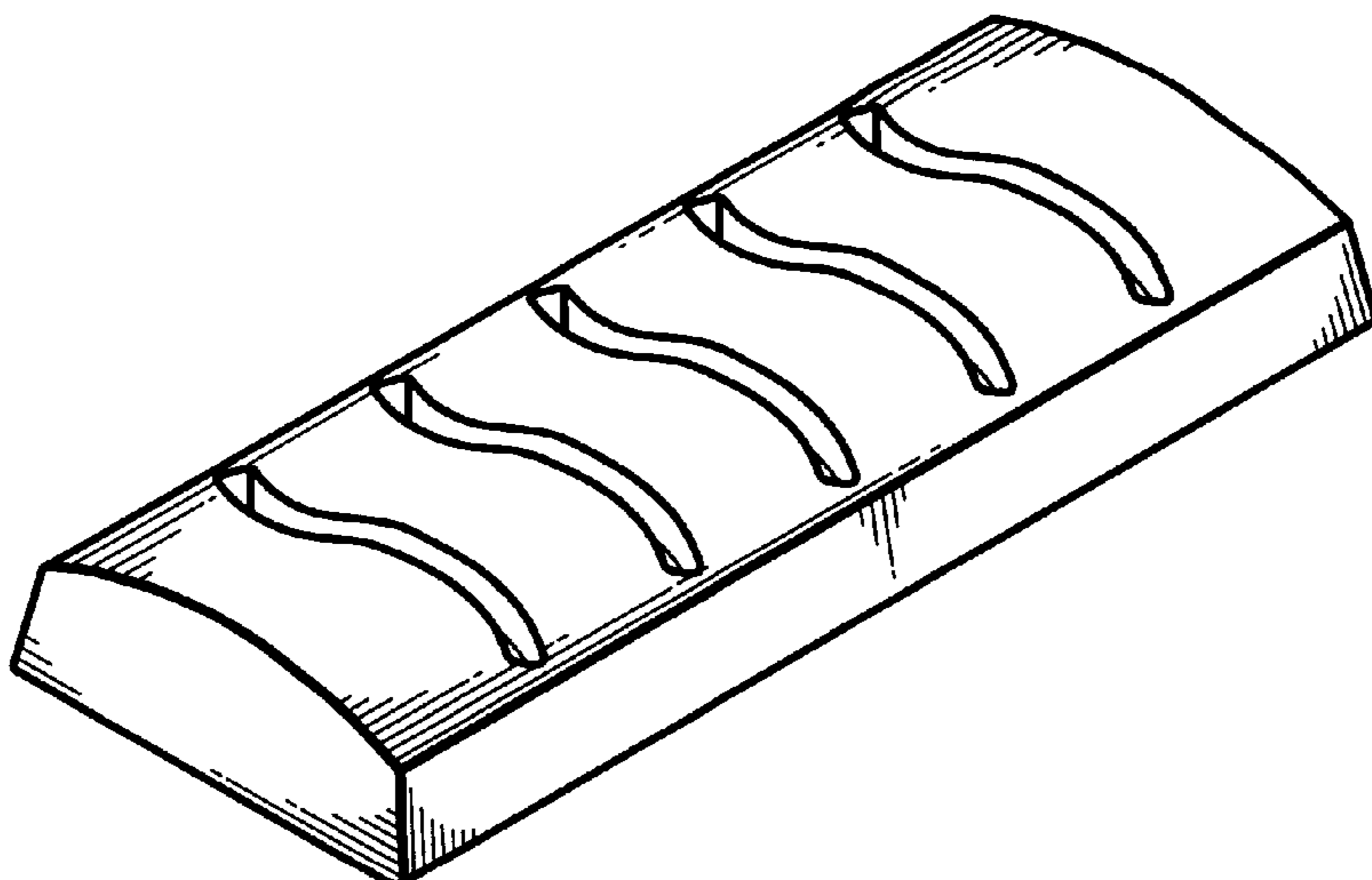

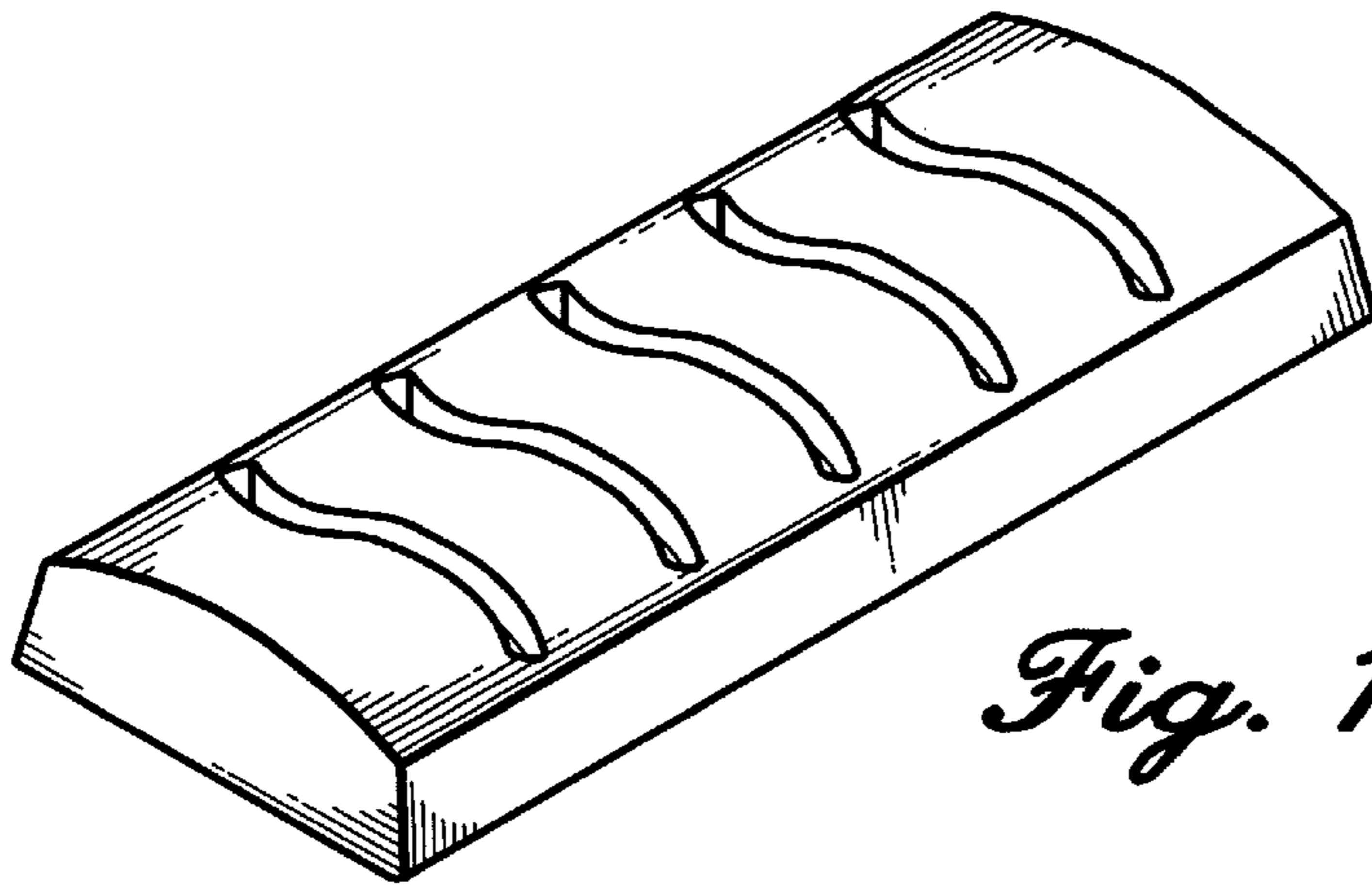

Fig. 1

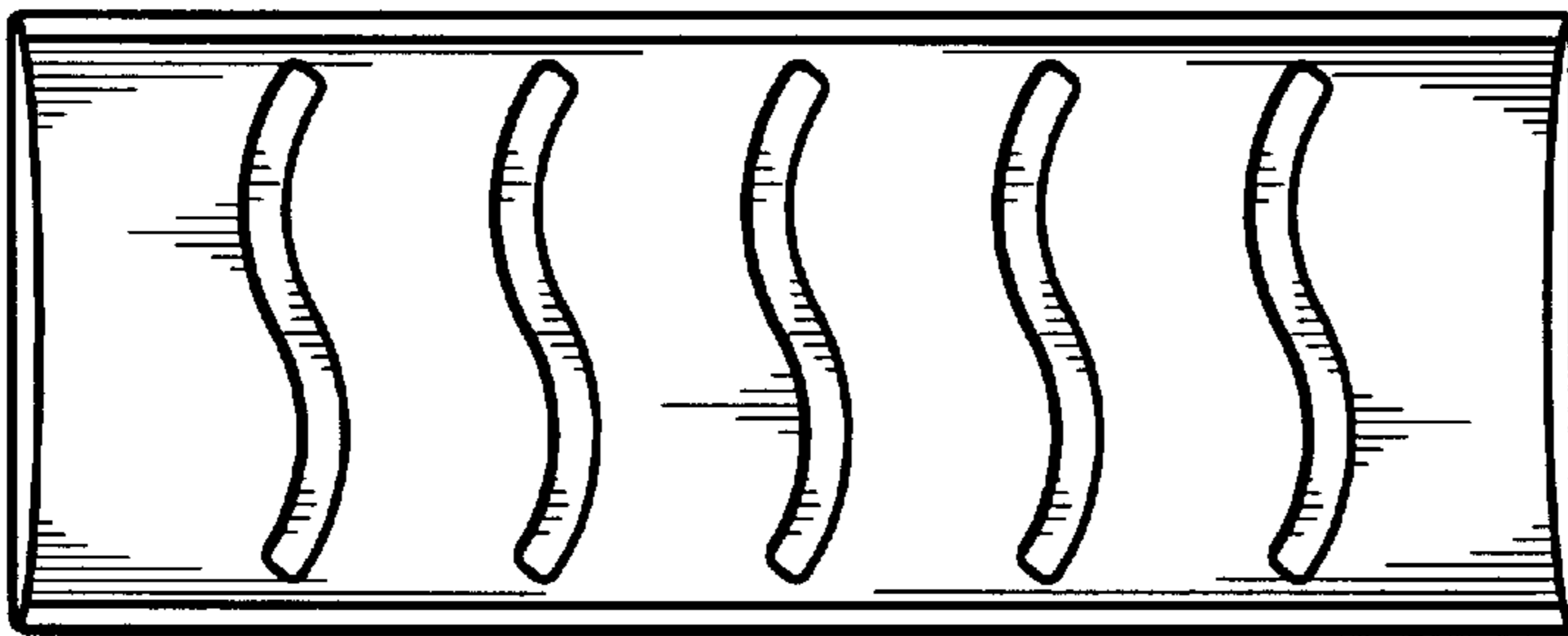

Fig. 2

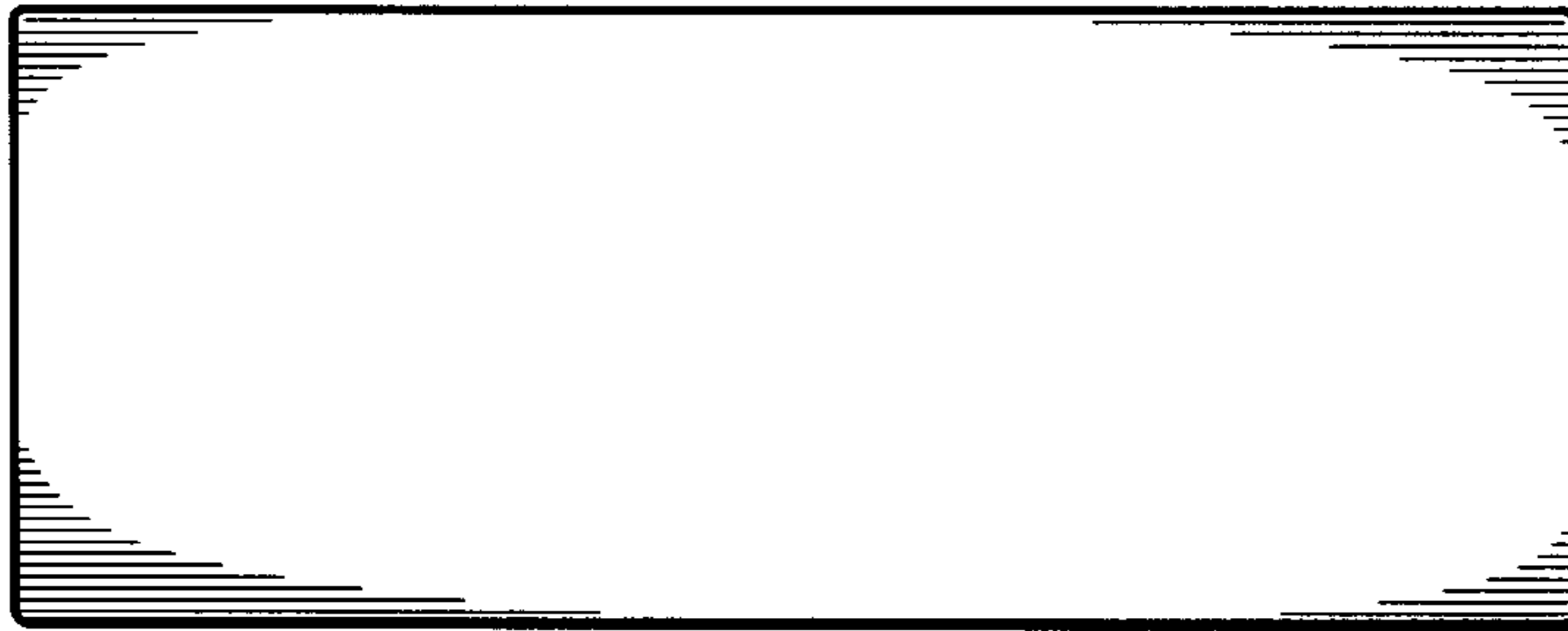

Fig. 3



Fig. 4



Fig. 5

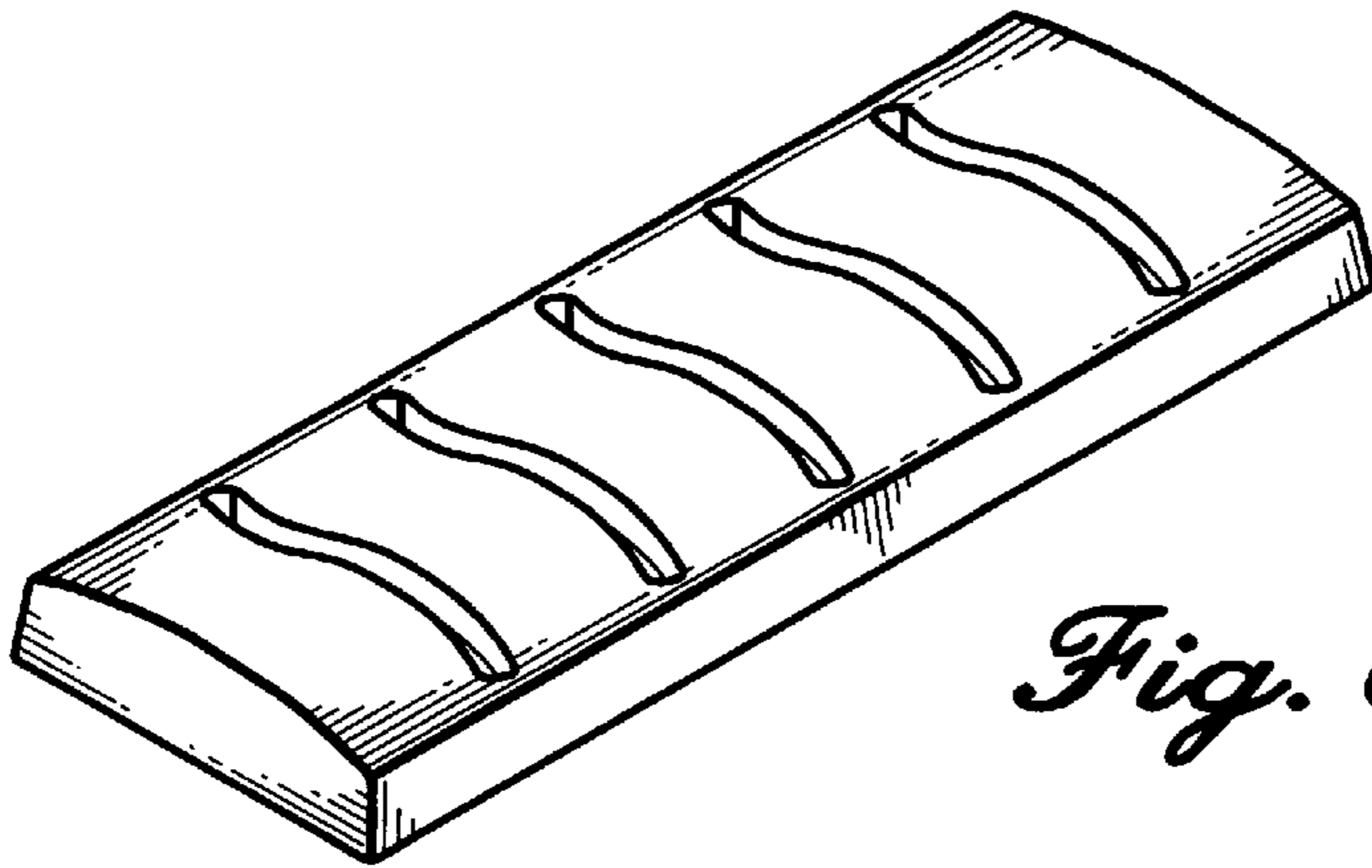

Fig. 6

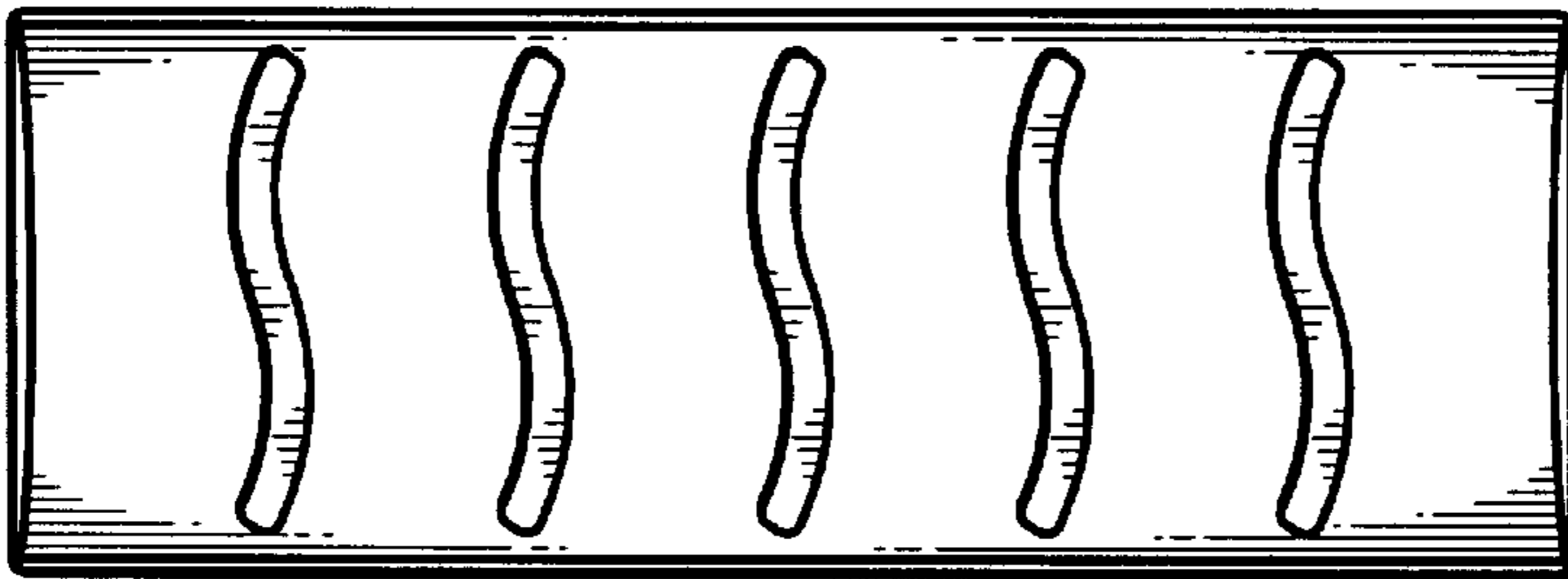

Fig. 7

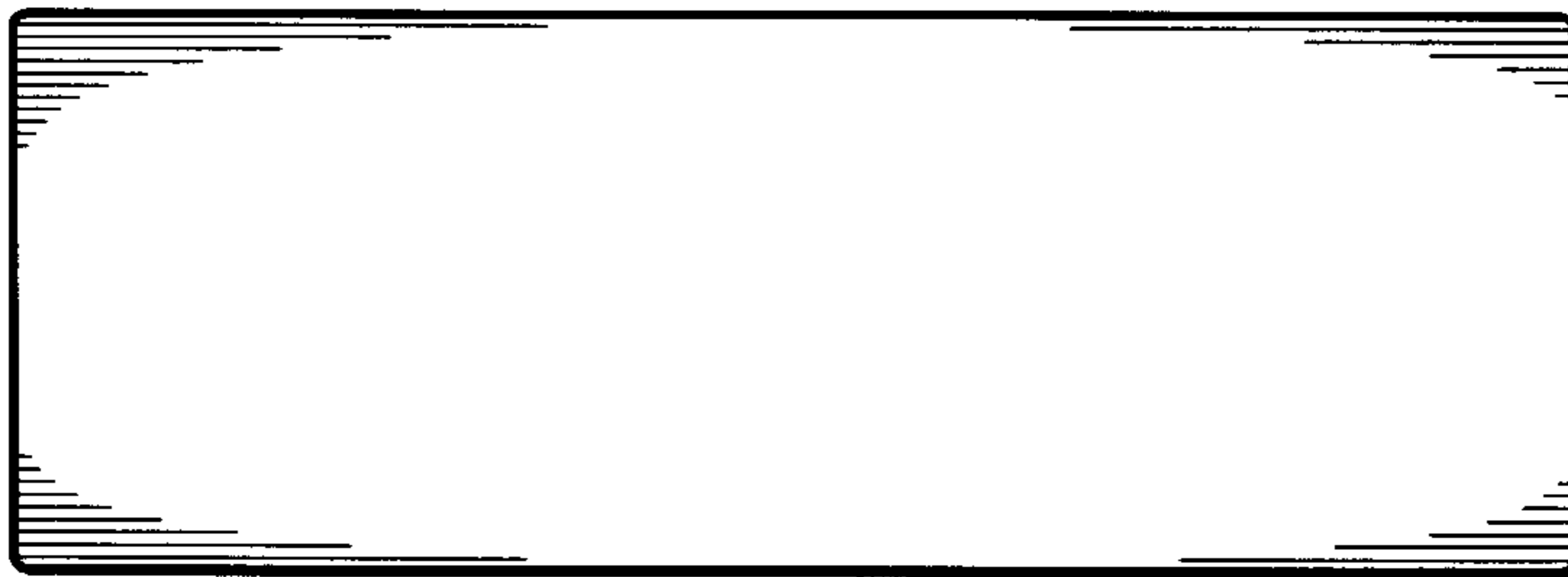

Fig. 8



Fig. 9



Fig. 10