



US00D417732S

United States Patent [19]

Dagsland et al.

[11] Patent Number: **Des. 417,732**

[45] Date of Patent: **** Dec. 14, 1999**

[54] **DRY POWDER INHALER WITH COVER**

[75] Inventors: **Allan Dagsland**, Karlshamn, Sweden;
Risto Virtanen, Nurmijärvi, Finland;
Steven McGugan, Lyngby, Denmark

[73] Assignee: **Astra Aktiebolag**, Sodertalje, Sweden

[*] Notice: This patent is subject to a terminal disclaimer.

[**] Term: **14 Years**

[21] Appl. No.: **29/094,245**

[22] Filed: **Sep. 29, 1998**

[30] **Foreign Application Priority Data**

Mar. 30, 1998 [SE] Sweden 98-0739

[51] **LOC (6) Cl.** **29-02**

[52] **U.S. Cl.** **D24/110**

[58] **Field of Search** D24/110; 128/203.15,
128/200.14, 205.13, 200.21, 200.23

[56] **References Cited**

U.S. PATENT DOCUMENTS

D. 348,928 7/1994 Ashley et al. D24/110

D. 377,686 1/1997 Waldeck et al. D24/110
D. 397,435 8/1998 Naumann D24/110
2,966,909 1/1961 Halperin D24/110 X
5,331,953 7/1994 Andersson et al. 128/203.15 X

Primary Examiner—Stella Reid
Assistant Examiner—I Simmons
Attorney, Agent, or Firm—Fish & Richardson P.C.

[57] **CLAIM**

The ornamental design for a dry powder inhaler with cover, as shown and described.

DESCRIPTION

FIG. 1 is a perspective view of the inhaler with the cover attached.
FIG. 2 is a perspective view showing the inhaler and the cover disconnected from each other.
FIG. 3 is a front elevation of the inhaler.
FIG. 4 is a back elevation of the inhaler.
FIG. 5 is a bottom view of the inhaler.
FIG. 6 is a left side view of the inhaler.
FIG. 7 is a right side view of the inhaler.
FIG. 8 is a top view of the inhaler.
FIG. 9 is a side view of the cover for the inhaler.
FIG. 10 is a top view of the cover; and,
FIG. 11 is a bottom view of the cover.

1 Claim, 4 Drawing Sheets

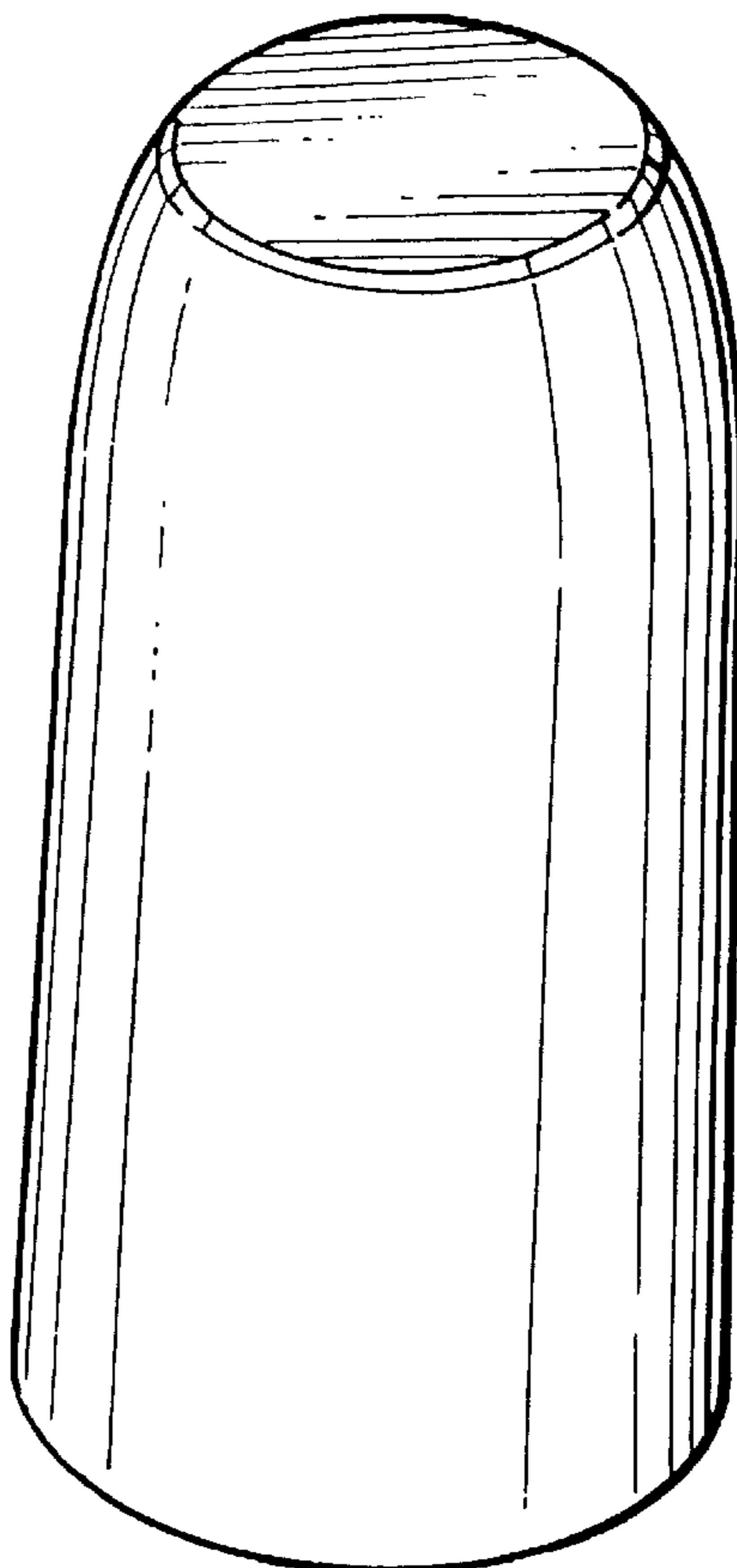
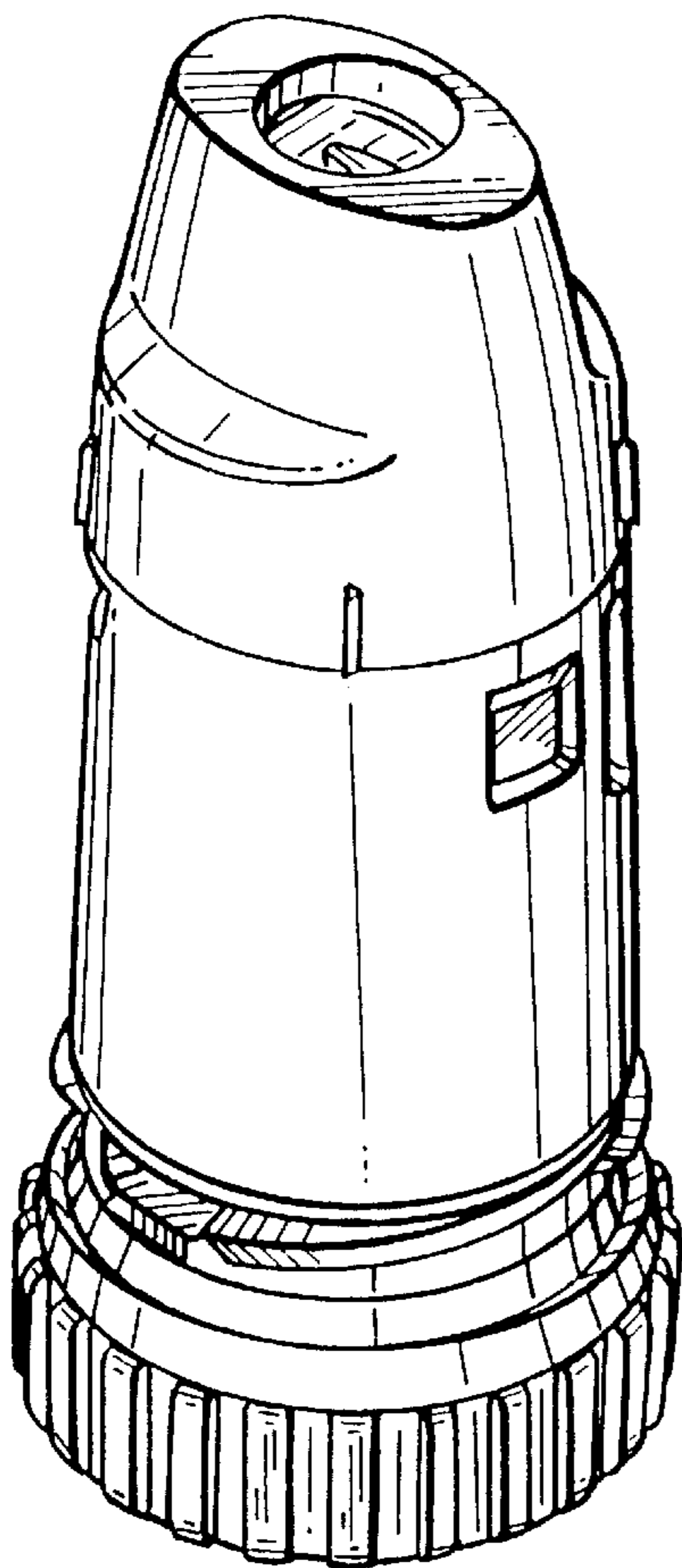

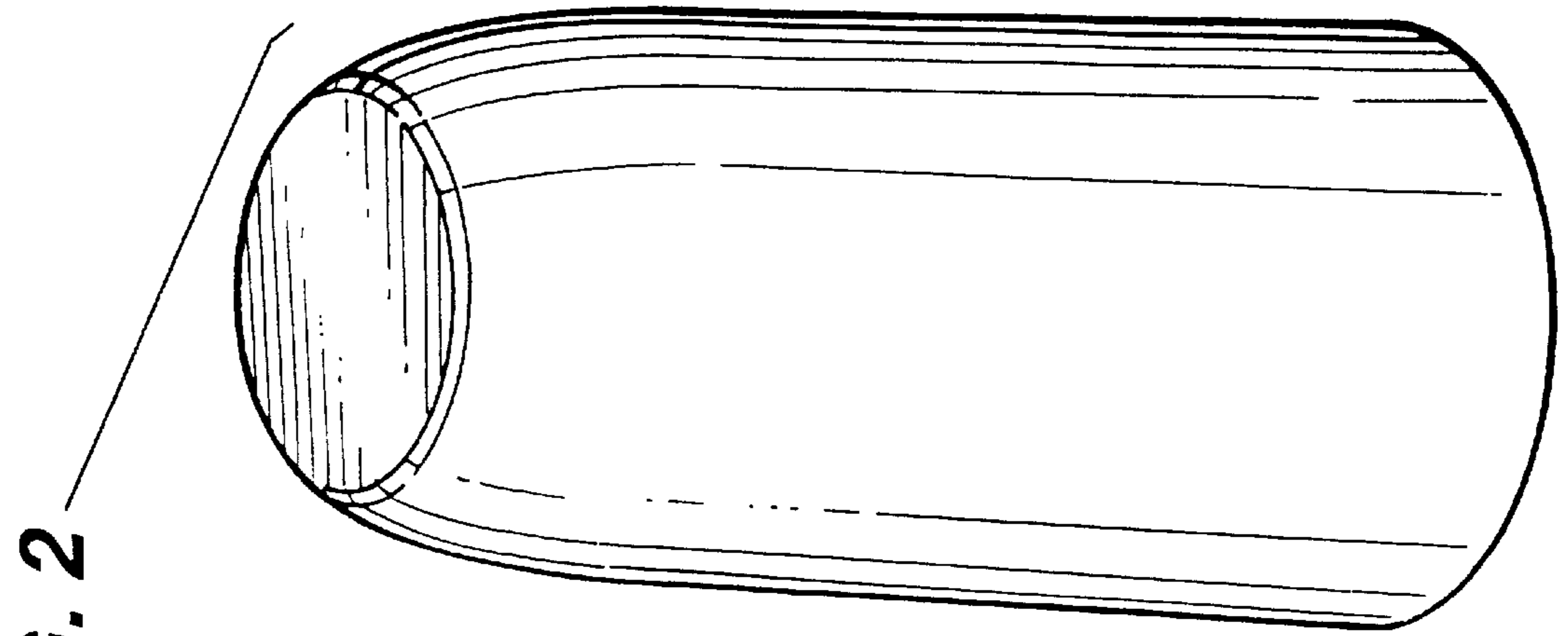

FIG. 2

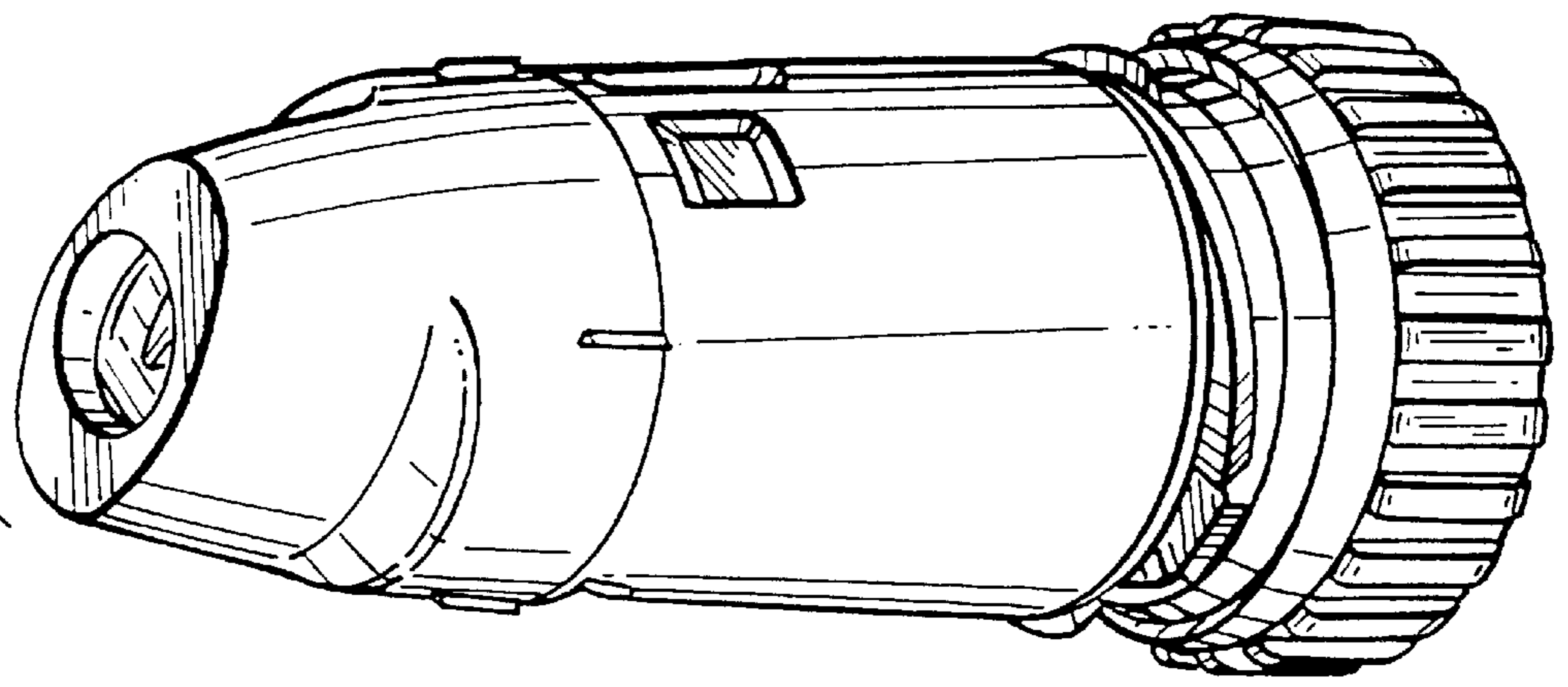

FIG. 1

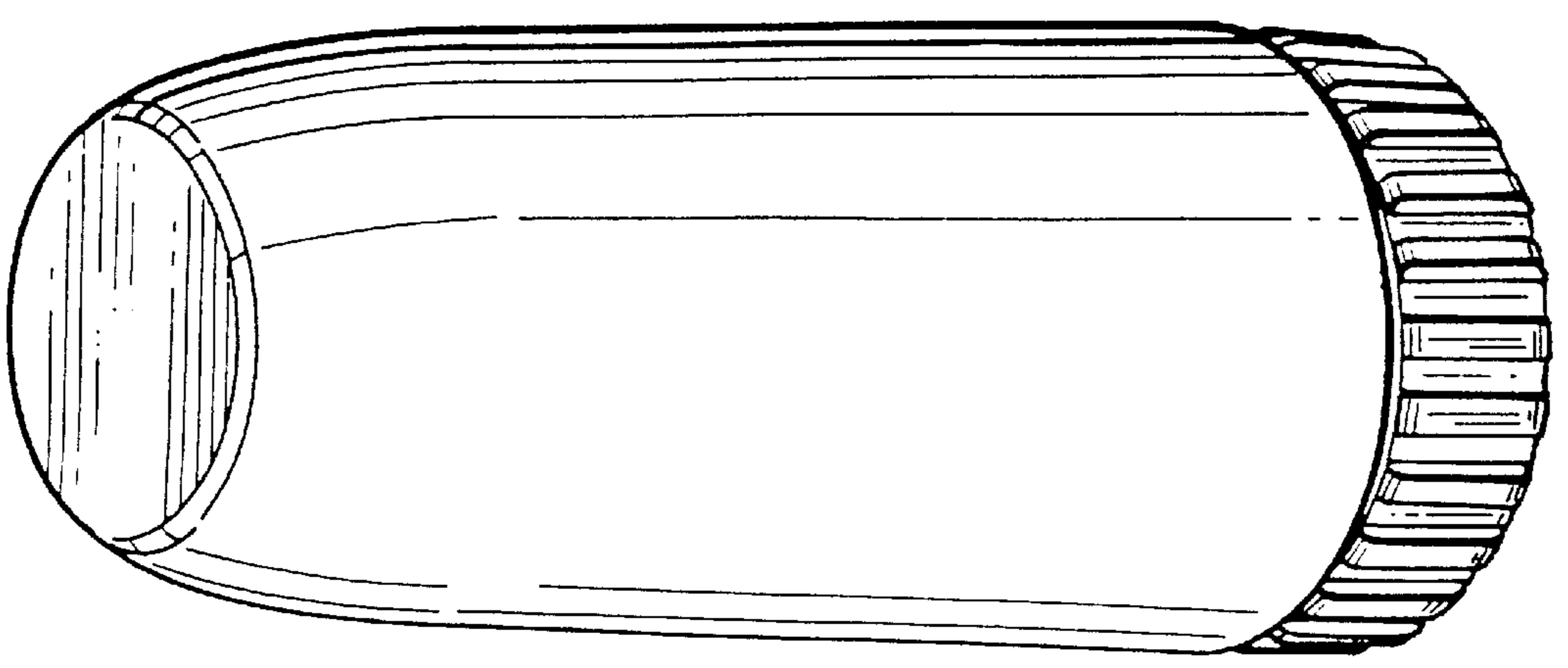

FIG. 4

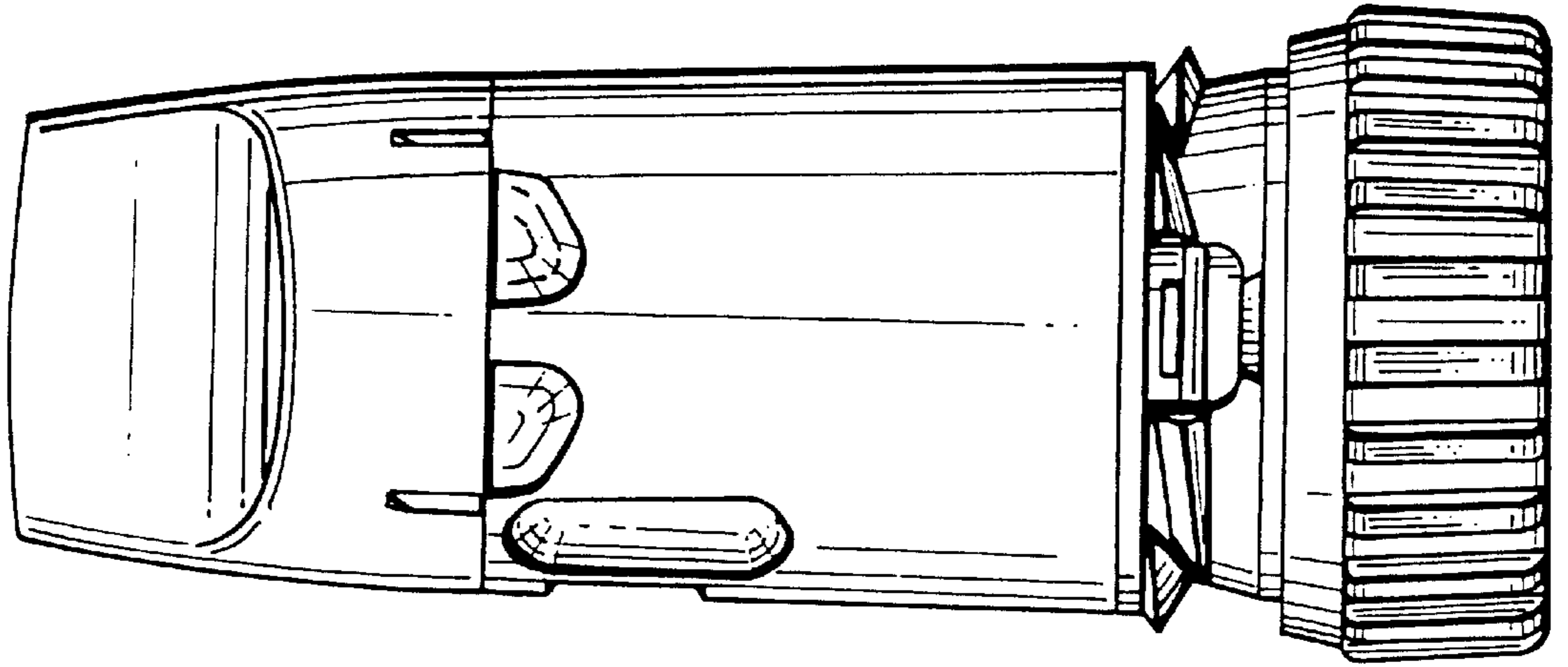

FIG. 3

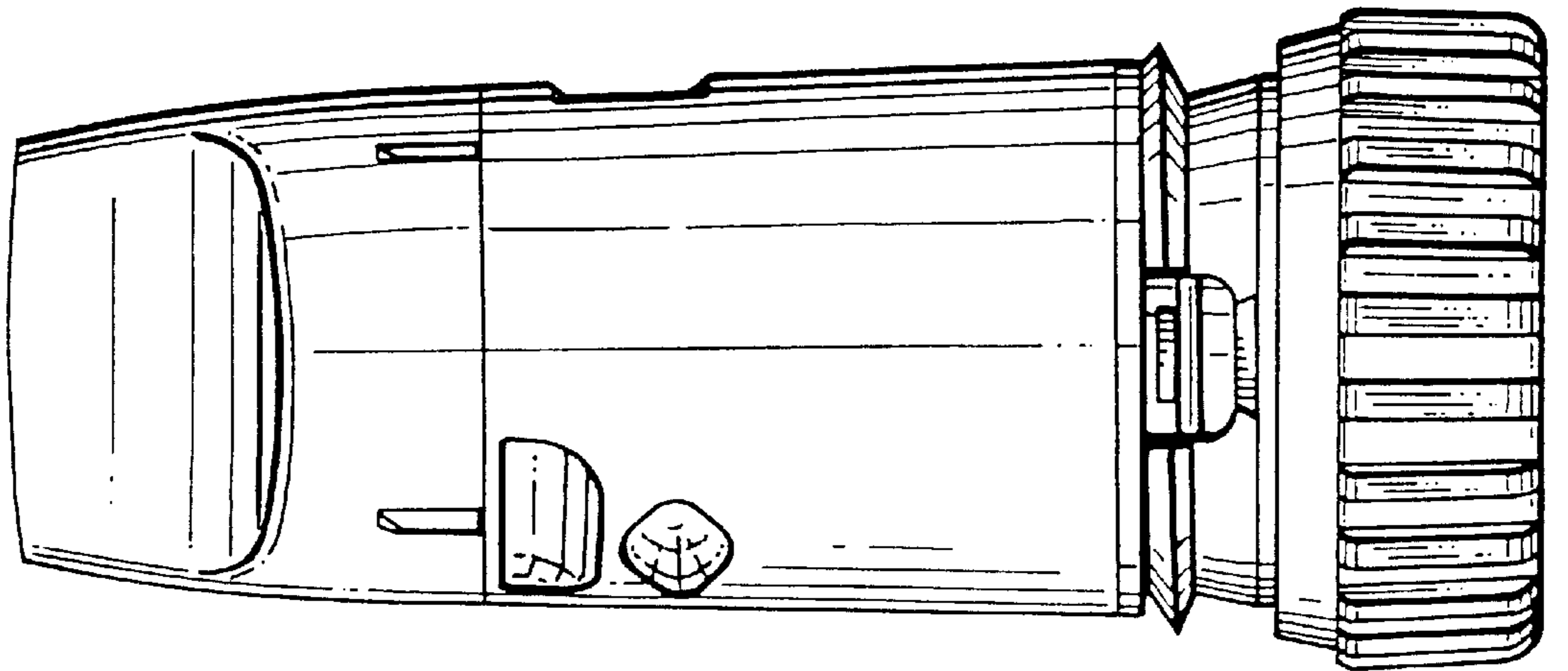

FIG. 5

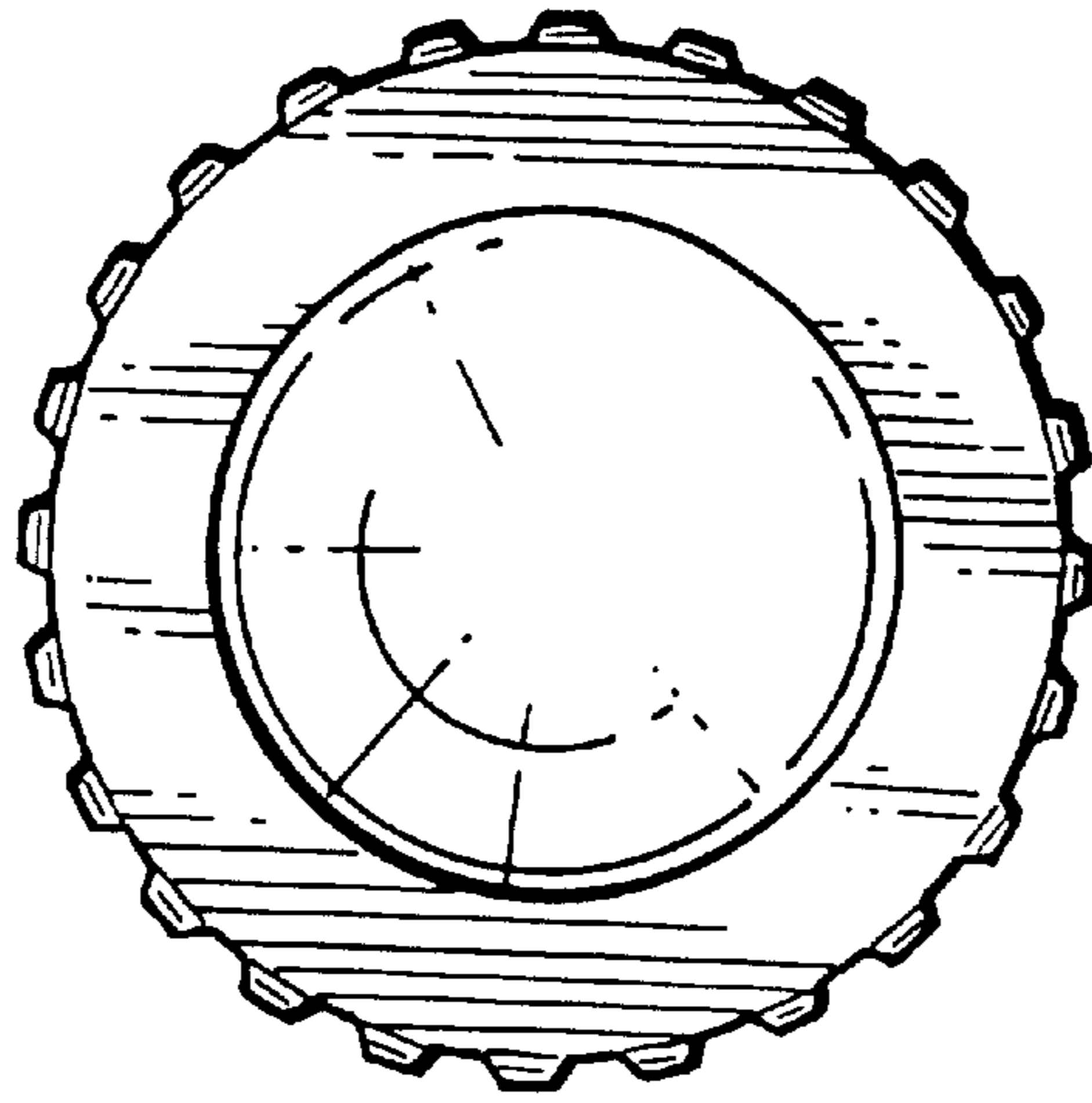

FIG. 7

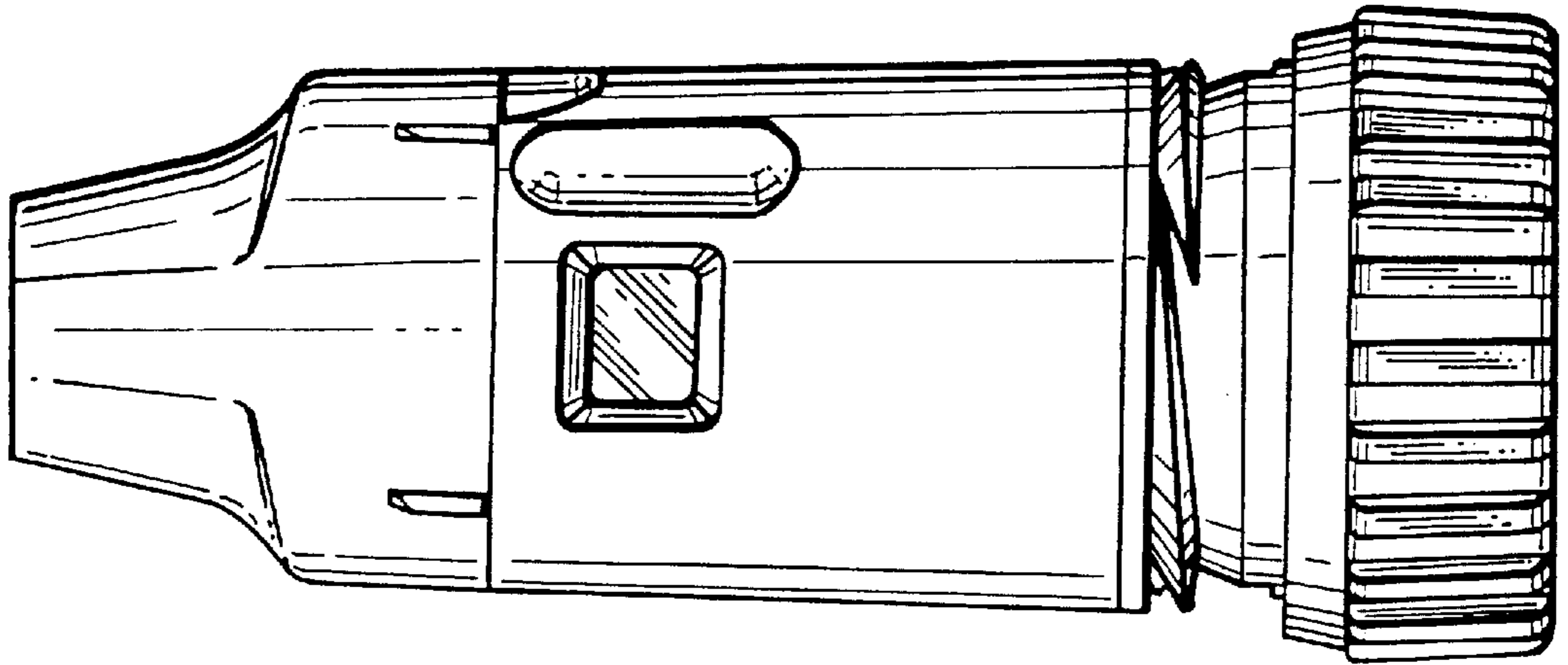

FIG. 6

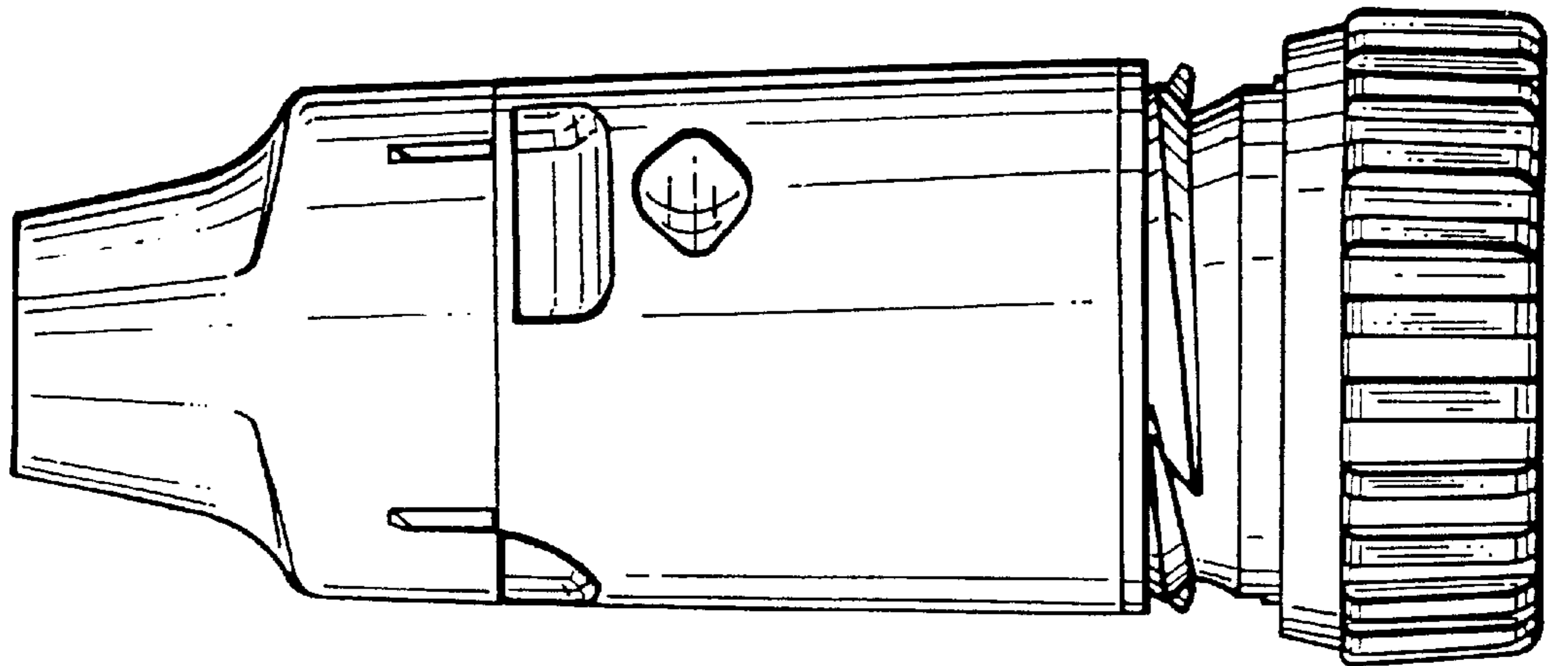

FIG. 8

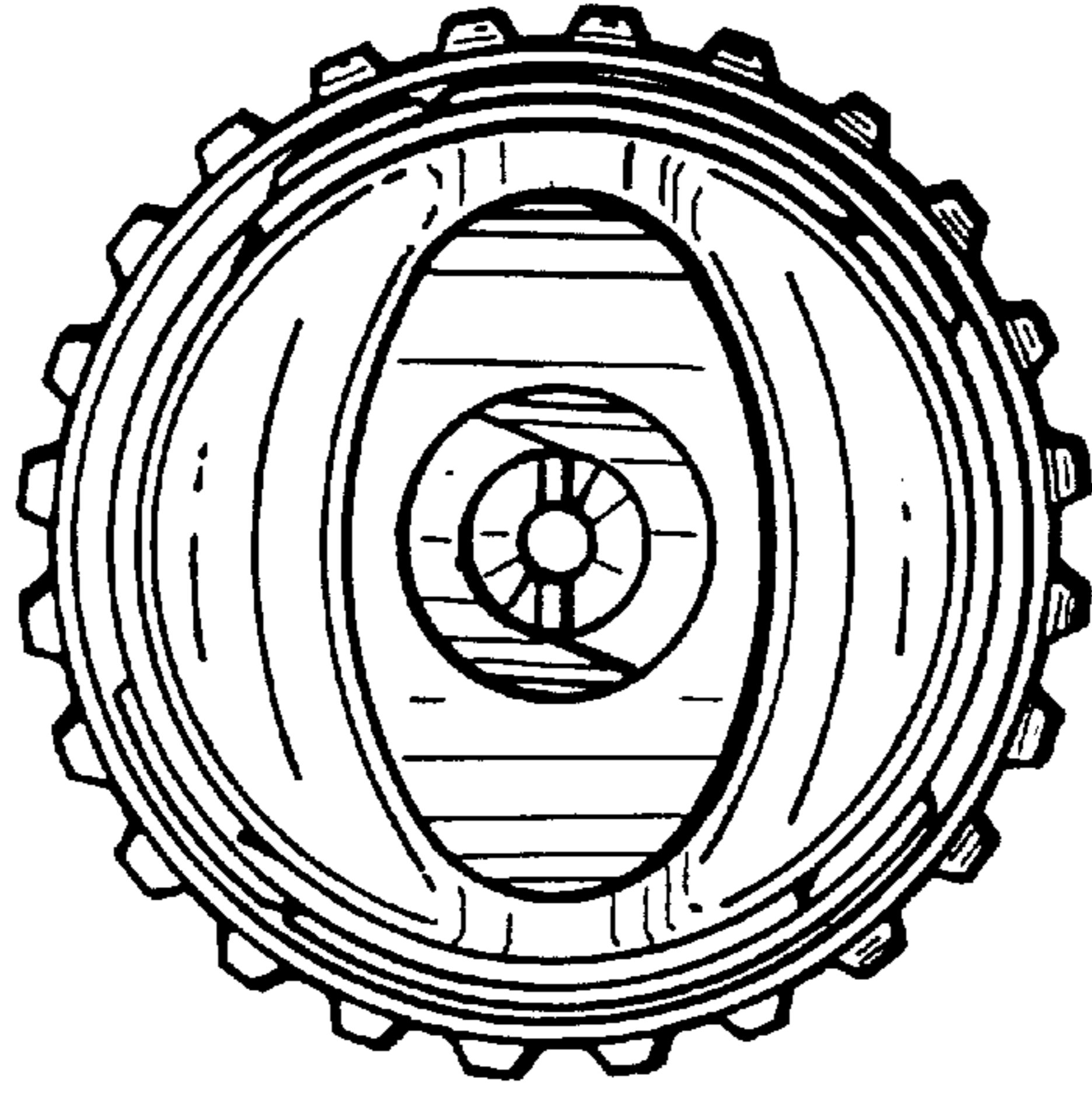

FIG. 9

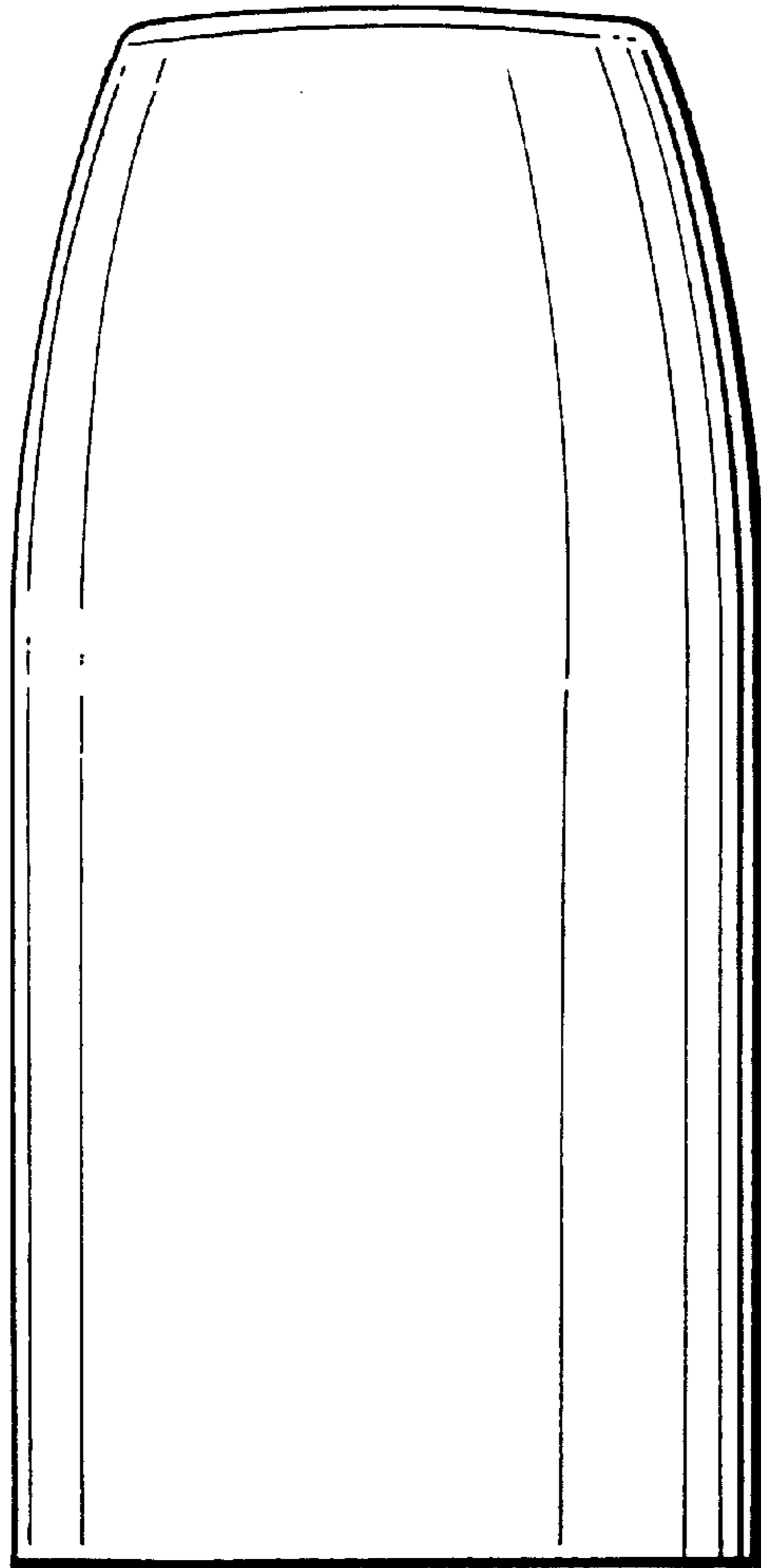

FIG. 10

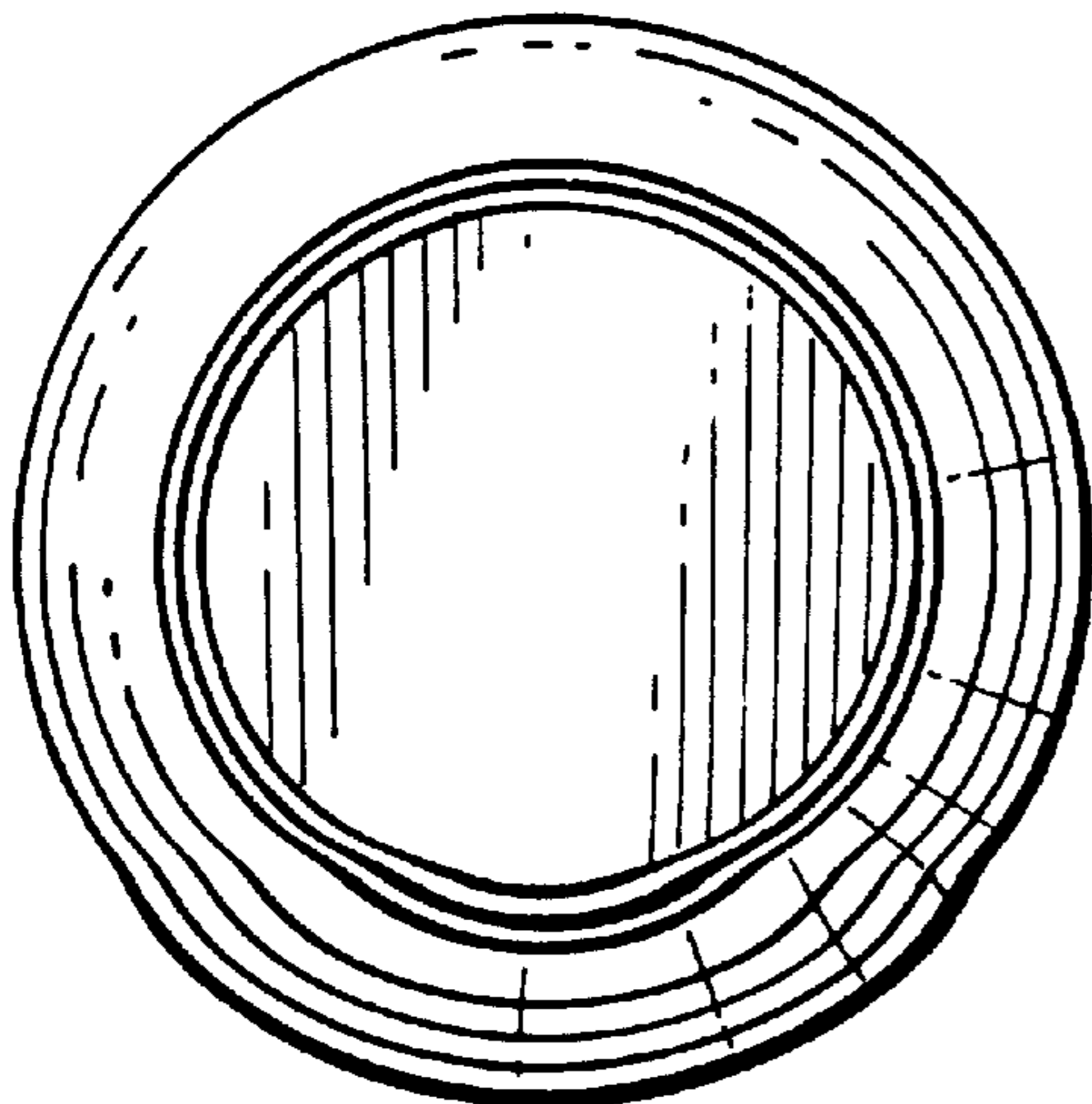

FIG. 11

