



US00D417623S

# United States Patent [19]

Zimmer et al.

[11] Patent Number: Des. 417,623

[45] Date of Patent: \*\* Dec. 14, 1999

[54] CONTAINER

[75] Inventors: Gregory Alan Zimmer, Cincinnati, Ohio; Glenn Ilustre de Guzman, Kobe; Ryoichi Tomishima, Hyogo, both of Japan

[73] Assignee: Procter & Gamble Co., Cincinnati, Ohio

[\*\*] Term: 14 Years

[21] Appl. No.: 29/084,654

[22] Filed: Mar. 6, 1998

[51] LOC (6) Cl. .... 09-01

[52] U.S. Cl. .... D9/552

[58] Field of Search ..... D9/552, 556, 500, D9/501, 503, 545, 505, 300, 301; 215/381, 383, 384

### [56] References Cited

#### U.S. PATENT DOCUMENTS

- D. 398,855 9/1998 Ito ..... D9/537
- D. 406,765 3/1999 Zimmer et al. .... D9/523

#### FOREIGN PATENT DOCUMENTS

- 648625 4/1985 Japan .
- 658456 8/1985 Japan .
- 671267 2/1986 Japan .
- 862853 3/1993 Japan .

Primary Examiner—Dominic Simone  
Attorney, Agent, or Firm—William Scott Andes; James C. Vago

### [57] CLAIM

The ornamental design for a container, as shown and described.

### DESCRIPTION

FIG. 1 is a perspective view of a container embodying our new design;  
 FIG. 2 is a front side elevational view thereof, the rear side elevational view being the same;  
 FIG. 3 is a top plan view thereof;  
 FIG. 4 is a bottom plan view thereof;  
 FIG. 5 is a right side elevational view thereof, the left side elevational view being the same;  
 FIG. 6 is a cross-sectional view taken on the line I—I of FIG. 2.  
 FIG. 7 is a perspective view of the container;  
 FIG. 8 is a front side elevational view thereof, the rear side elevational view being a mirror-image;  
 FIG. 9 is a top plan view thereof;  
 FIG. 10 is a bottom plan view thereof;  
 FIG. 11 is a right side elevational view thereof;  
 FIG. 12 is a left side elevational view thereof; and,  
 FIG. 13 is a cross-sectional view taken on the line II—II of FIG. 8.  
 The broken line showing of a sprayer head is for illustrative purpose only and forms no part of the claimed design.

1 Claim, 13 Drawing Sheets

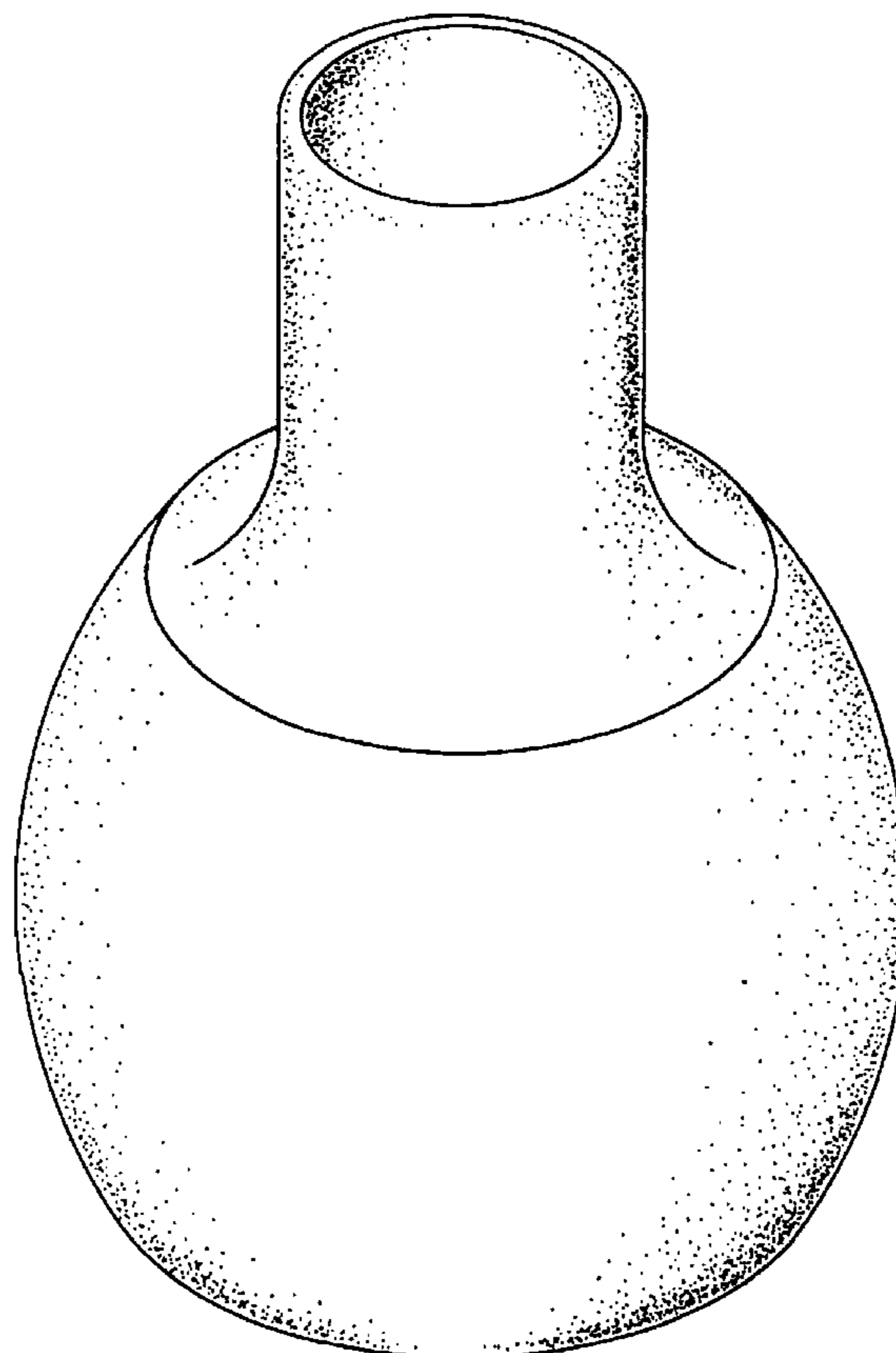

FIG. 1

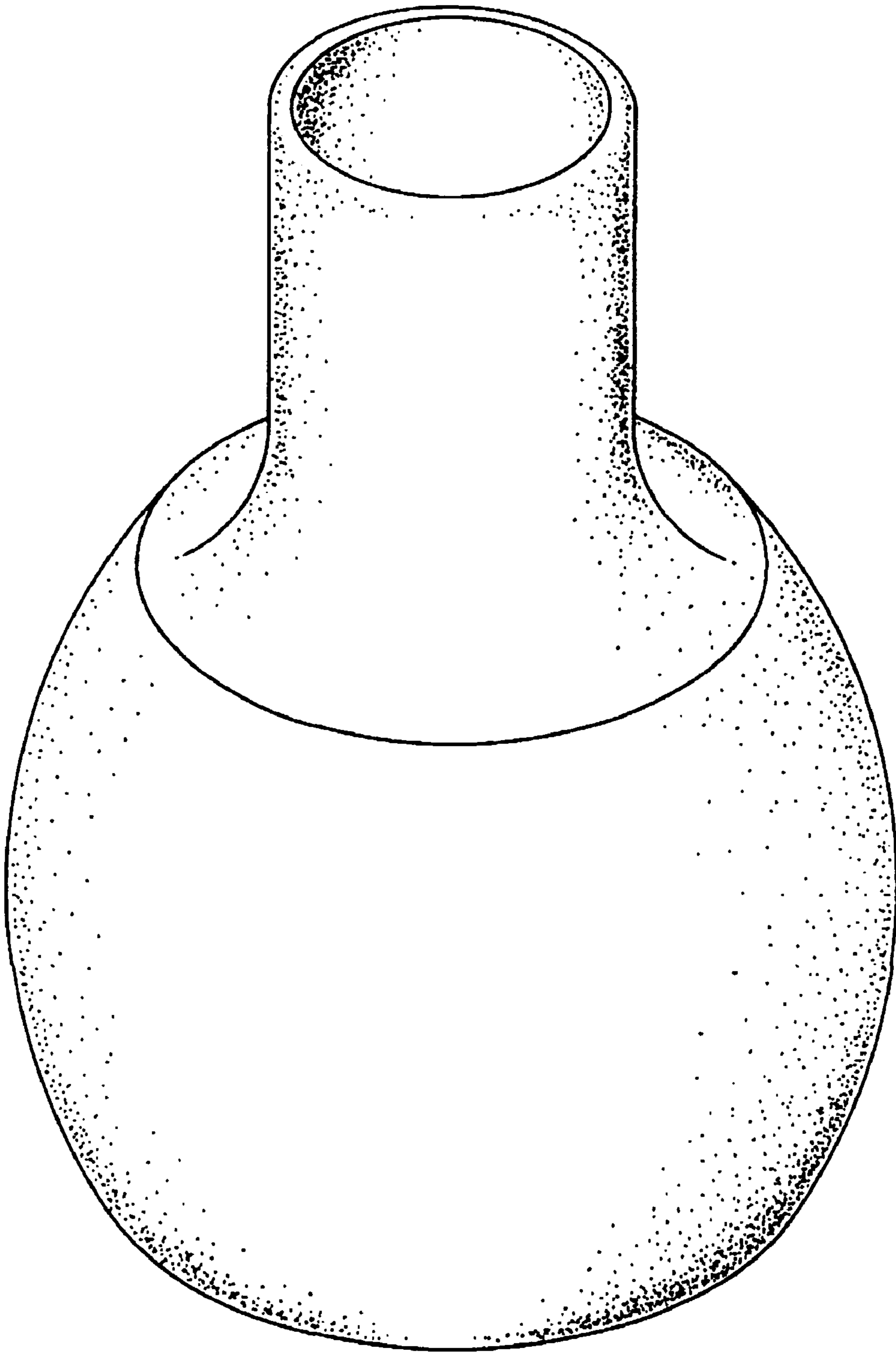

FIG. 2

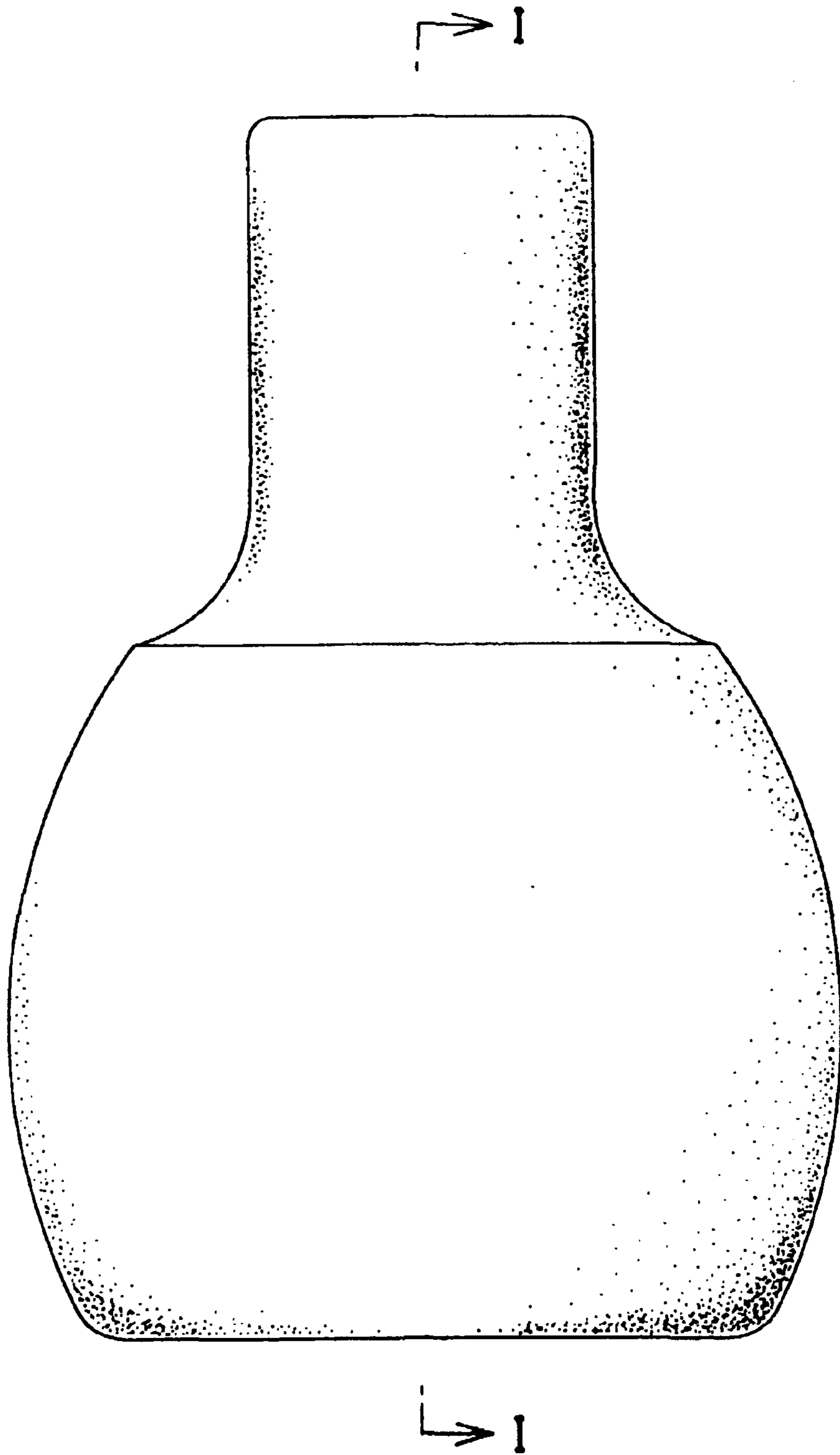

FIG. 3

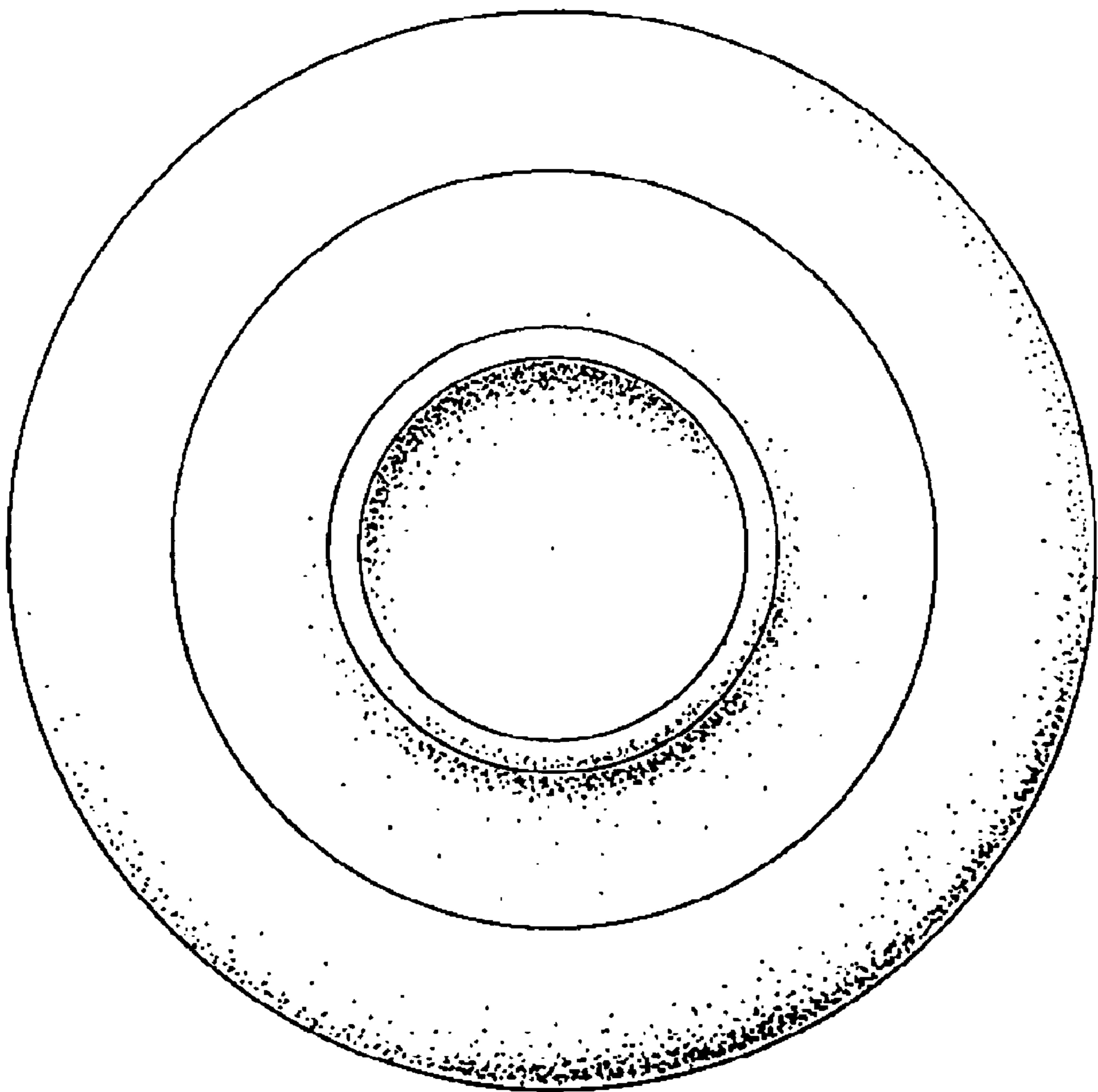

FIG. 4

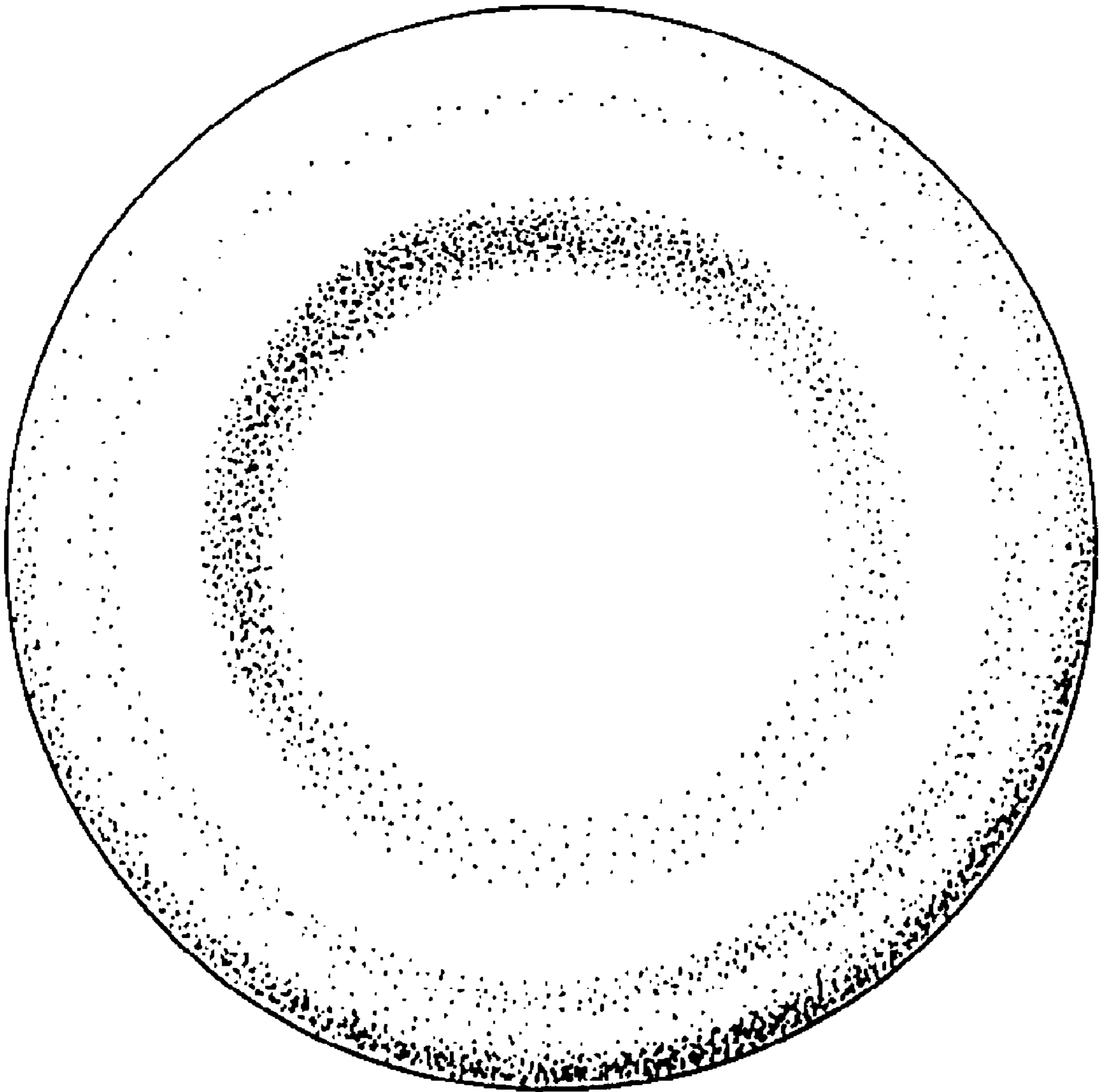

FIG. 5

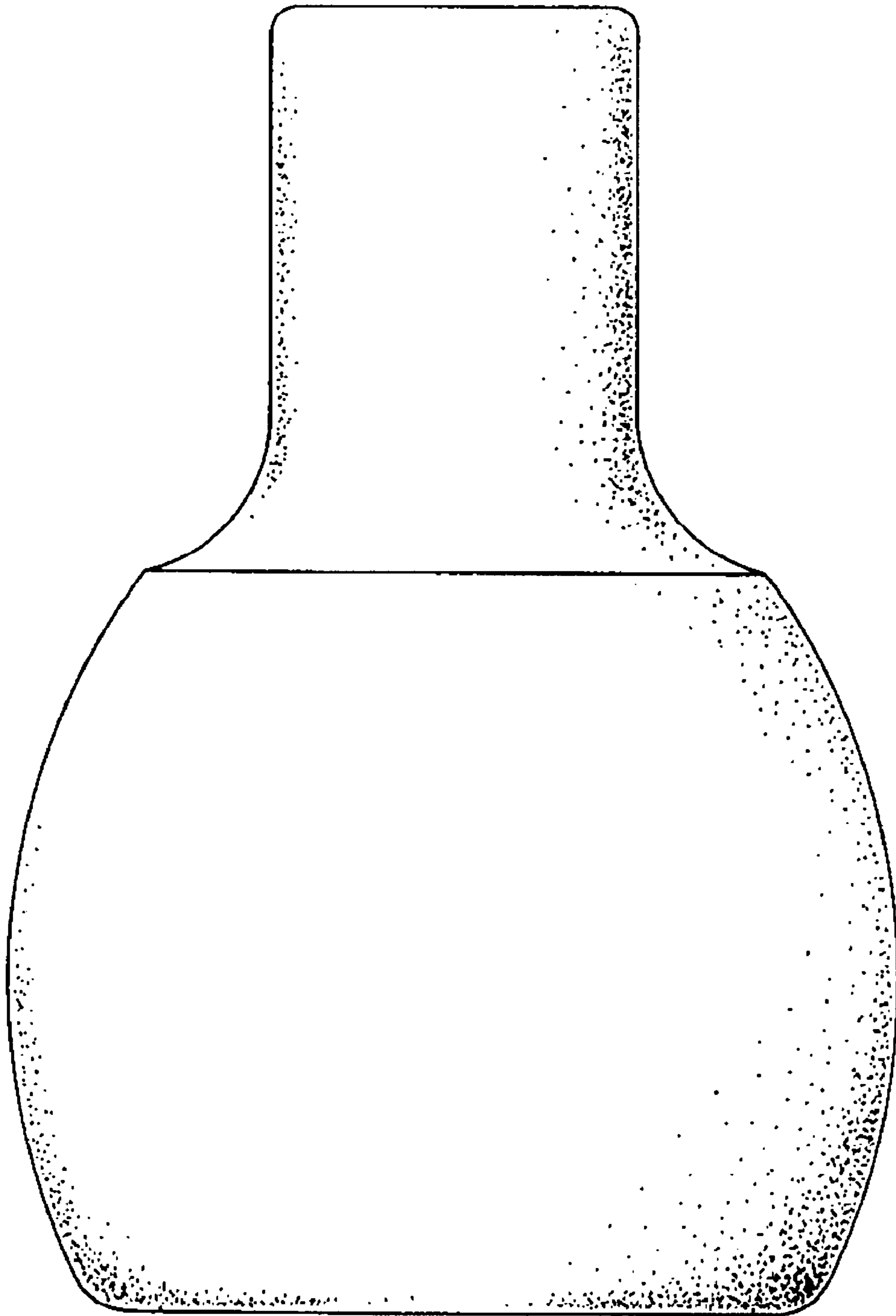



FIG. 6

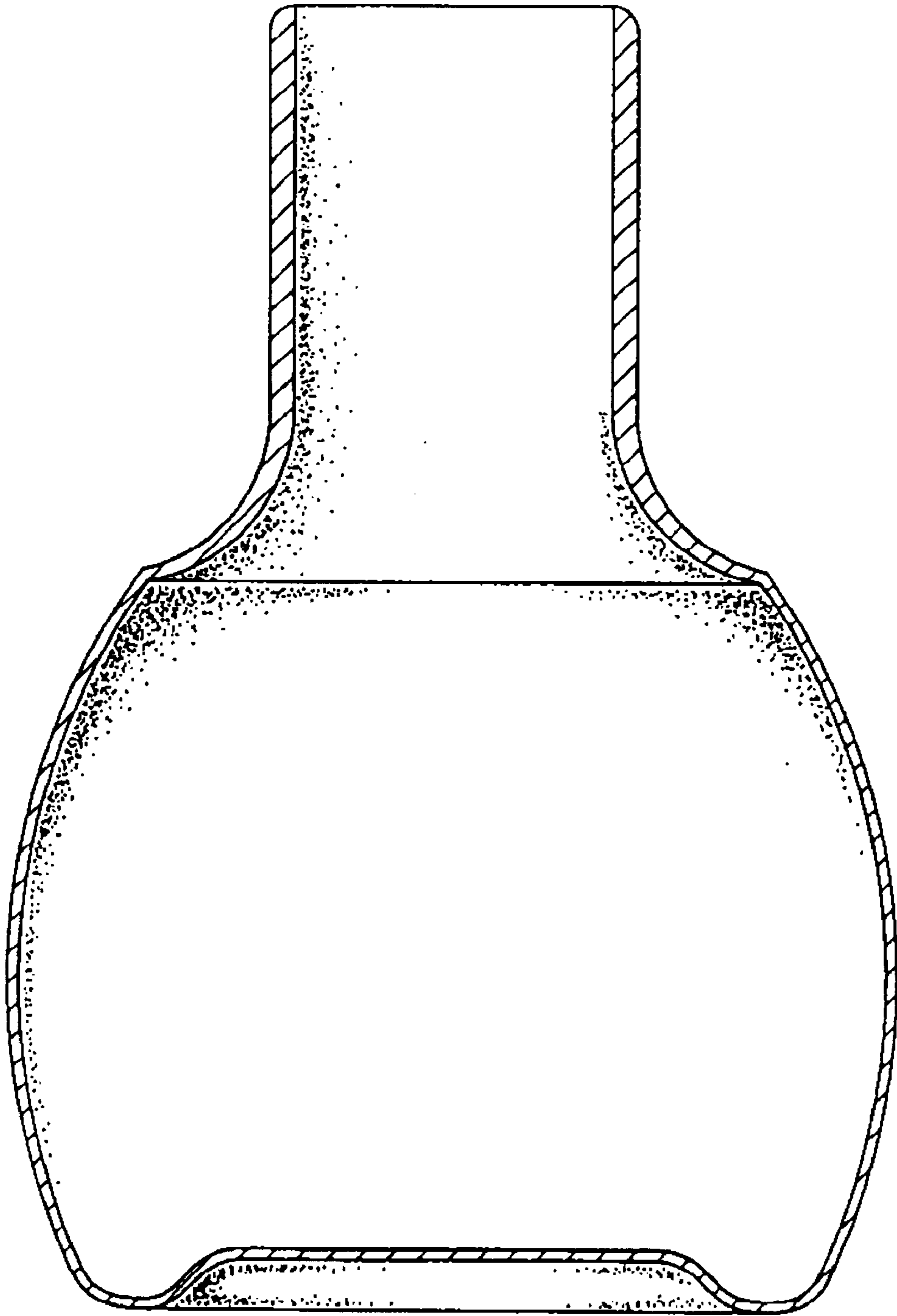

FIG. 7

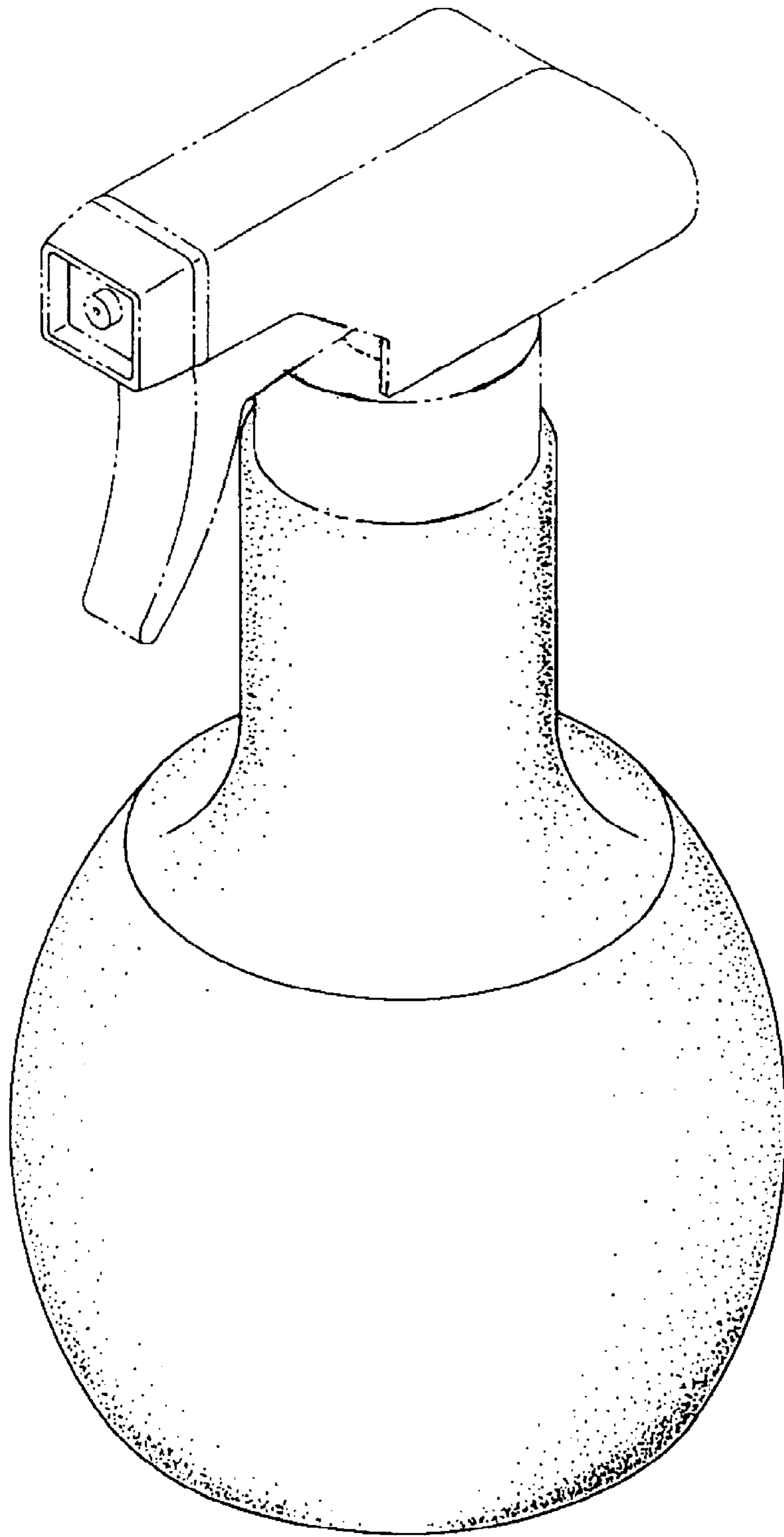



FIG. 8

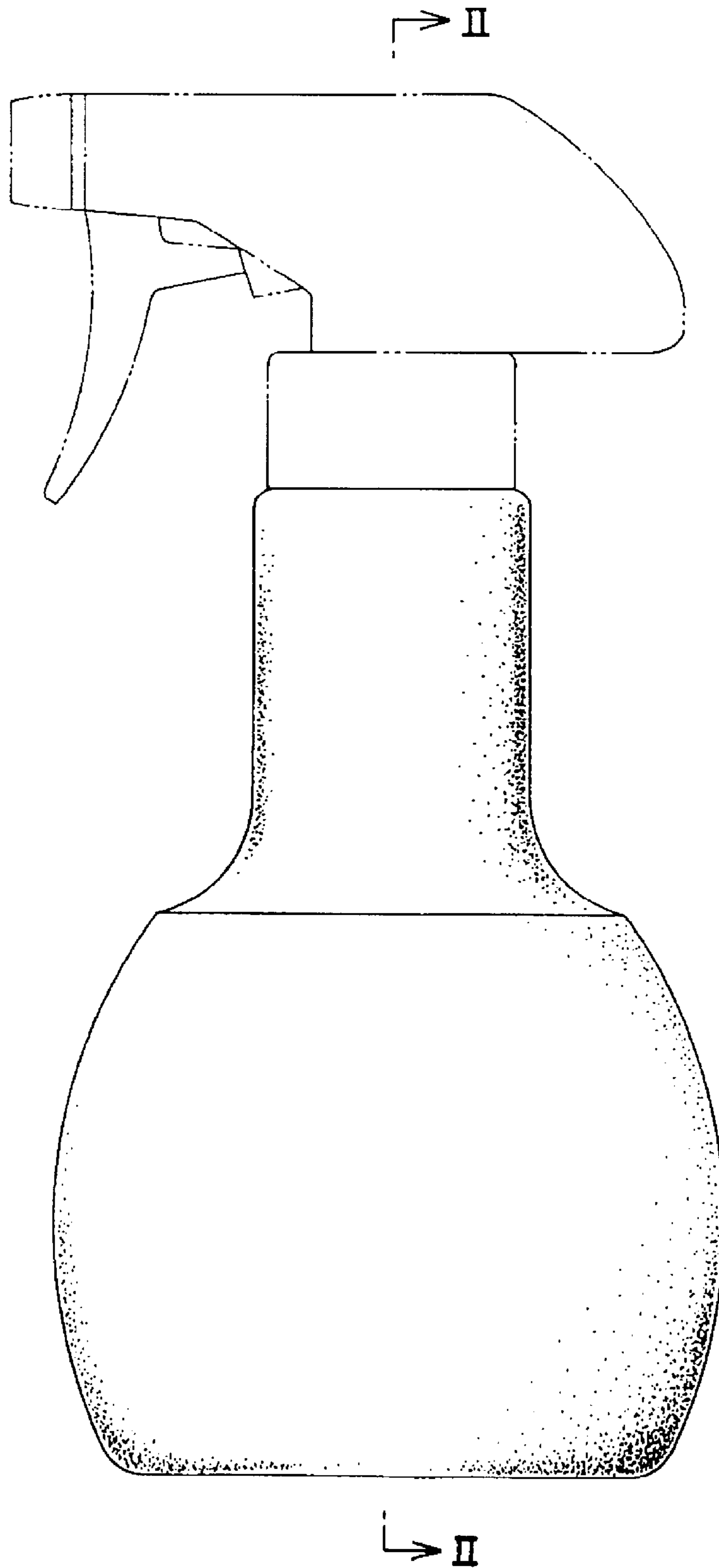

FIG. 9

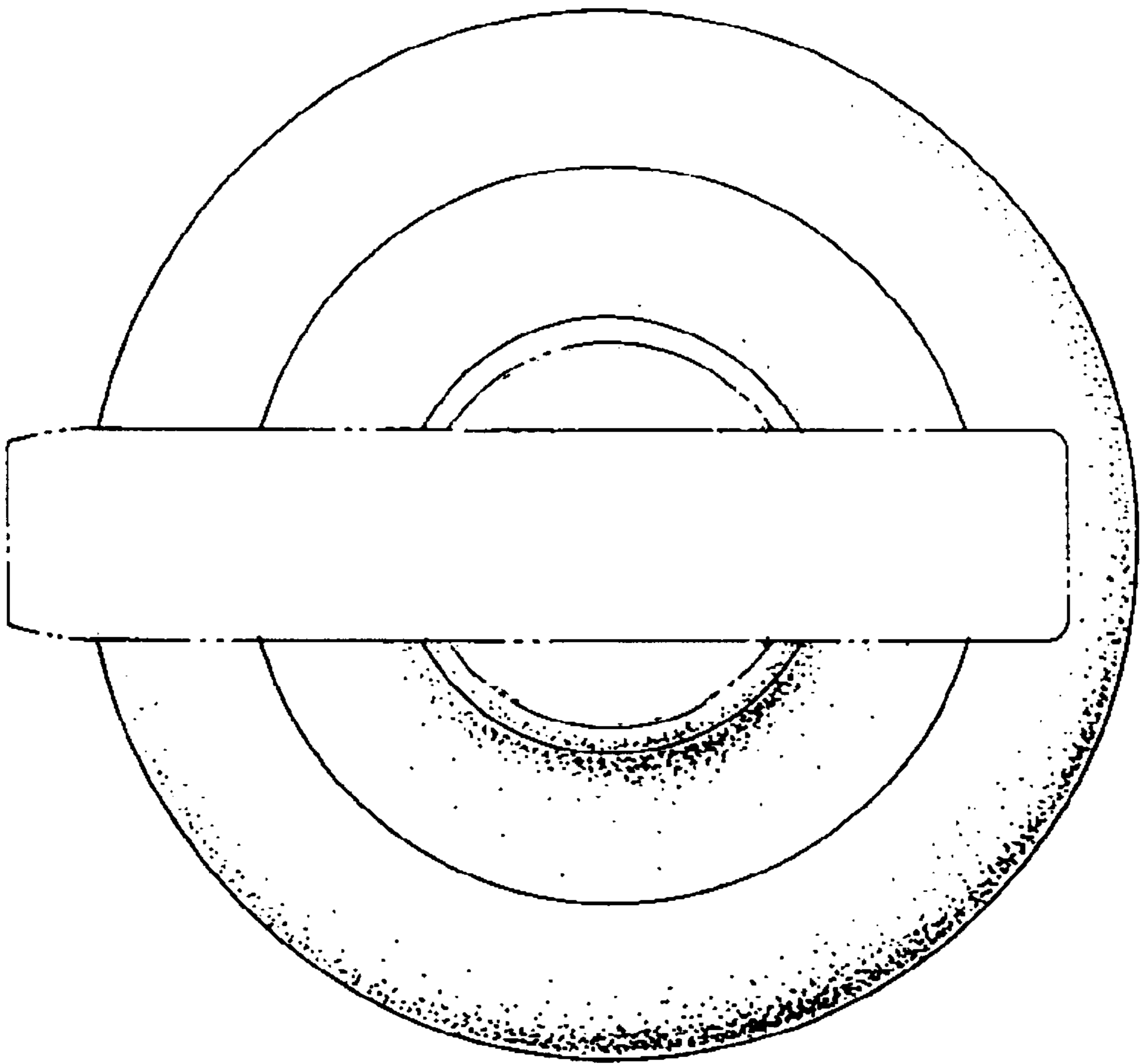

FIG. 10

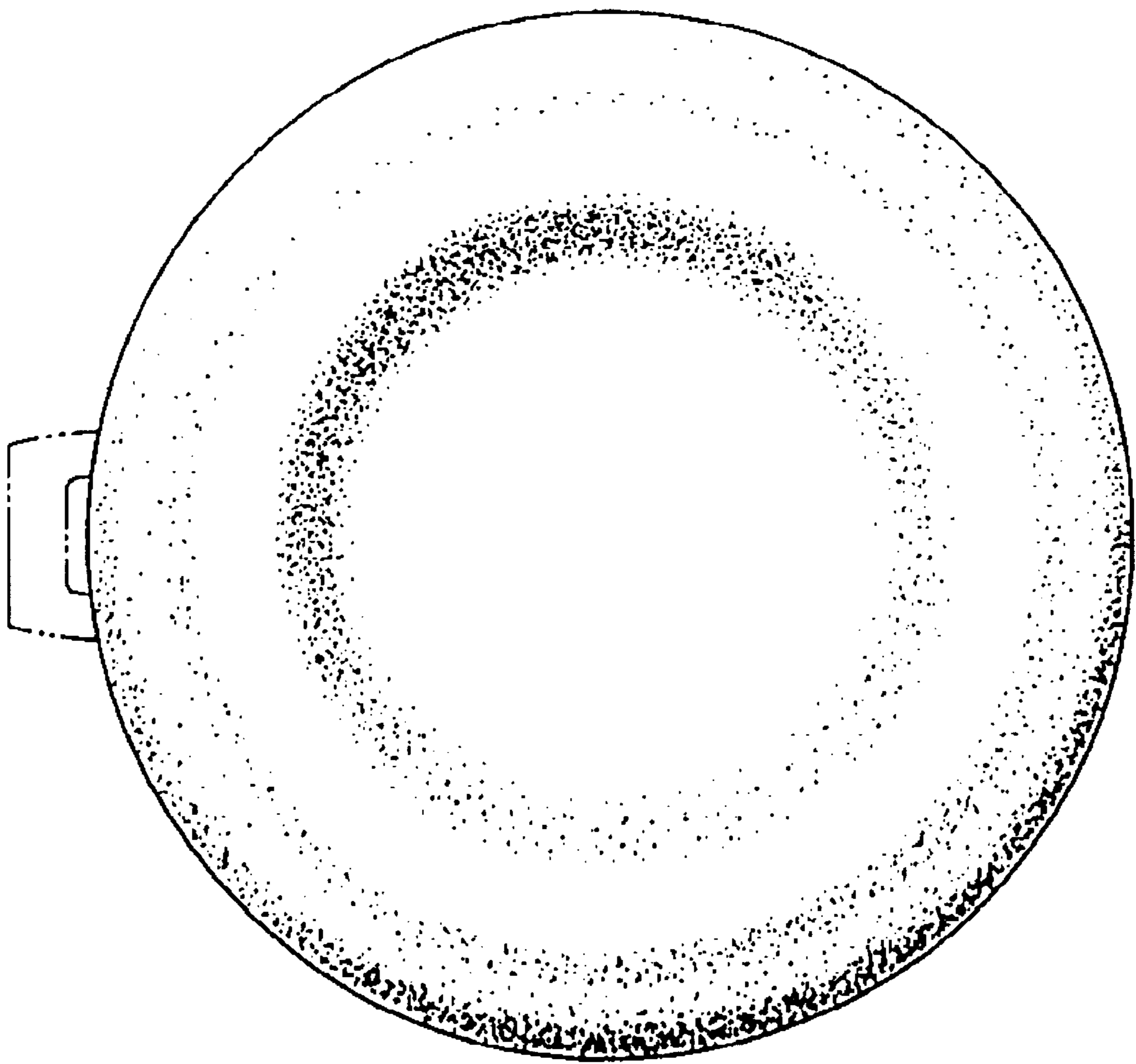

FIG. 11

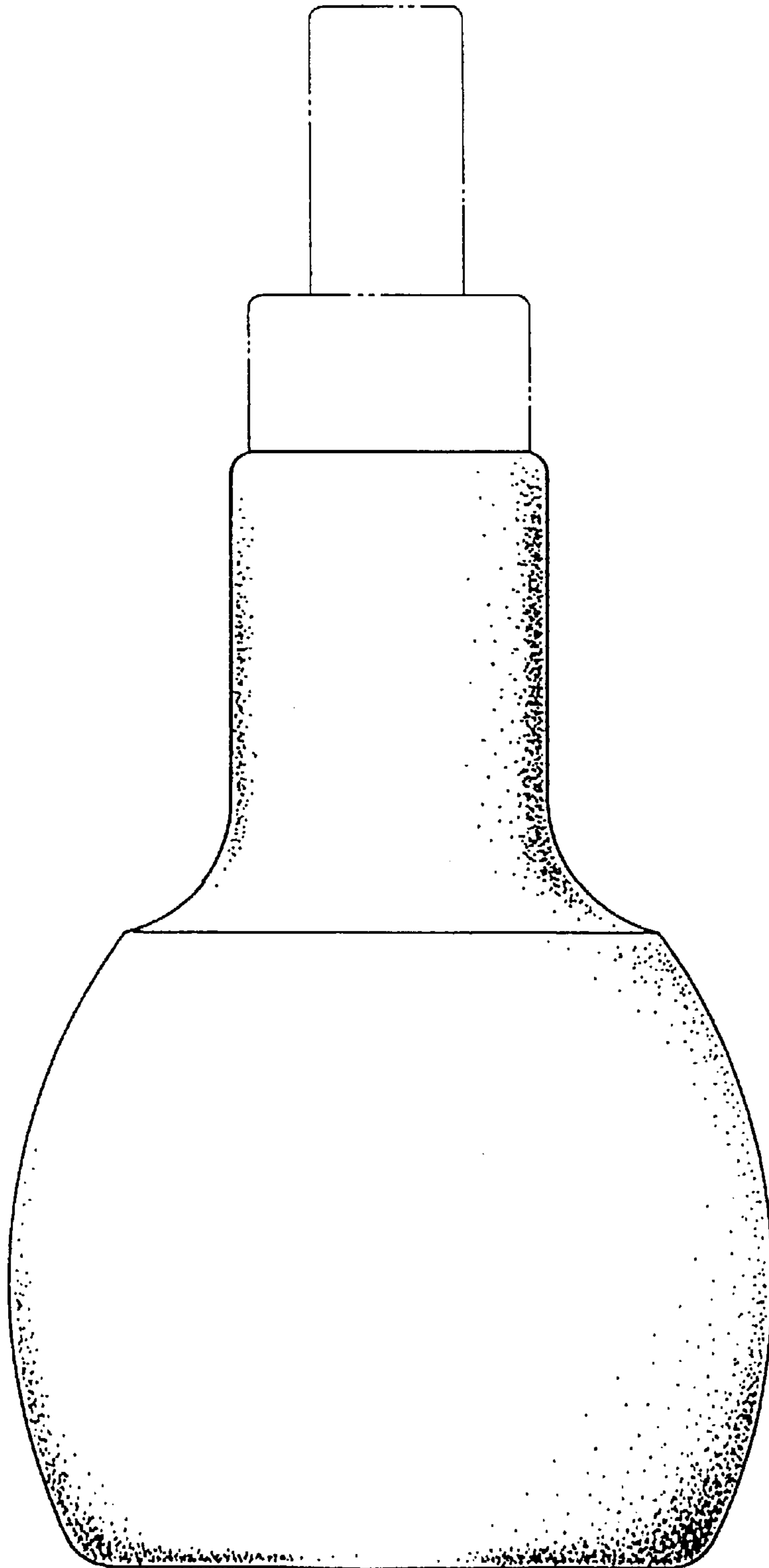

FIG. 12

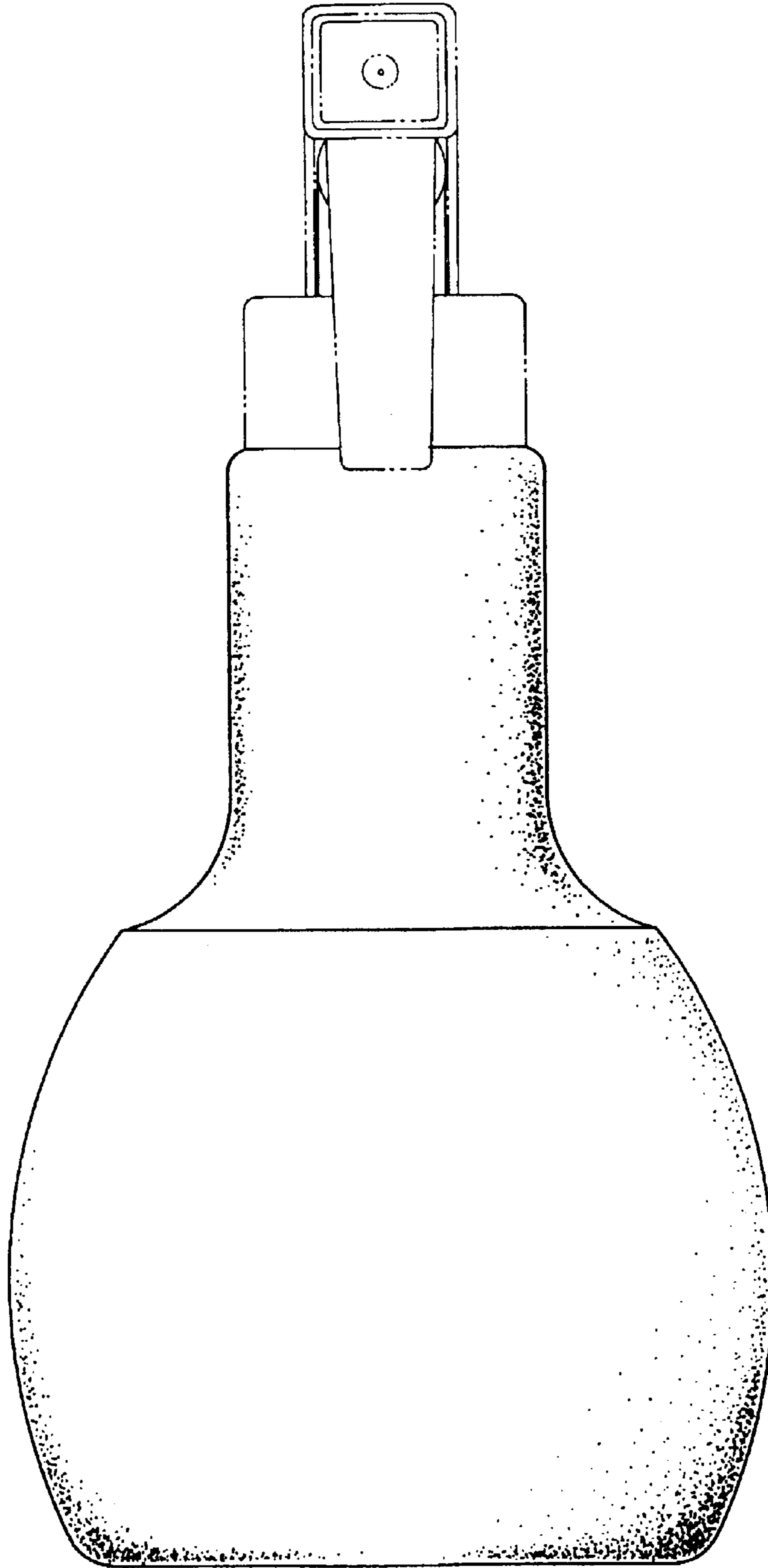

FIG. 13

