



US00D417606S

United States Patent [19]

Bries et al.

[11] Patent Number: **Des. 417,606**

[45] Date of Patent: **** Dec. 14, 1999**

[54] **WALL HOOK**

[75] Inventors: **James L. Bries**, Cottage Grove;
Pauline M. Pieper, Saint Paul; **Paul E. Raber**, North Saint Paul, all of Minn.;
Michael P. Zambelli, Livingston;
Mark E. Millman, Keyport, both of N.J.; **David J. Mayer**, New York, N.Y.

[73] Assignee: **Minnesota Mining and Manufacturing Company**, St. Paul, Minn.

[**] Term: **14 Years**

[21] Appl. No.: **29/092,278**

[22] Filed: **Aug. 14, 1998**

[51] **LOC (6) Cl.** **08-05**

[52] **U.S. Cl.** **D8/367**

[58] **Field of Search** D8/367; D6/323;
248/301, 304, 339, 215

[56] **References Cited**

U.S. PATENT DOCUMENTS

D. 386,067 11/1997 Hamerski et al. .

D. 389,037	1/1998	Bries et al. .	
D. 389,399	1/1998	Bries et al.	D8/367
D. 390,448	2/1998	Bries et al. .	
D. 390,453	2/1998	Hamerski et al. .	
D. 392,181	3/1998	Bries et al. .	
D. 393,412	4/1998	Bries et al.	D8/367
D. 393,414	4/1998	Bries et al. .	
D. 395,594	6/1998	Bries et al.	D8/367

Primary Examiner—Holly Baynham
Attorney, Agent, or Firm—David B. Patchett

[57] **CLAIM**

The ornamental design for a wall hook, as shown and described.

DESCRIPTION

FIG. 1 is a perspective view of a wall hook showing our new design;
FIG. 2 is a front view thereof;
FIG. 3 is a rear view thereof;
FIG. 4 is a side view thereof;
FIG. 5 is a top view thereof; and,
FIG. 6 is a bottom view thereof.

1 Claim, 2 Drawing Sheets

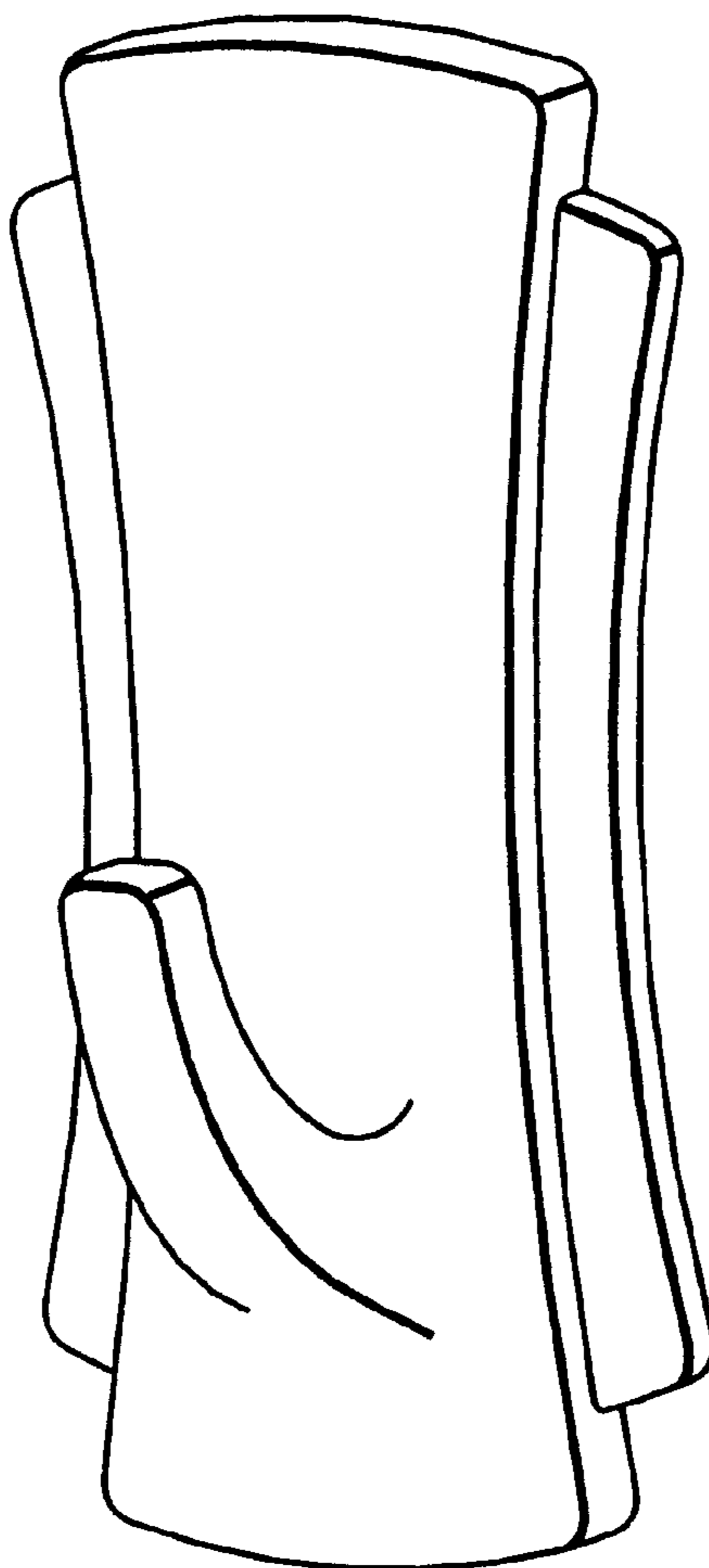

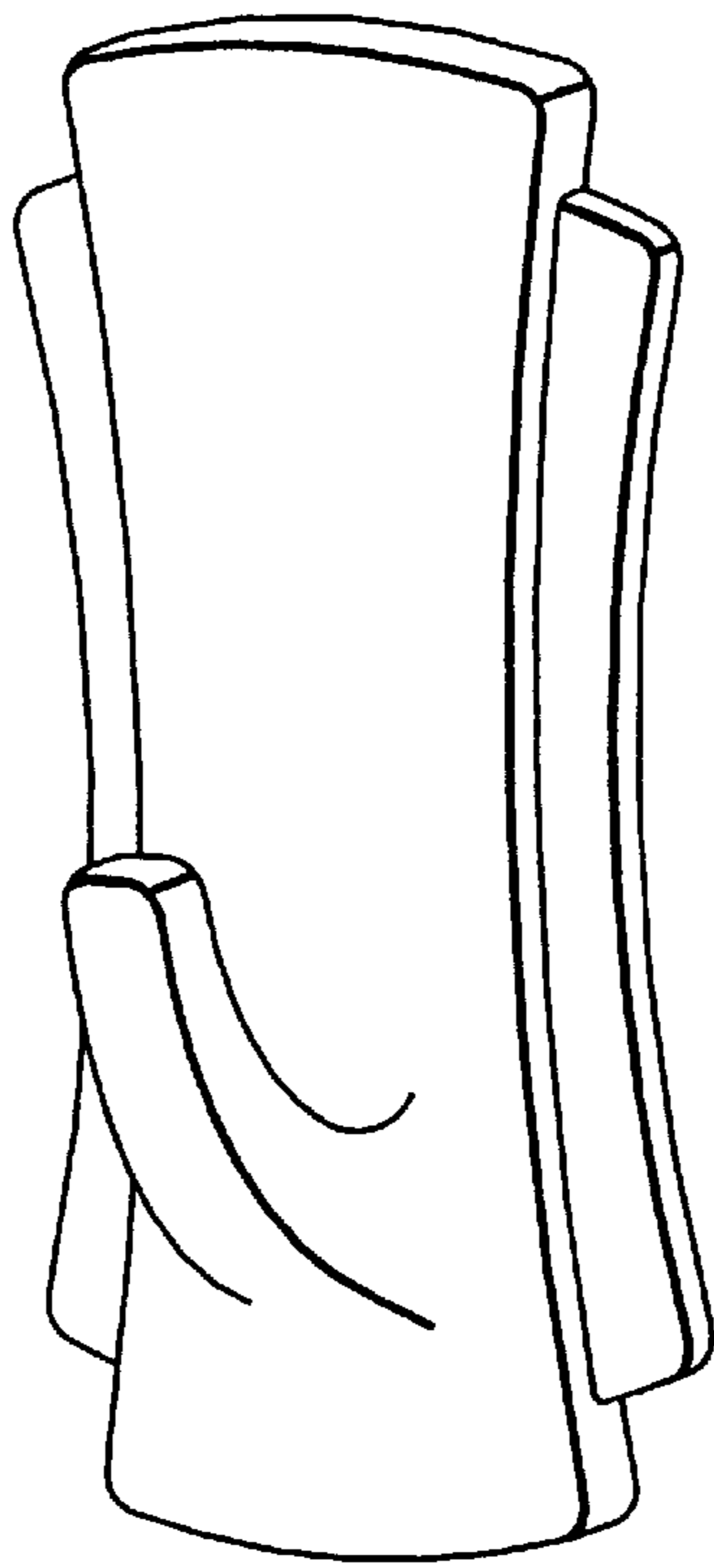

Fig. 1

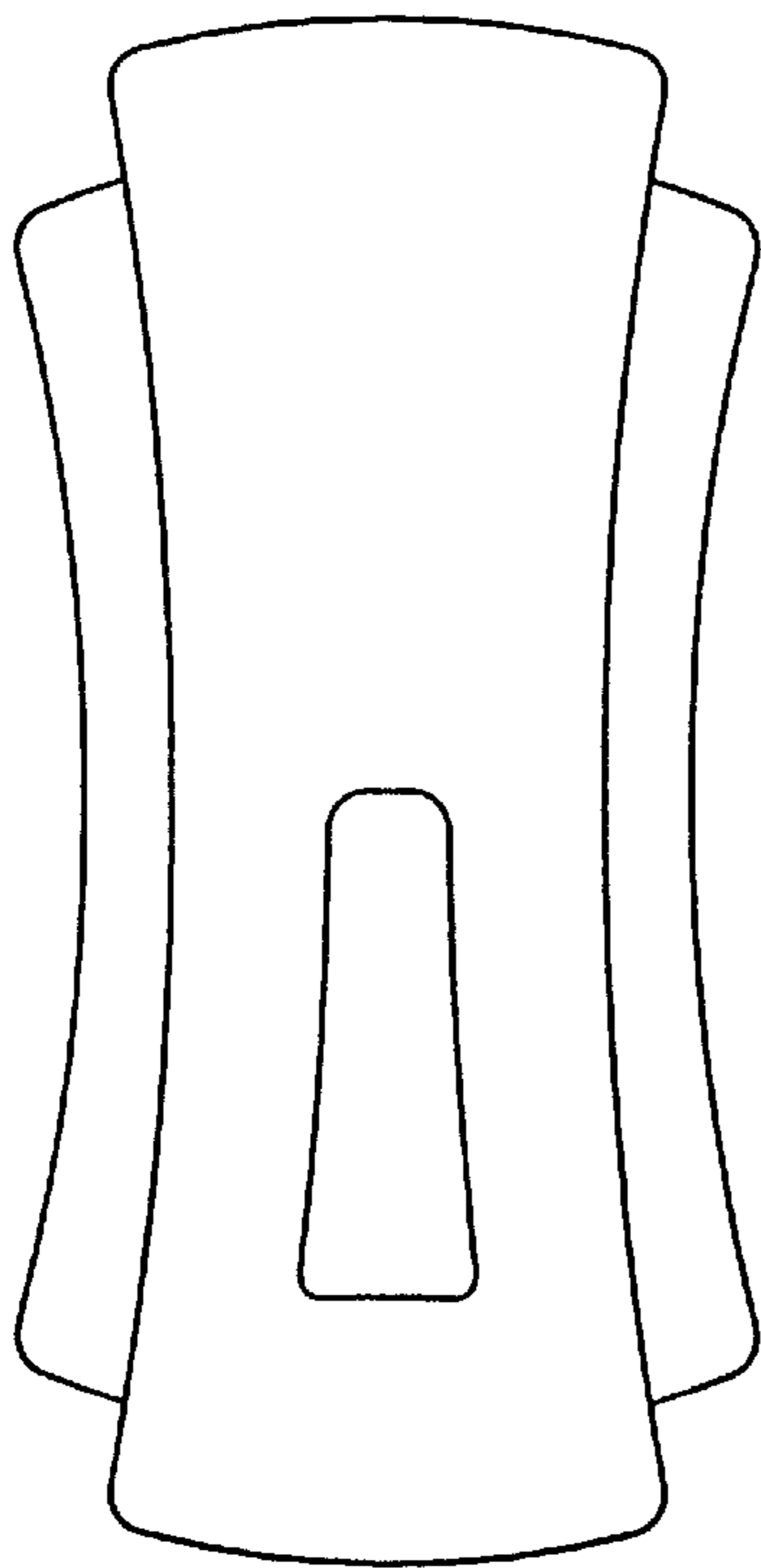

Fig. 2

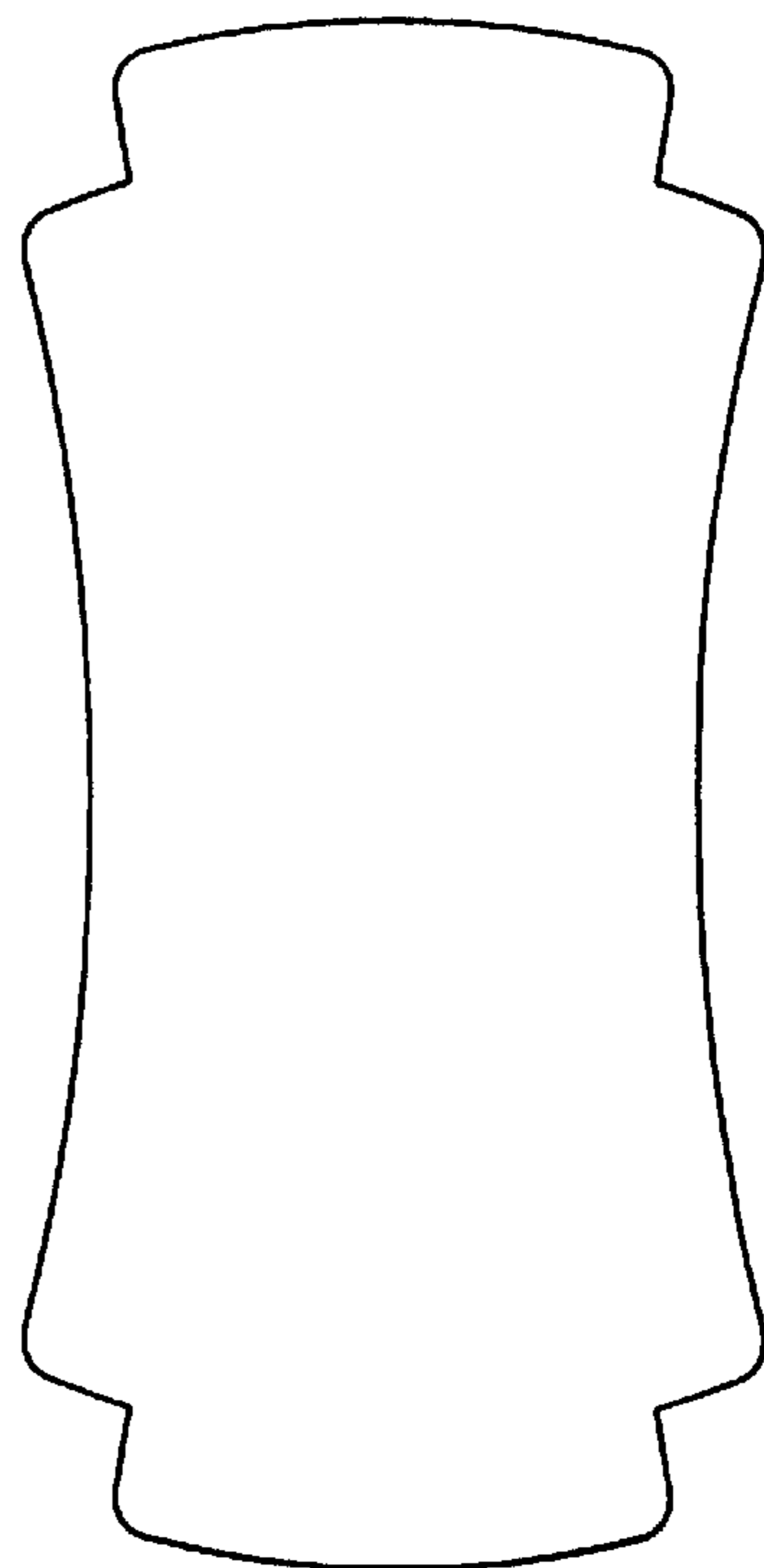

Fig. 3

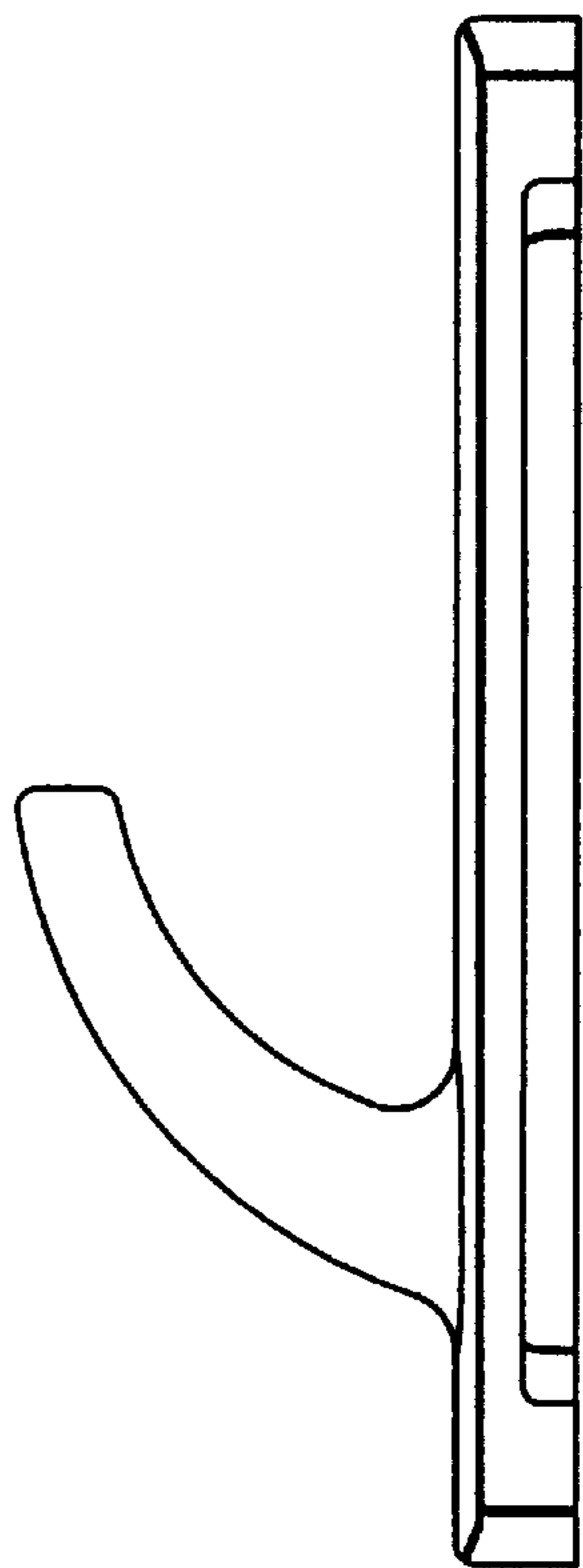

Fig. 4

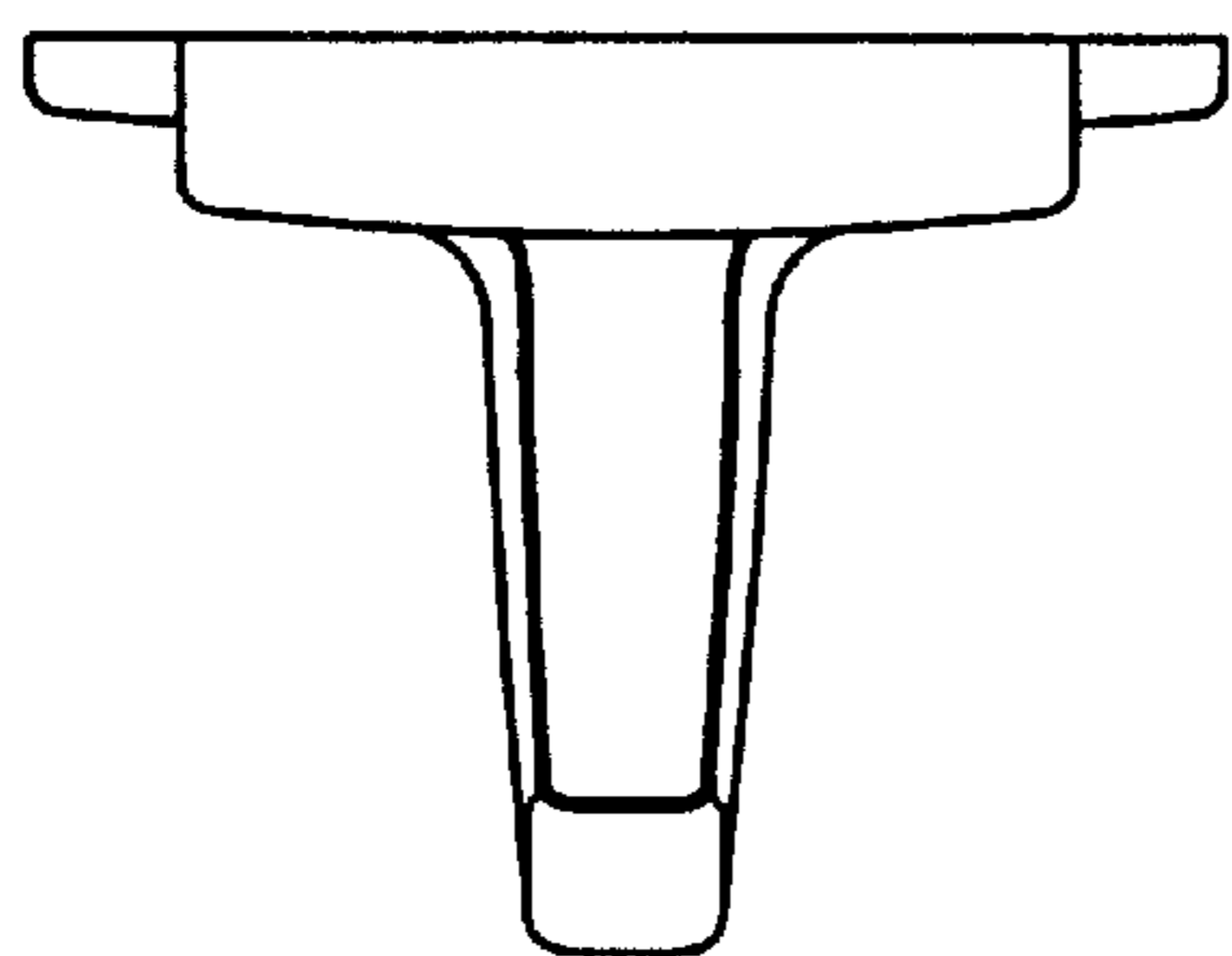

Fig. 5

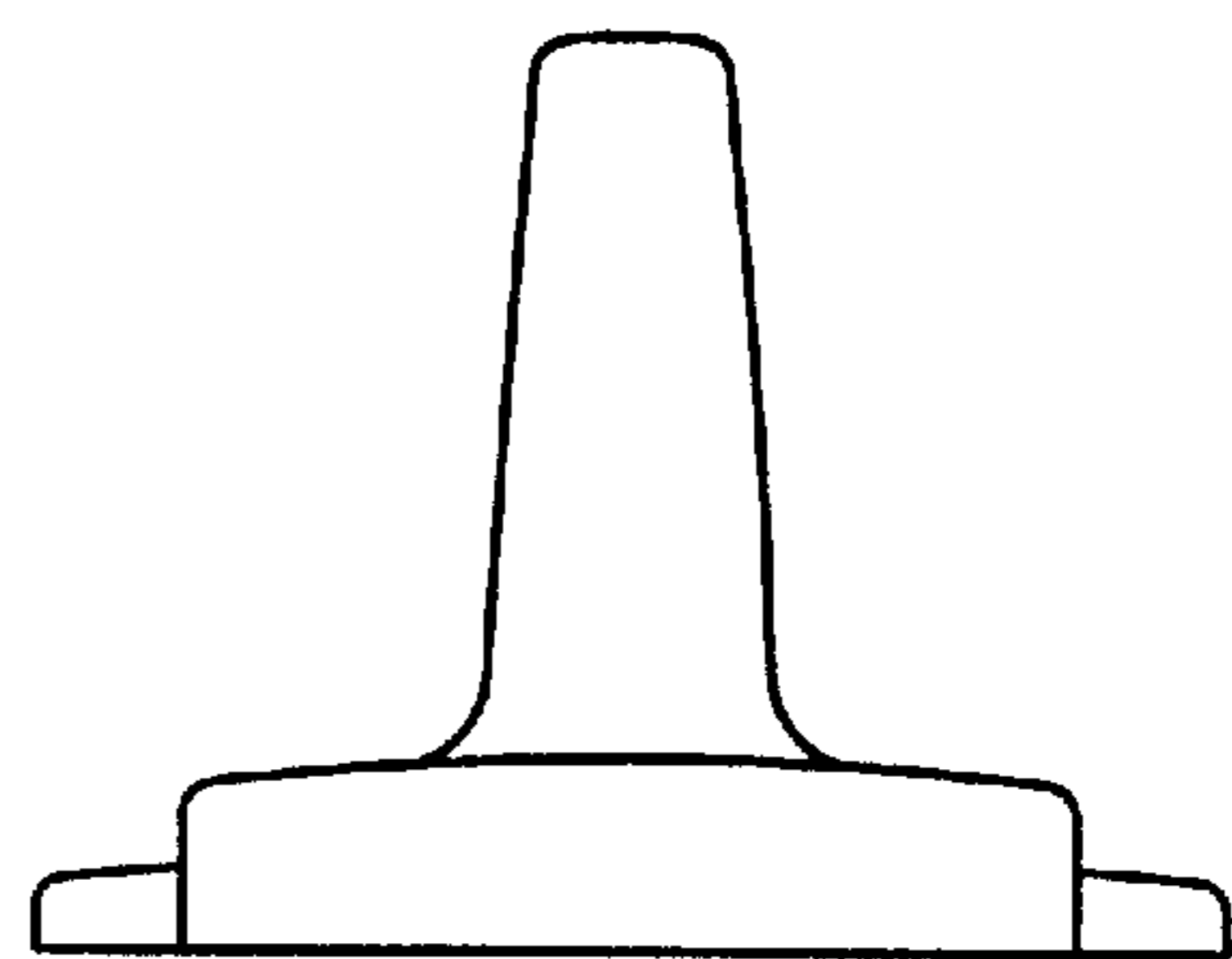

Fig. 6