



US00D417491S

United States Patent [19]

[11] **Patent Number: Des. 417,491**

Frazer et al.

[45] **Date of Patent: ** Dec. 7, 1999**

[54] **TOILET ANCHOR BOLT CAP**

5,671,904 9/1997 Minutillo 251/96

[76] Inventors: **Gary L Frazer; Ruth A Frazer**, both of 1805 Letchworth Dr., Camp Hill, Pa. 17011

Primary Examiner—Doris Clark
Assistant Examiner—Eric Watterson

[**] Term: **14 Years**

[57] **CLAIM**

The ornamental design for a toilet anchor bolt cap, as shown.

[21] Appl. No.: **29/088,592**

DESCRIPTION

[22] Filed: **May 28, 1998**

[51] **LOC (6) Cl.** **23-02**

[52] **U.S. Cl.** **D23/303**

[58] **Field of Search** D23/250–254,
D23/303–311; 4/216, 404; 251/96

FIG. 1 is a front elevational view of the toilet anchor bolt cap of the present invention;

FIG. 2 is a back elevational view of the toilet anchor bolt cap of FIG. 1;

FIG. 3 is a right side elevational view of the toilet anchor bolt cap of FIG. 1;

FIG. 4 is a left side elevational view of the toilet anchor bolt cap of FIG. 1;

FIG. 5 is a top plan view of the toilet anchor bolt cap of FIG. 1;

FIG. 6 is a bottom plan view of the toilet anchor bolt cap of FIG. 1; and,

FIG. 7 is a cross sectional view along line 7—7 of FIG. 5 of the toilet anchor bolt cap of FIG. 1.

[56] **References Cited**

U.S. PATENT DOCUMENTS

D. 304,071	10/1989	Haug et al.	D23/250
D. 323,020	1/1992	Kolada	D23/250
D. 324,807	3/1992	Reid et al.	D23/250 X
D. 358,820	5/1995	Formgren	D23/250
5,054,131	10/1991	Sim	4/216
5,390,375	2/1995	Fernstrum, Jr.	4/404

1 Claim, 4 Drawing Sheets

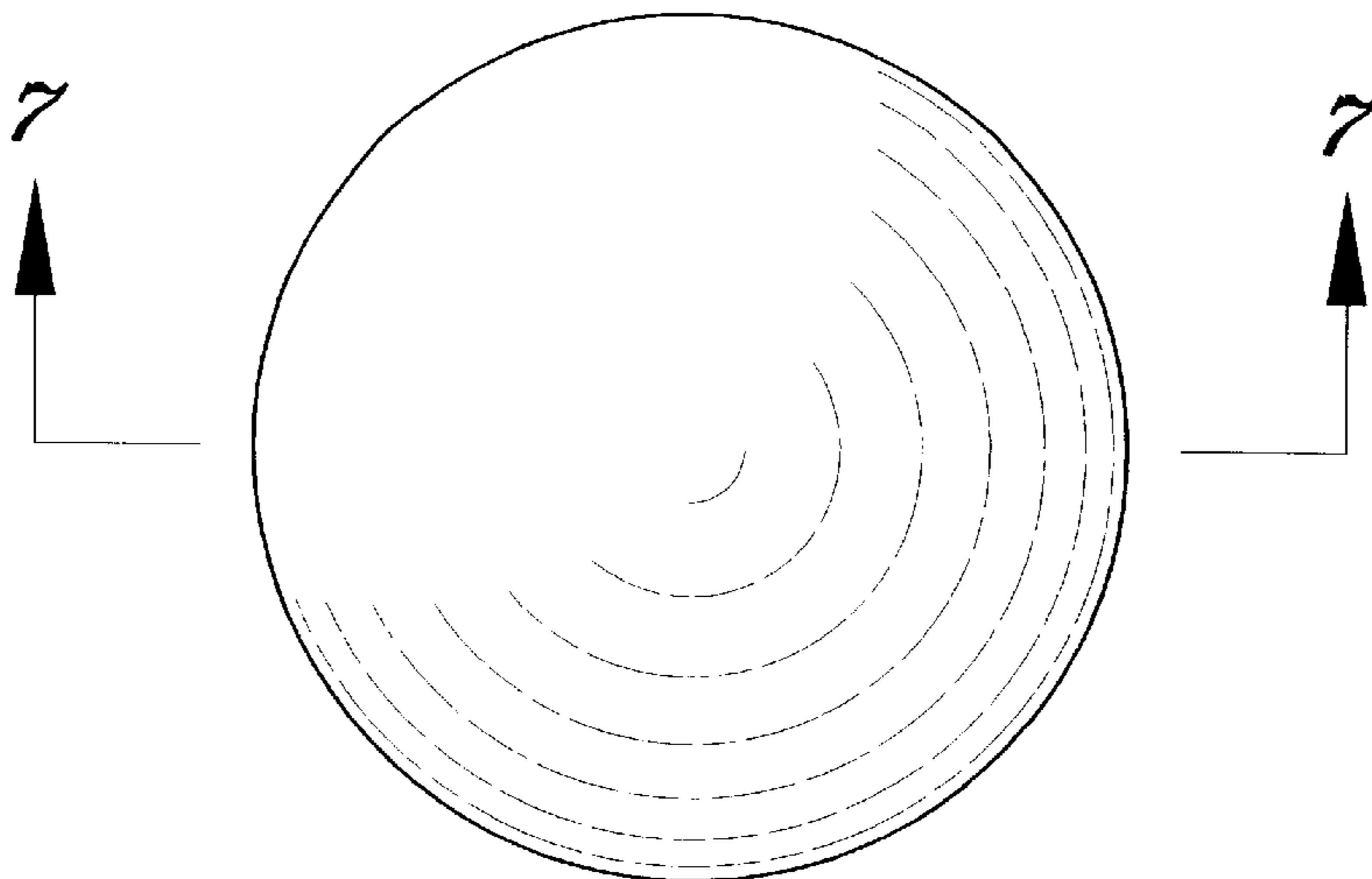
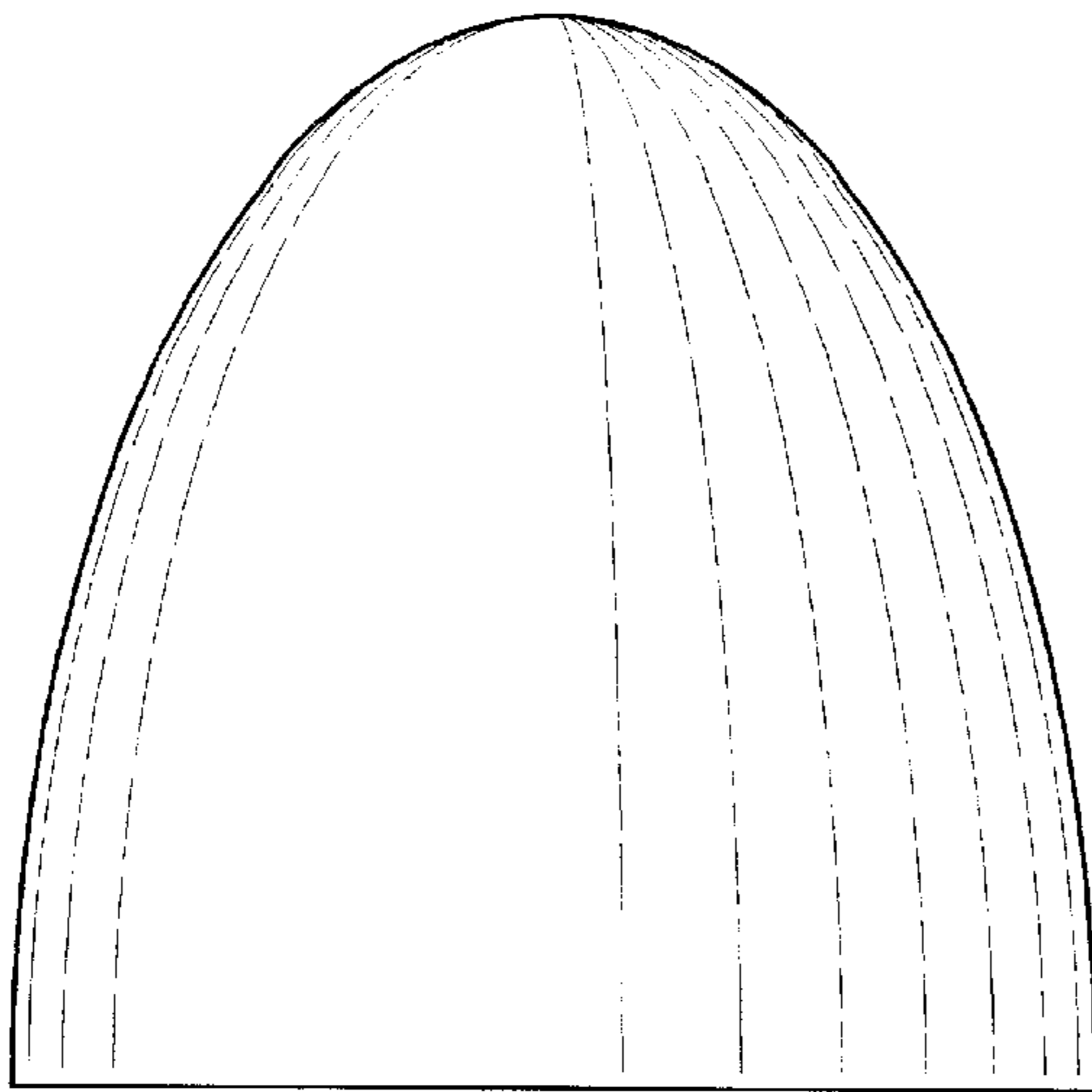

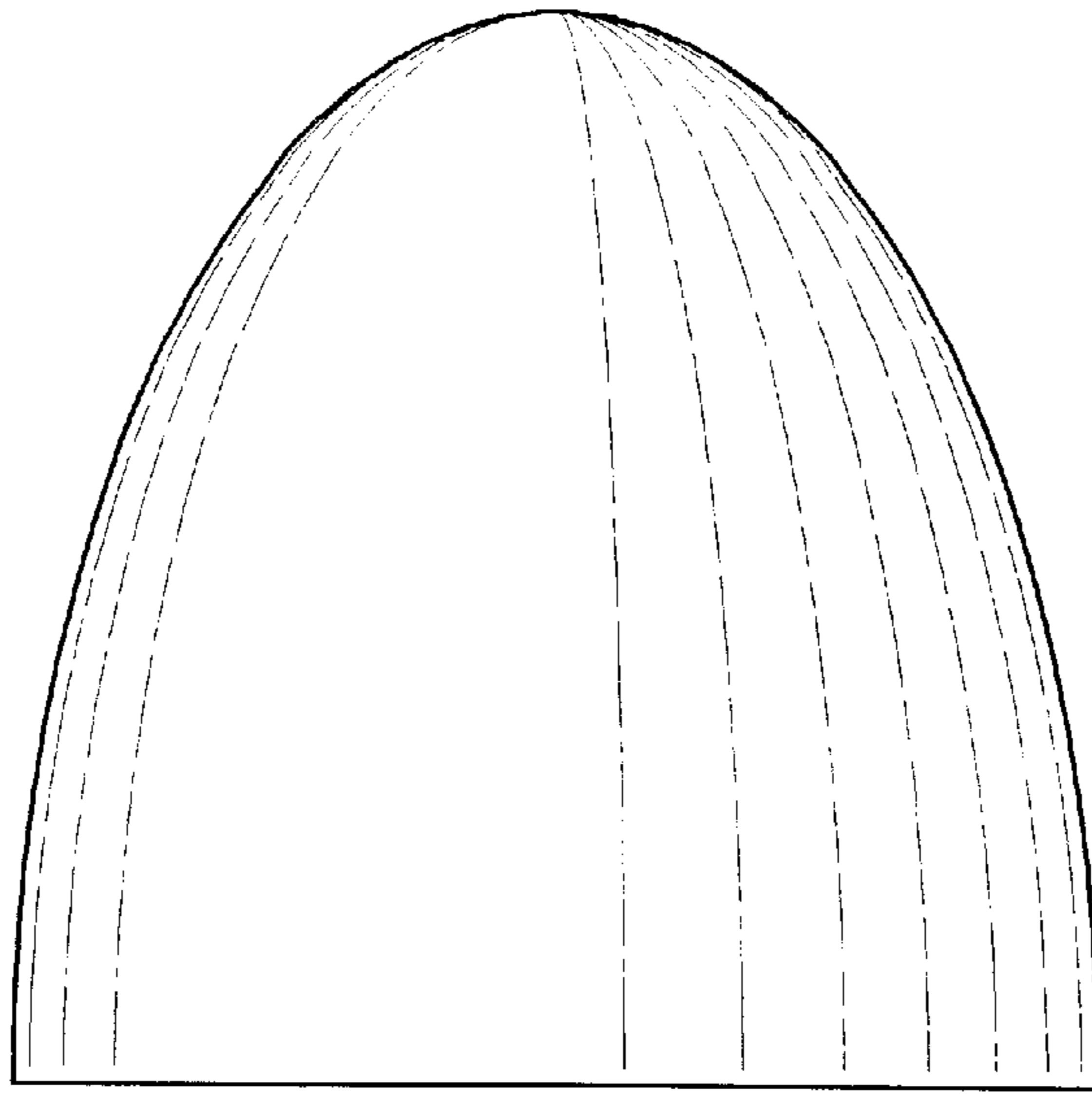

Fig. 1

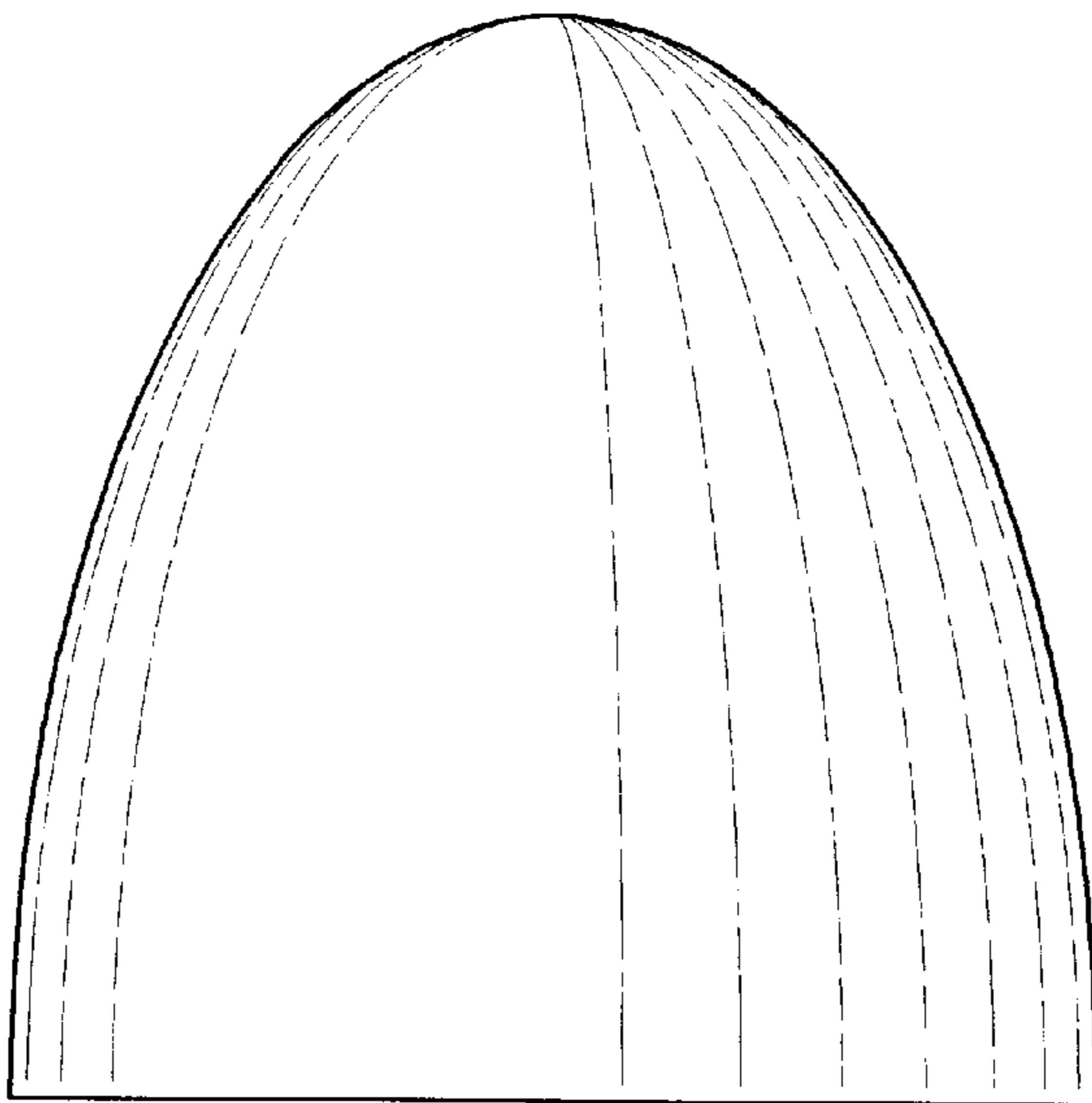

Fig. 2

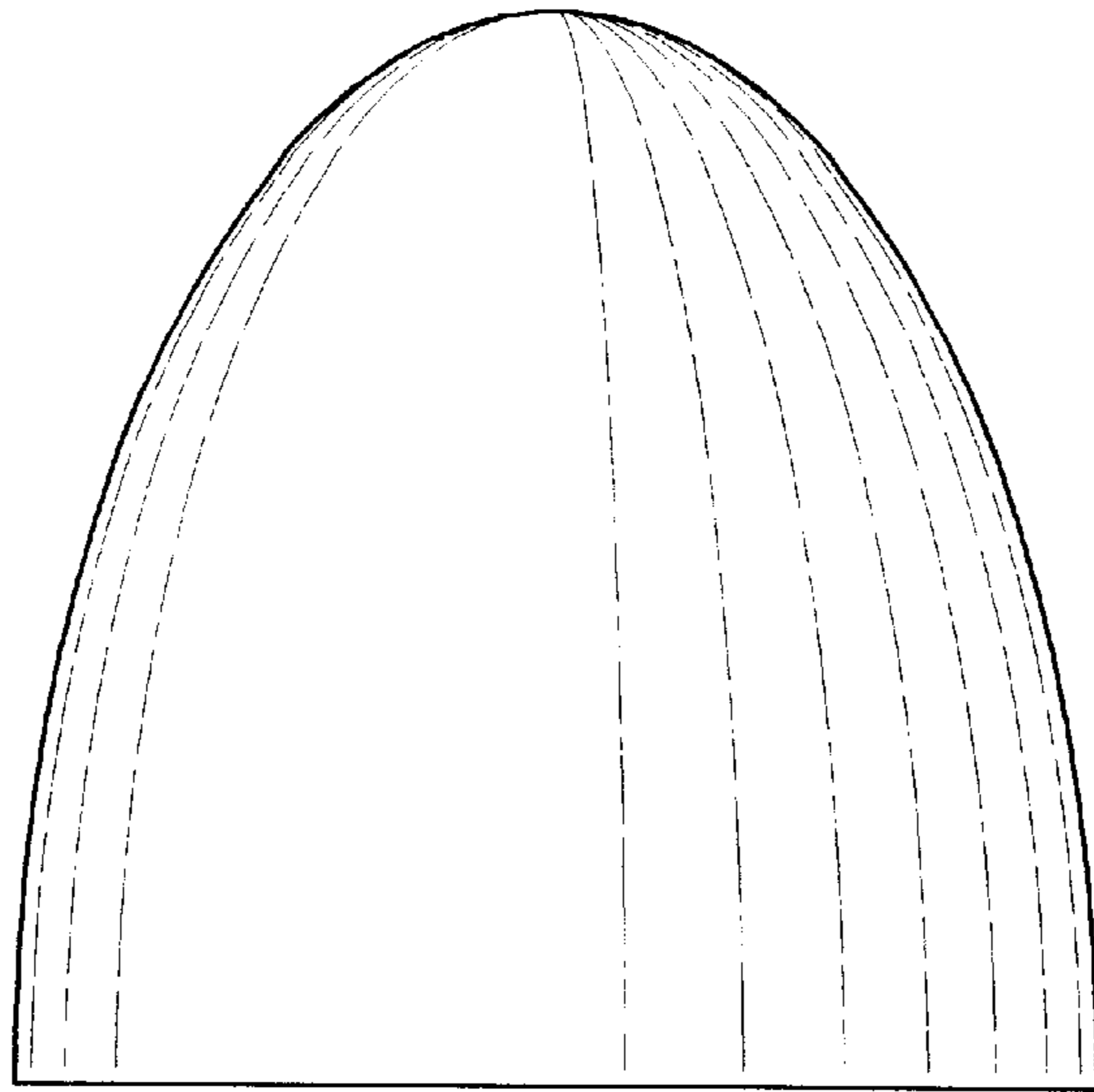

Fig. 3

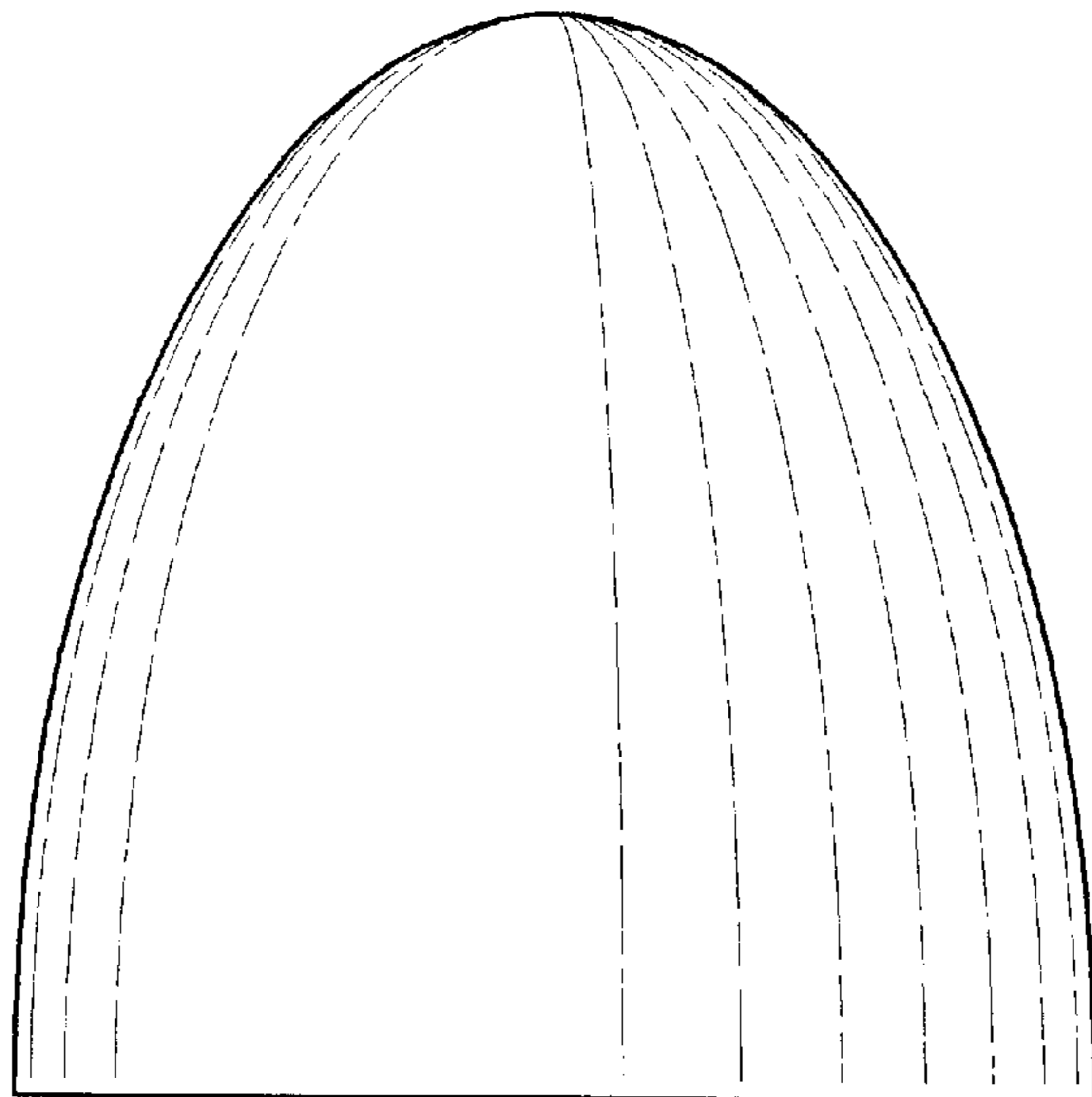

Fig. 4

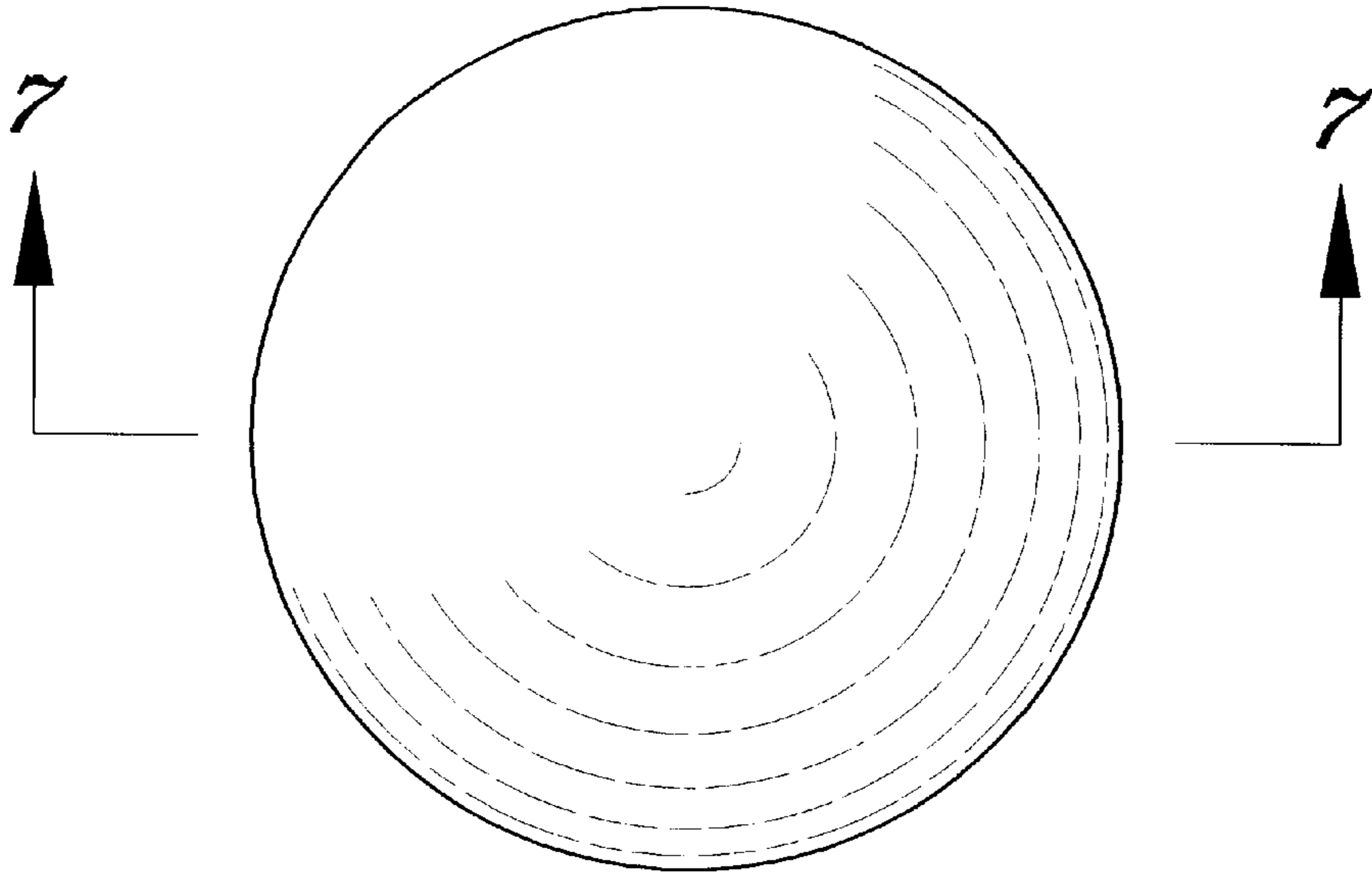

Fig. 5

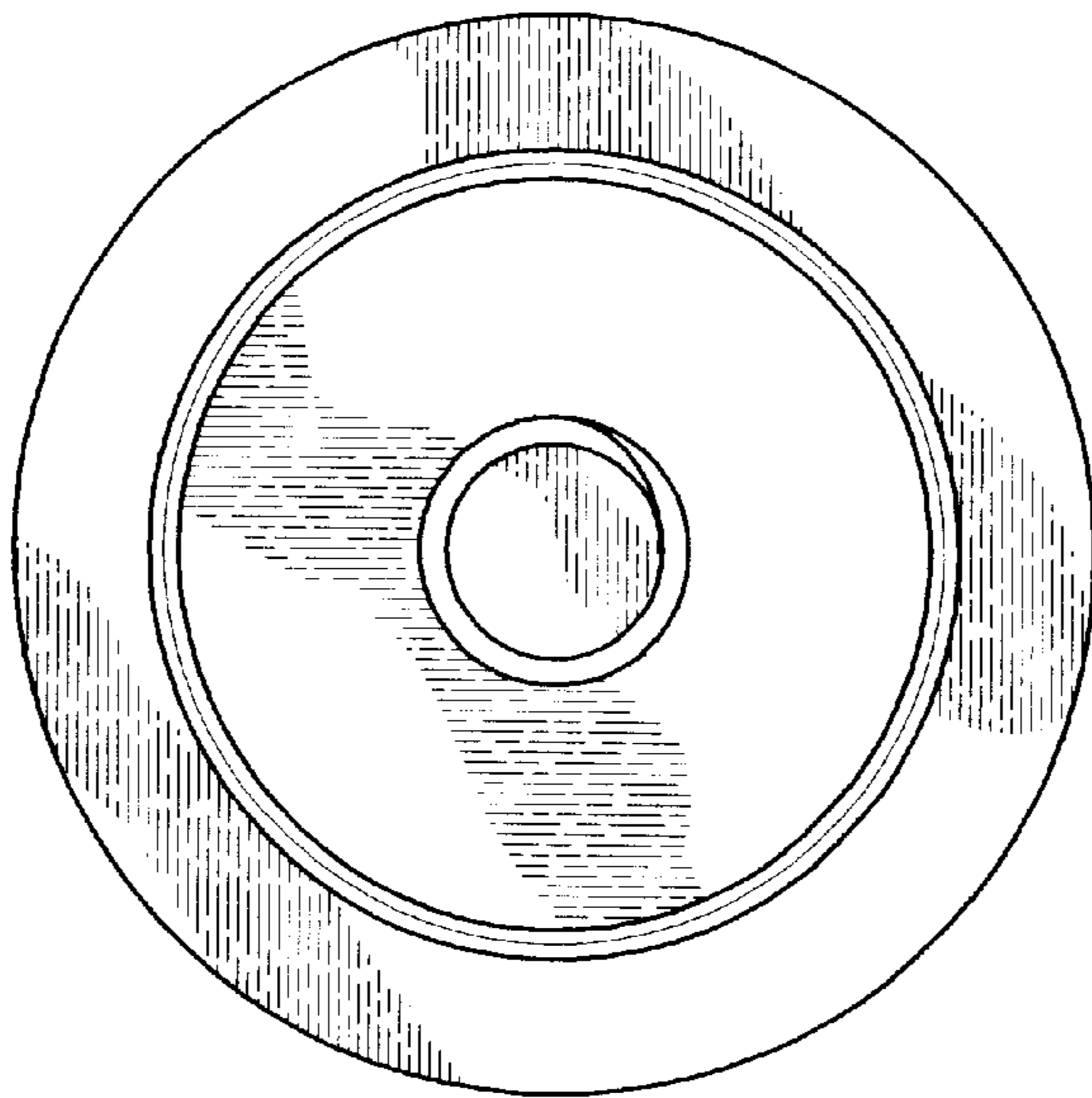

Fig. 6

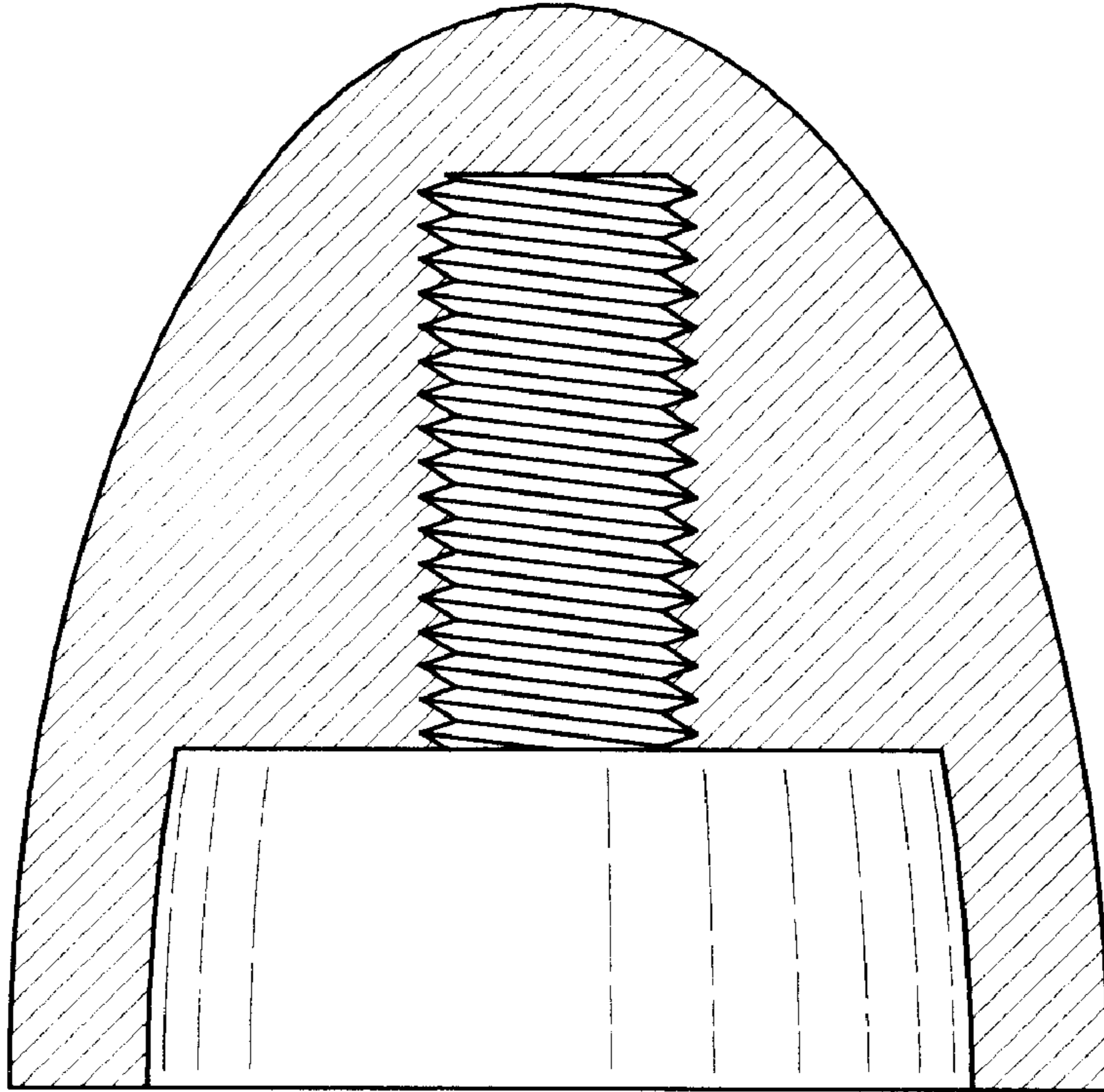

Fig. 7