



US00D417367S

United States Patent [19] Laib

[11] **Patent Number: Des. 417,367**

[45] **Date of Patent: ** Dec. 7, 1999**

[54] **BASE FOR COOKING VESSEL**

[75] Inventor: **Douglas M. Laib**, Orlando, Fla.

[73] Assignee: **Dart Industries Inc.**, Orlando, Fla.

[**] Term: **14 Years**

[21] Appl. No.: **29/074,974**

[22] Filed: **Aug. 15, 1997**

[51] **LOC (6) Cl.** **07-01**

[52] **U.S. Cl.** **D7/602; D7/360**

[58] **Field of Search** D7/500, 602, 705,
D7/545, 354, 360, 538; 99/403; 220/366,
369

[56] **References Cited**

U.S. PATENT DOCUMENTS

D. 268,557	4/1983	Jensen	D7/545
D. 288,050	2/1987	Fox et al.	D7/545
D. 296,640	7/1988	Miller	D7/545
D. 338,807	8/1993	Conti	D7/545
D. 352,423	11/1994	Laib	D7/538
D. 376,067	12/1996	Littmann	D7/360
D. 378,039	2/1997	Ferris	D7/602
D. 384,555	10/1997	Bradley	D7/545
D. 386,042	11/1997	Miller	D7/396.1
5,065,889	11/1991	Conti	220/366
5,201,264	4/1993	Thelen et al.	99/403
5,415,082	5/1995	Nagao	99/403
5,613,618	3/1997	Raoult	220/369

FOREIGN PATENT DOCUMENTS

511634 8/1939 United Kingdom .

Primary Examiner—Caron D. Veynar
Attorney, Agent, or Firm—Taylor J. Ross

[57] **CLAIM**

The ornamental design for a base for cooking vessel, as shown and described.

DESCRIPTION

FIG. 1 is a top, side and end perspective view of a base for cooking vessel showing my new design;

FIG. 2 is an end elevation view thereof, the opposite end elevation being the same;

FIG. 3 is a side elevation view thereof, the opposite side elevation being the same;

FIG. 4 is a top plan view thereof;

FIG. 5 is a bottom plan view thereof;

FIG. 6 is a top, side and end perspective view of a variation of my new design;

FIG. 7 is an end elevation view thereof, the opposite end elevation being the same;

FIG. 8 is a side elevation view thereof, the opposite side elevation being the same;

FIG. 9 is a top plan view thereof;

FIG. 10 is a bottom plan view thereof;

FIG. 11 is a top, side and end perspective view of a second variation of my new design;

FIG. 12 is an end elevation view thereof, the opposite end elevation being the same;

FIG. 13 is a side elevational view thereof, the opposite side elevation being the same;

FIG. 14 is a top plan view thereof;

FIG. 15 is a bottom plan view thereof;

FIG. 16 is a top, side and end perspective view of a third variation of my new design;

FIG. 17 is an end elevation view thereof, the opposite end elevation being the same;

FIG. 18 is a side elevation view thereof, the opposite side elevation being the same;

FIG. 19 is a top plan view thereof; and,

FIG. 20 is a bottom plan view thereof.

1 Claim, 8 Drawing Sheets

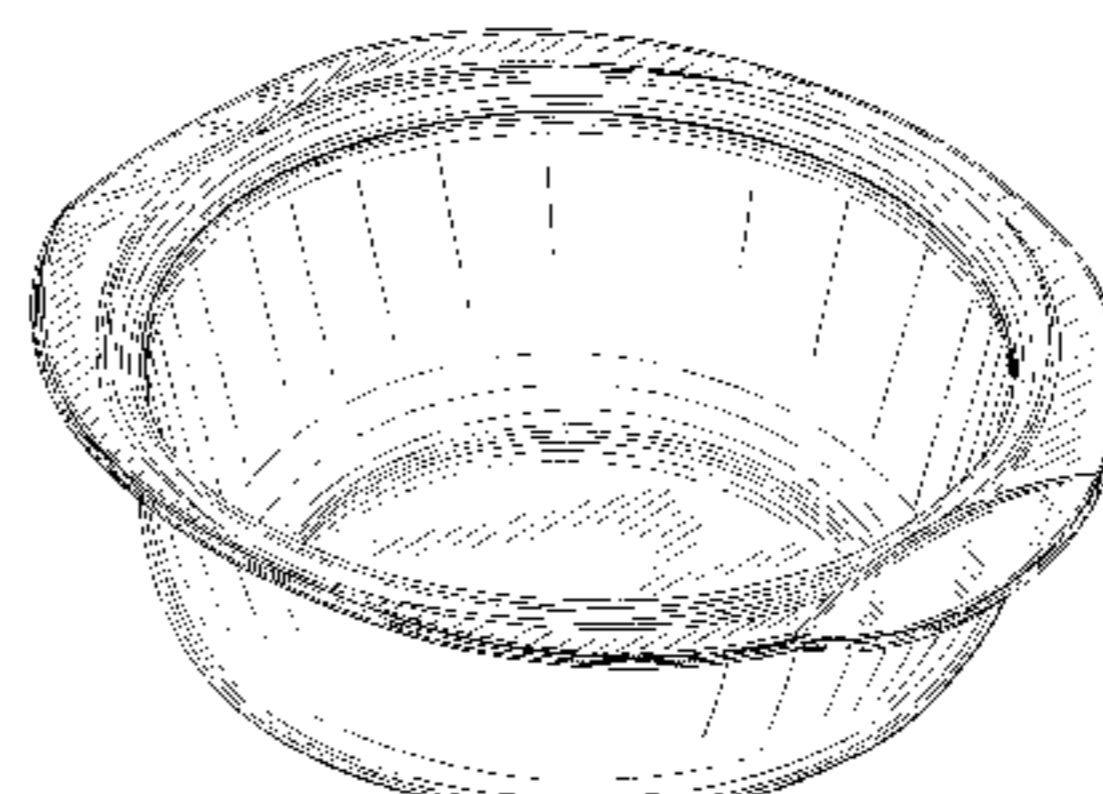
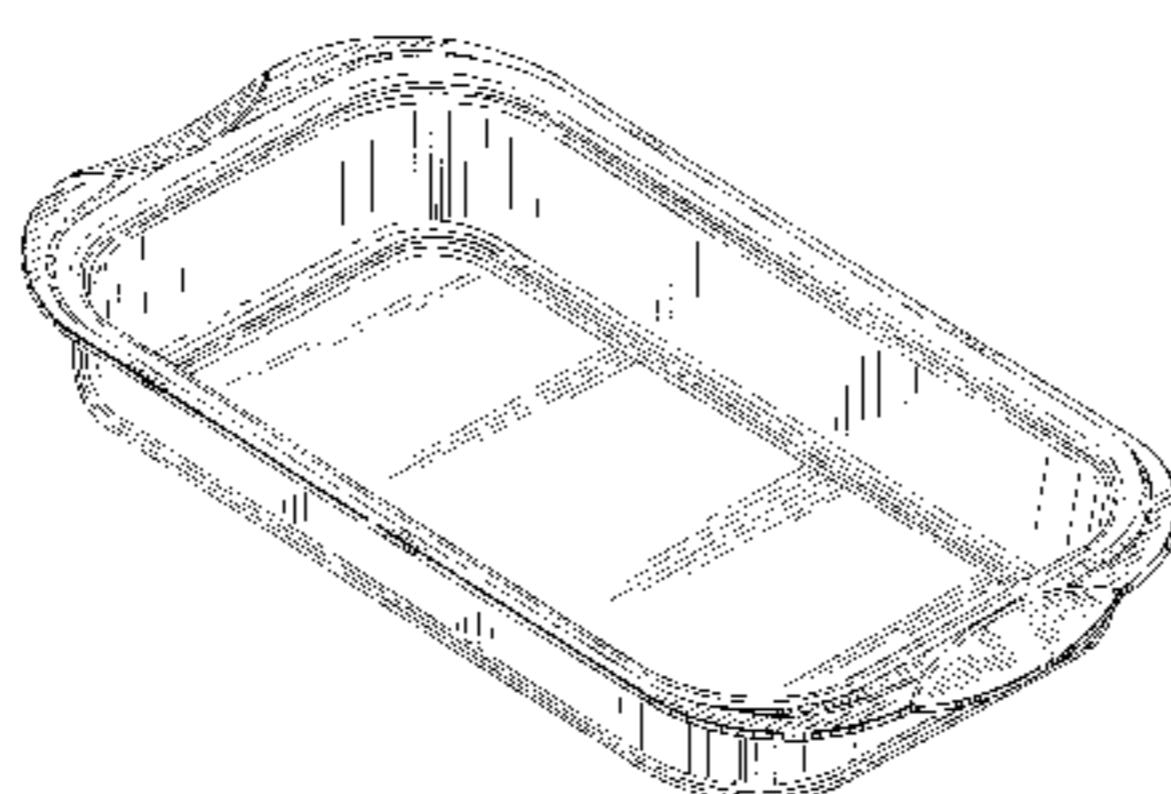
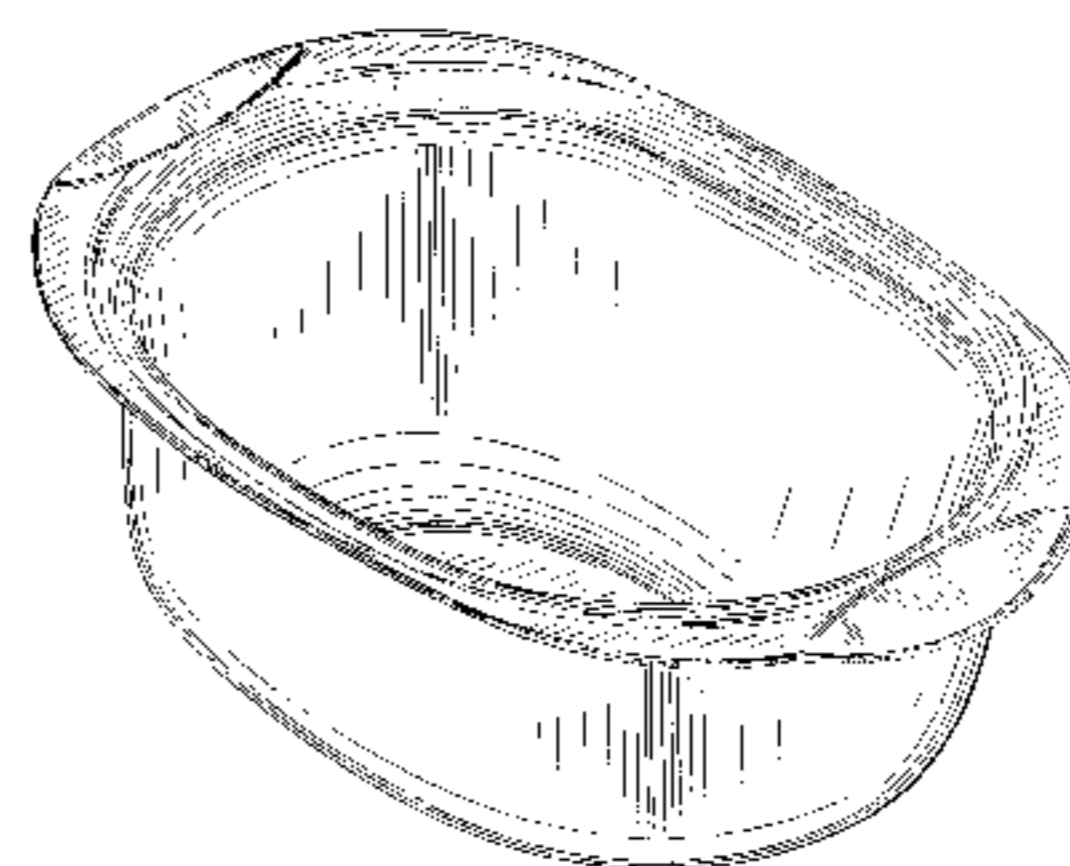
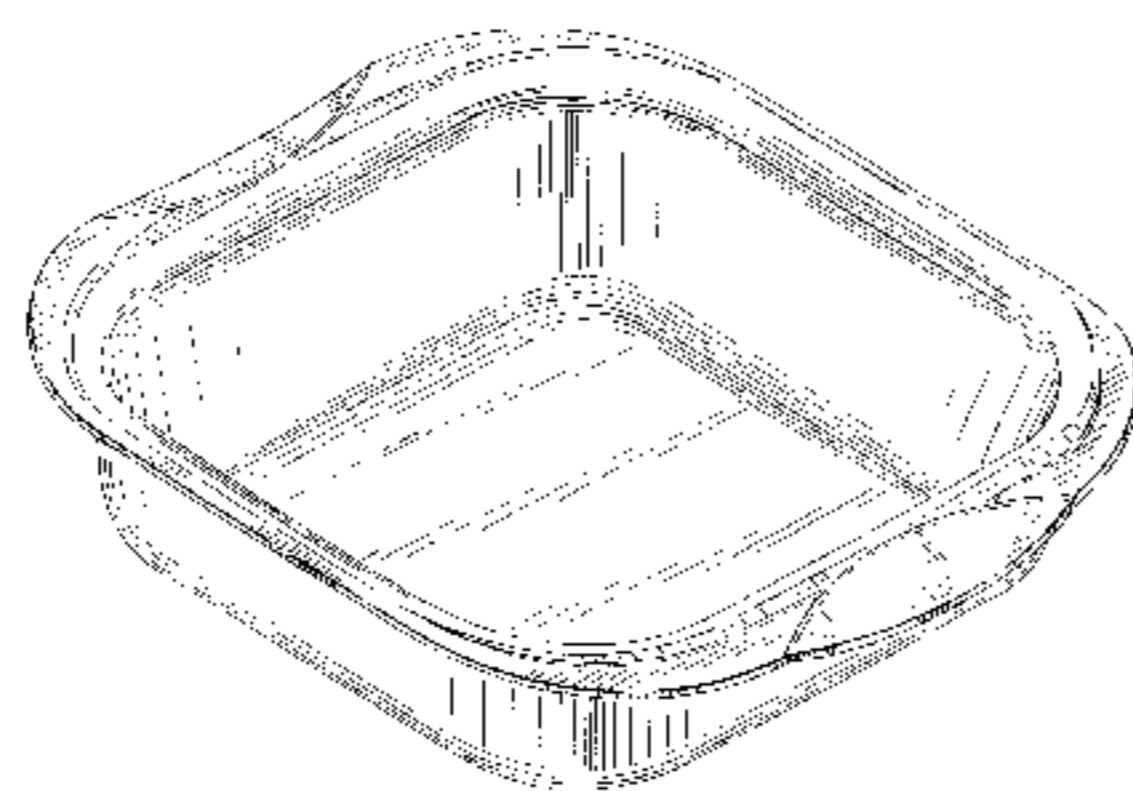

FIG. 1

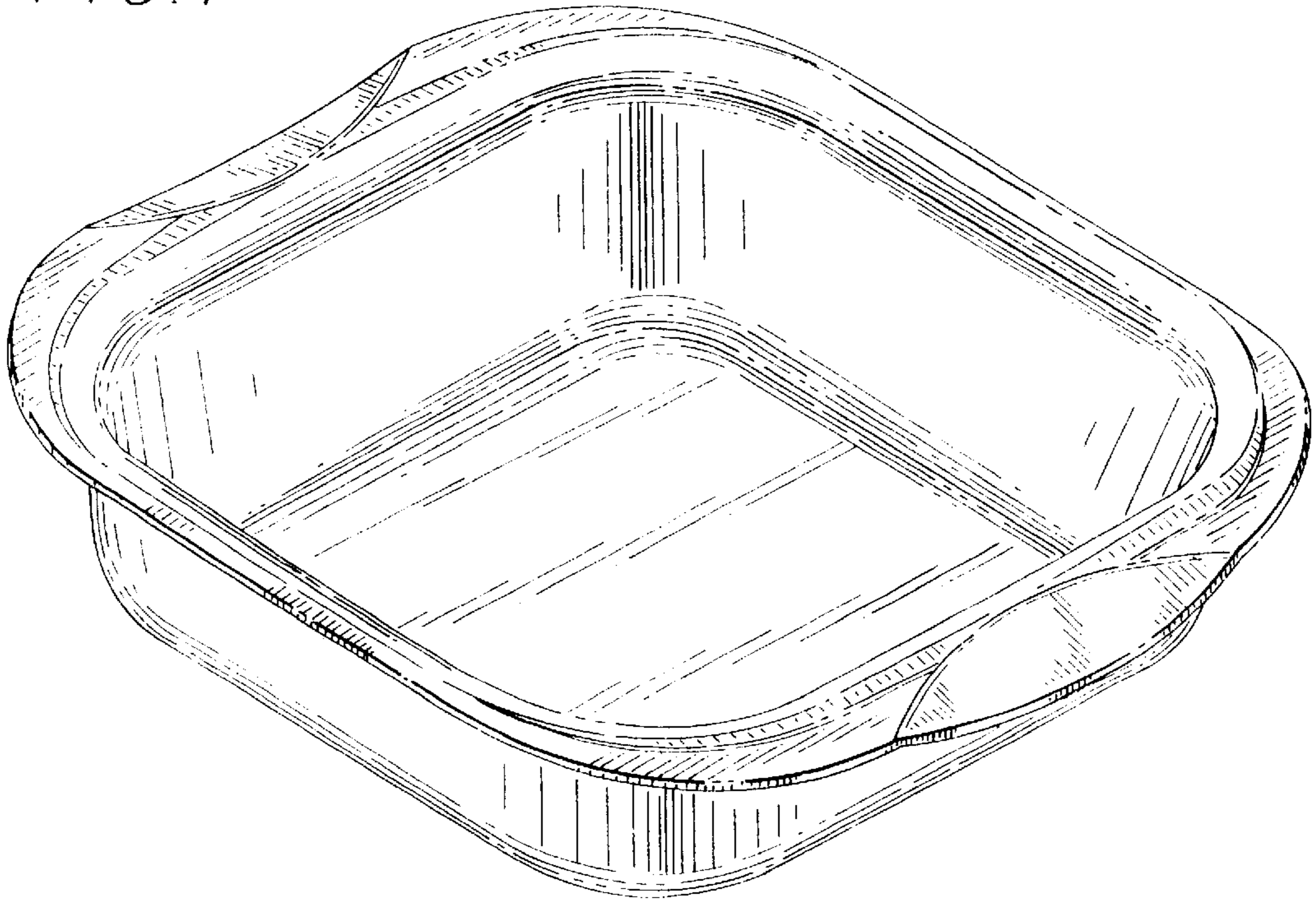

FIG. 2

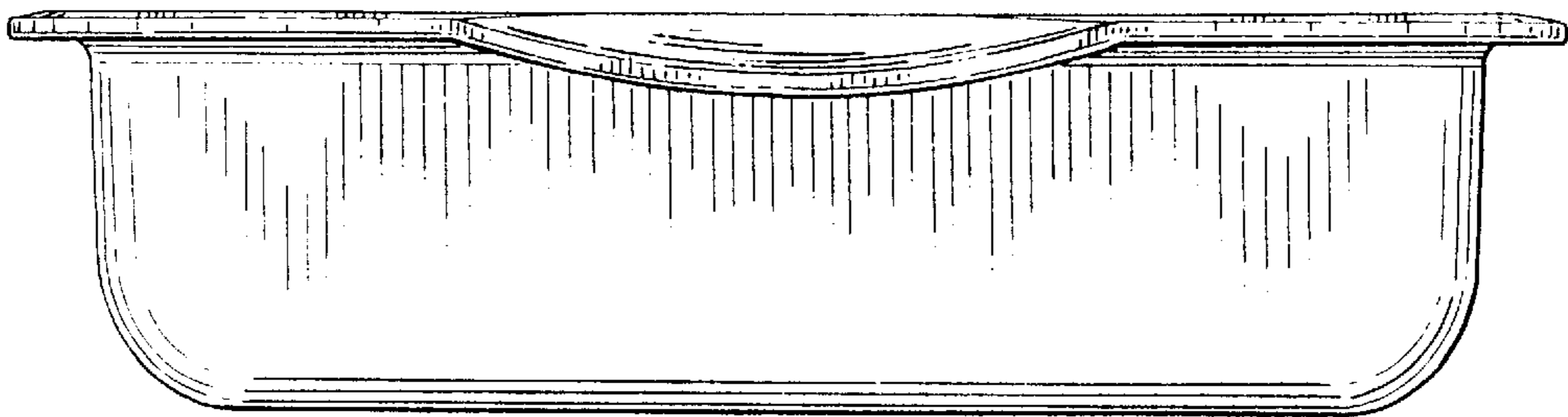

FIG. 3

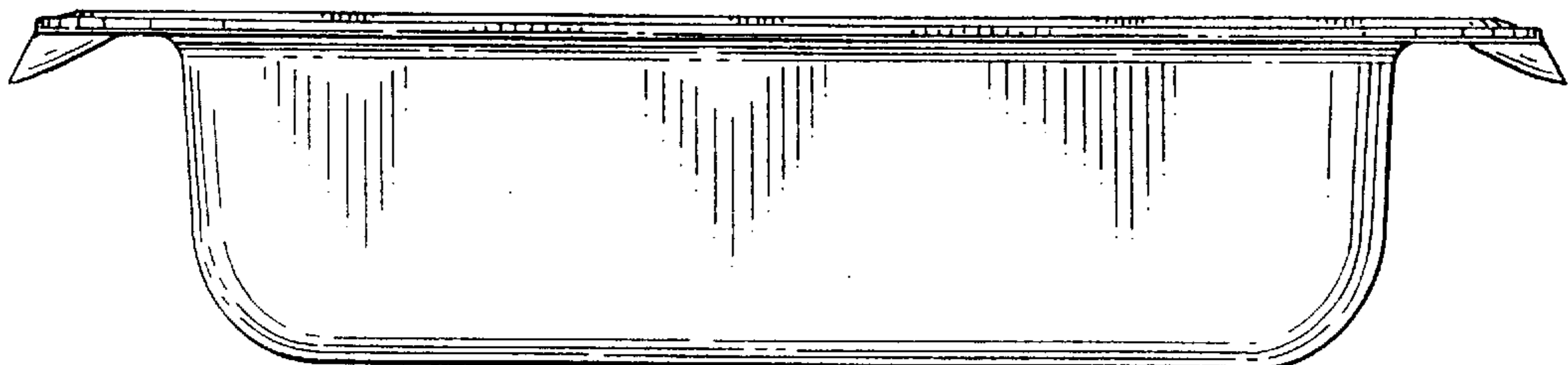

FIG. 4

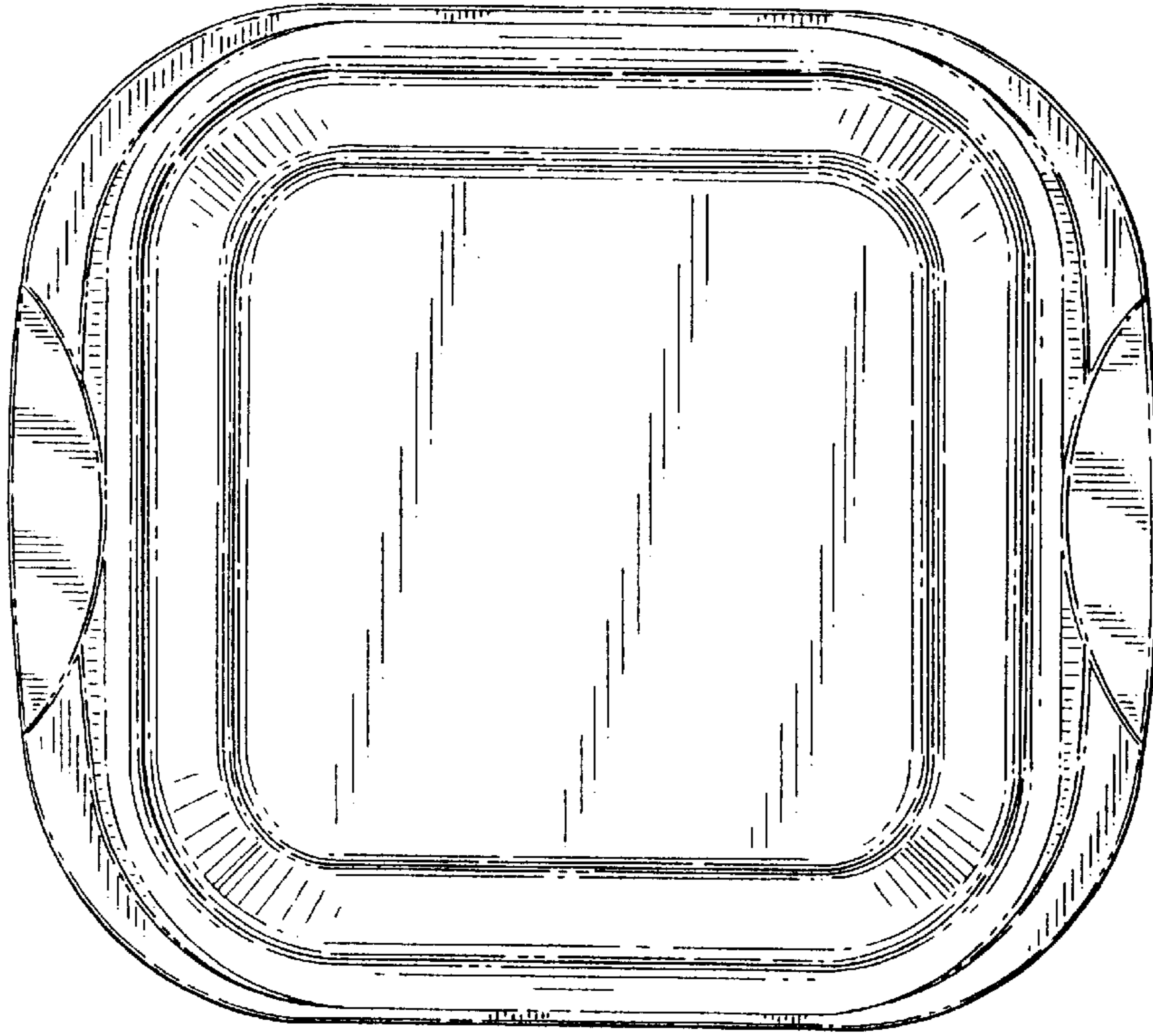
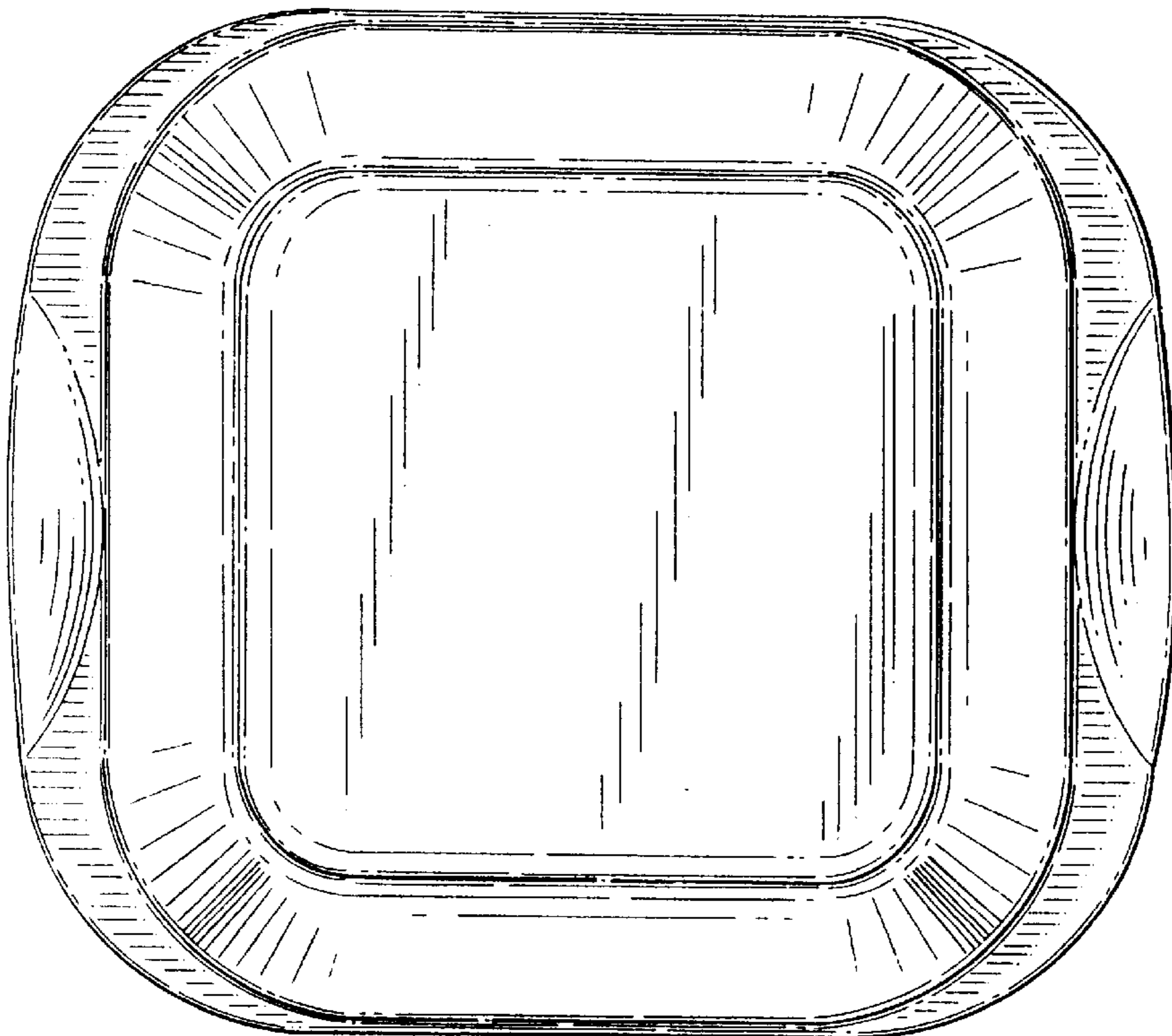

FIG. 5



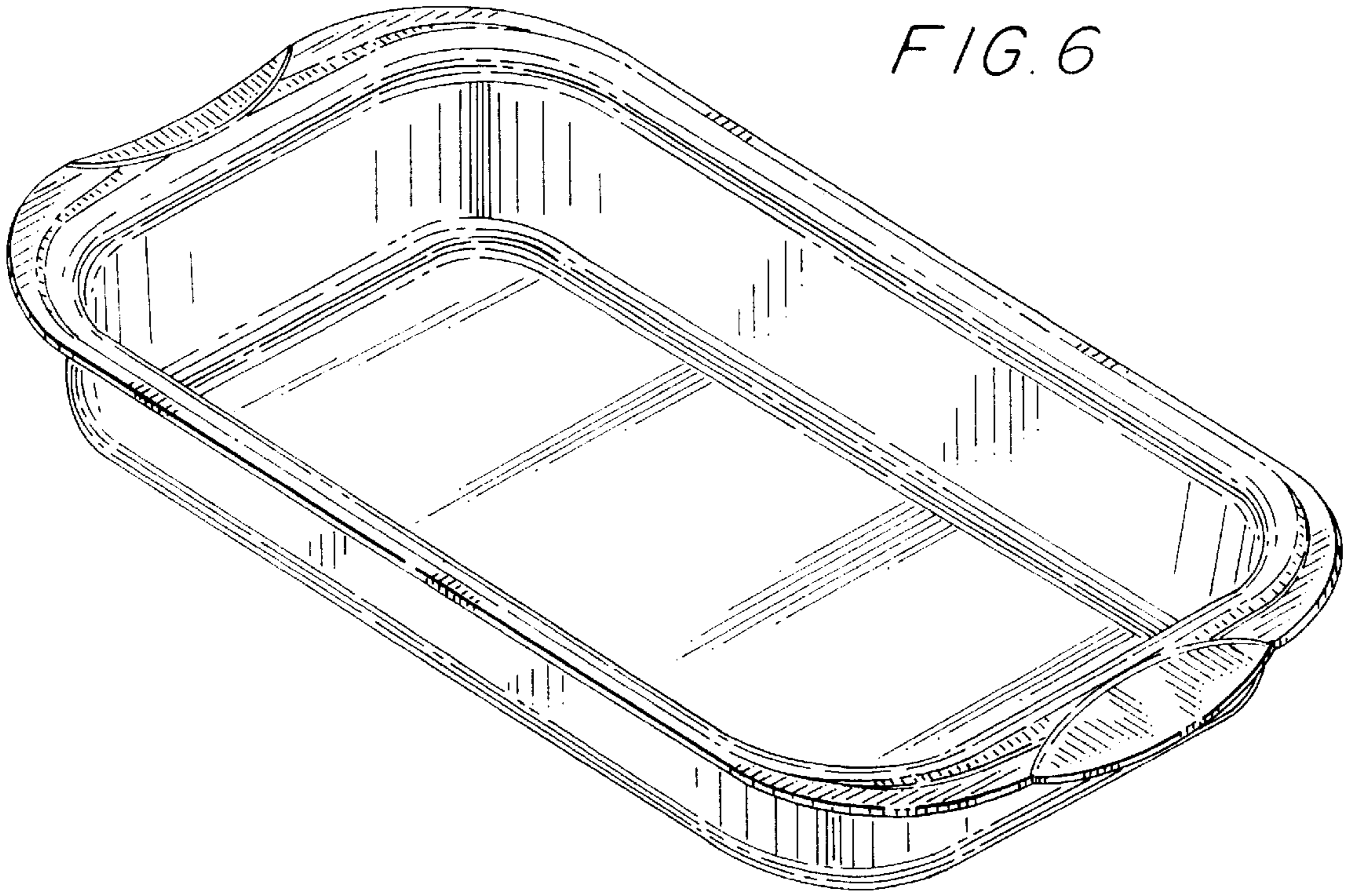

FIG. 6

FIG. 7

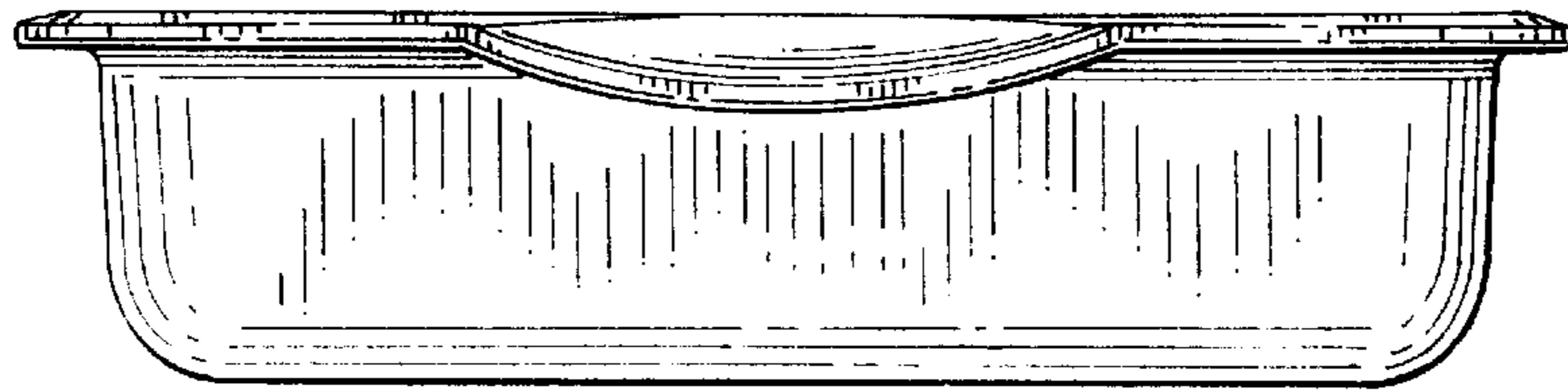

FIG. 8

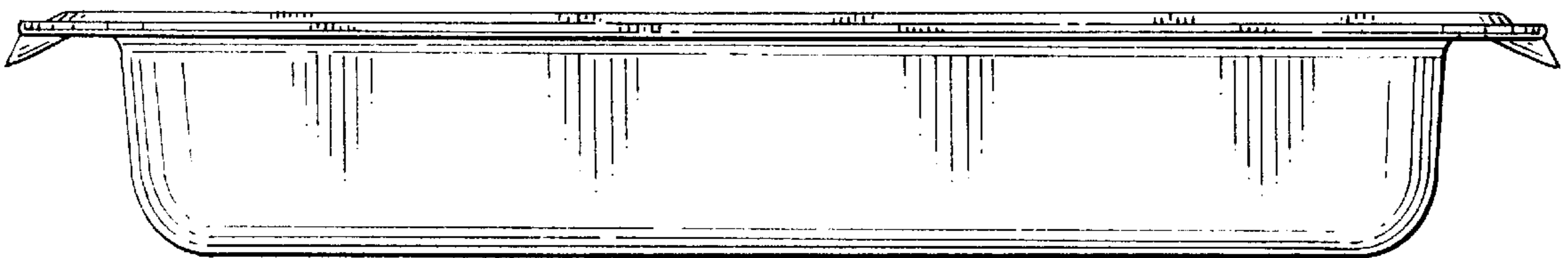

FIG. 9

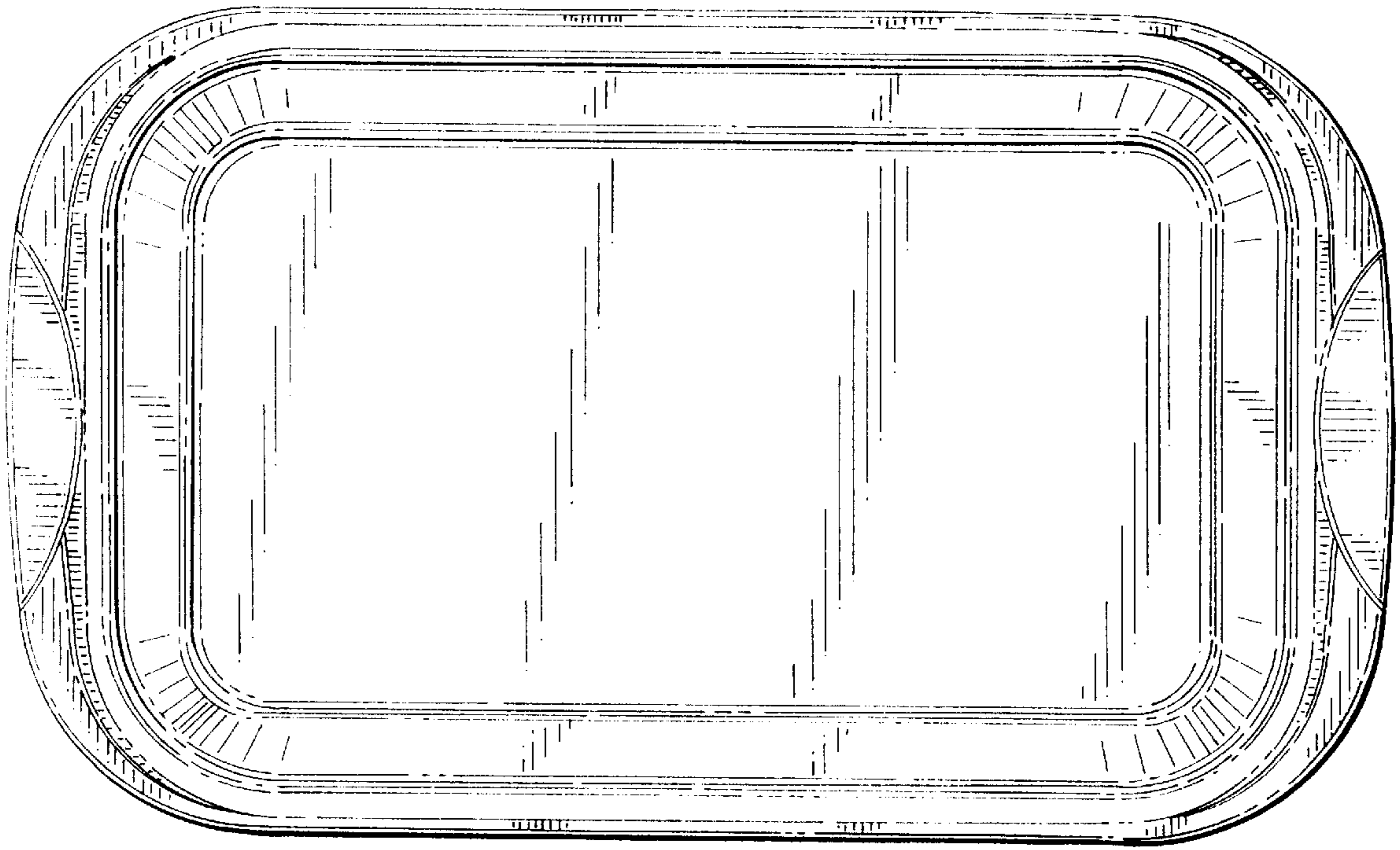
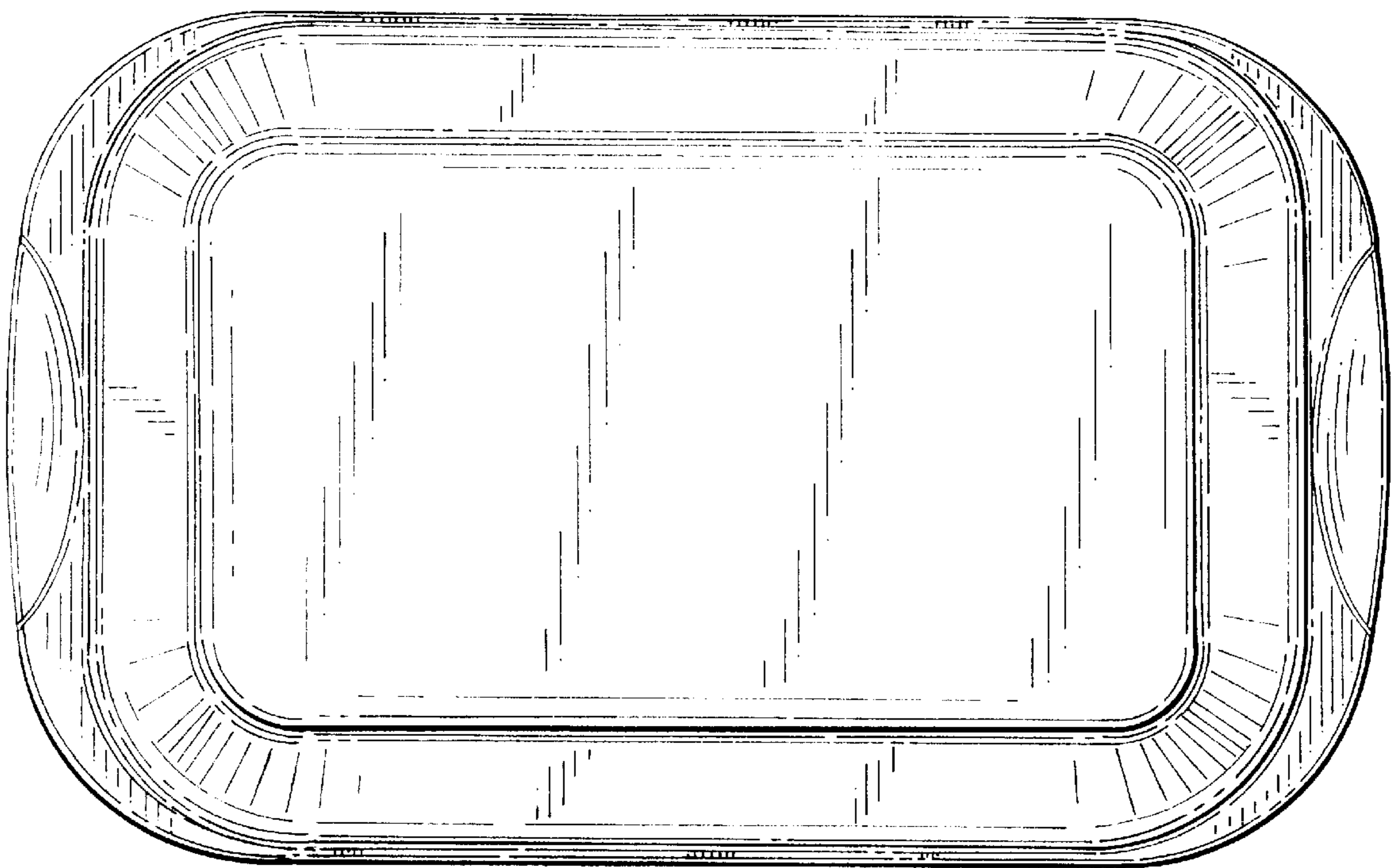

FIG. 10



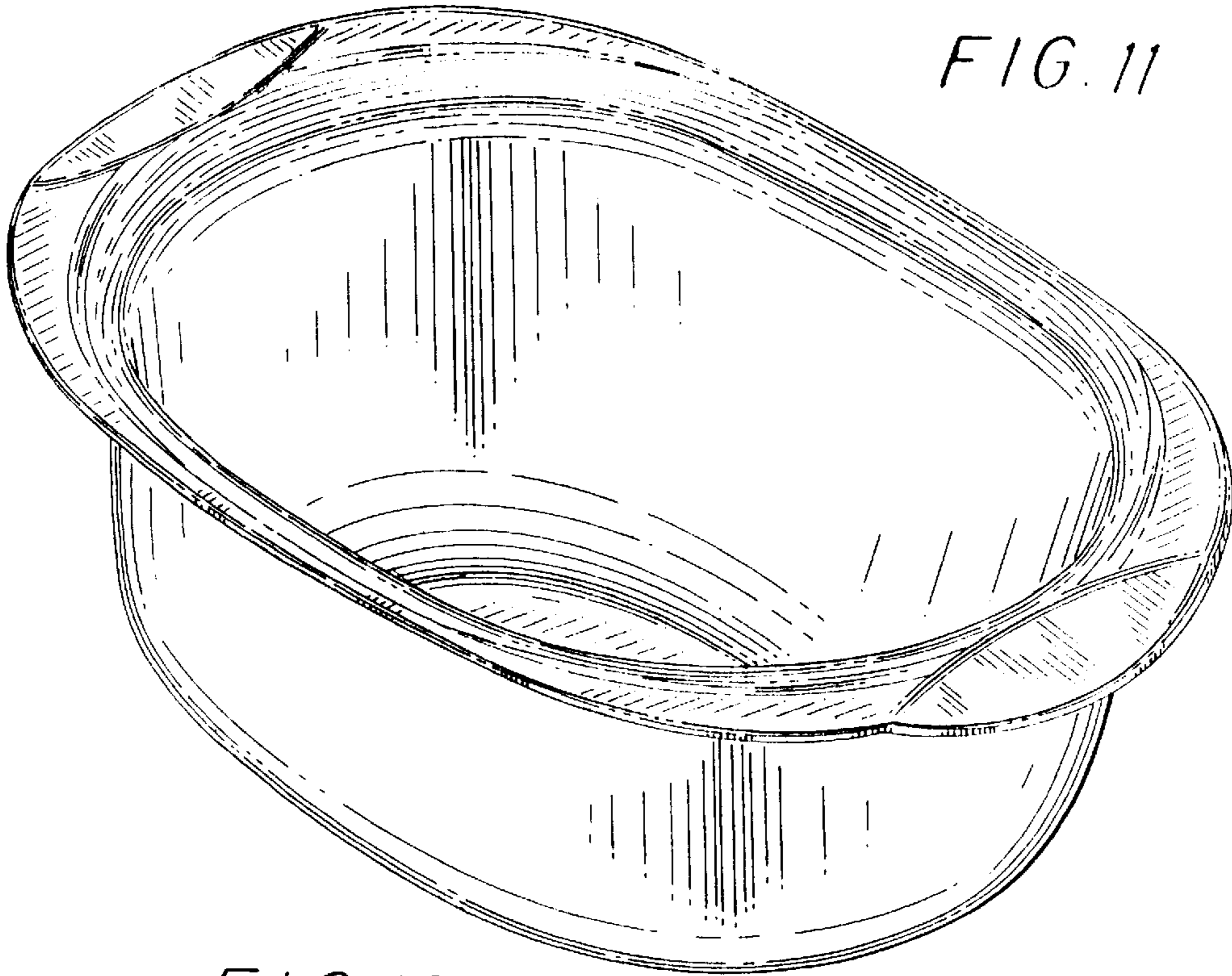

FIG. 11

FIG. 12

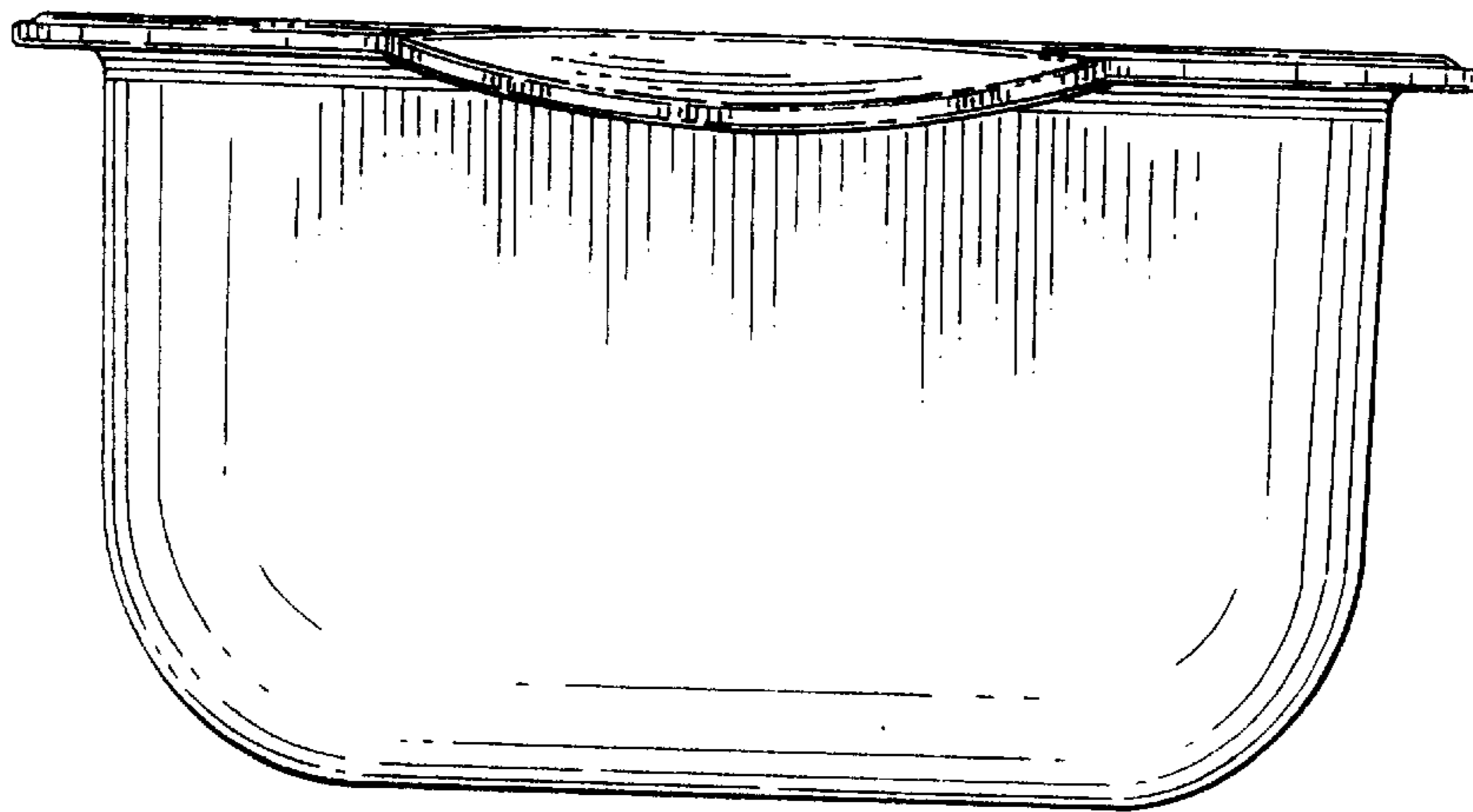

FIG. 13

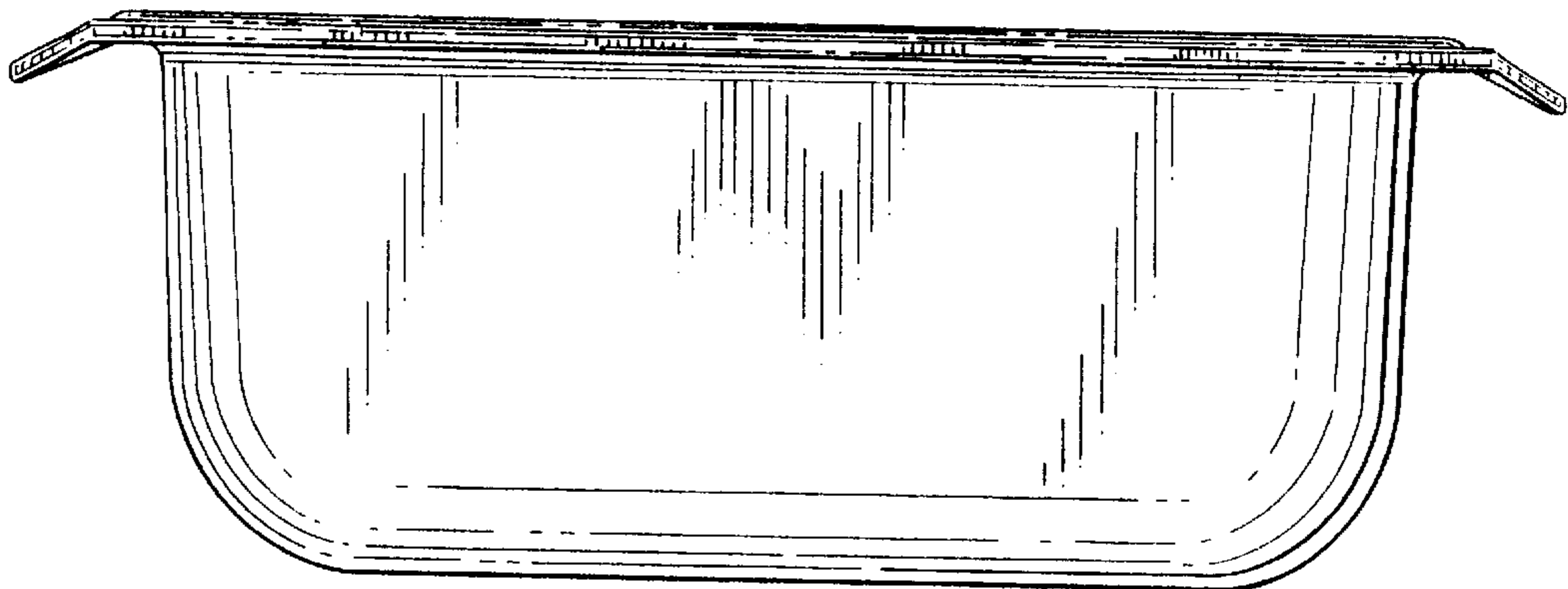

FIG. 14

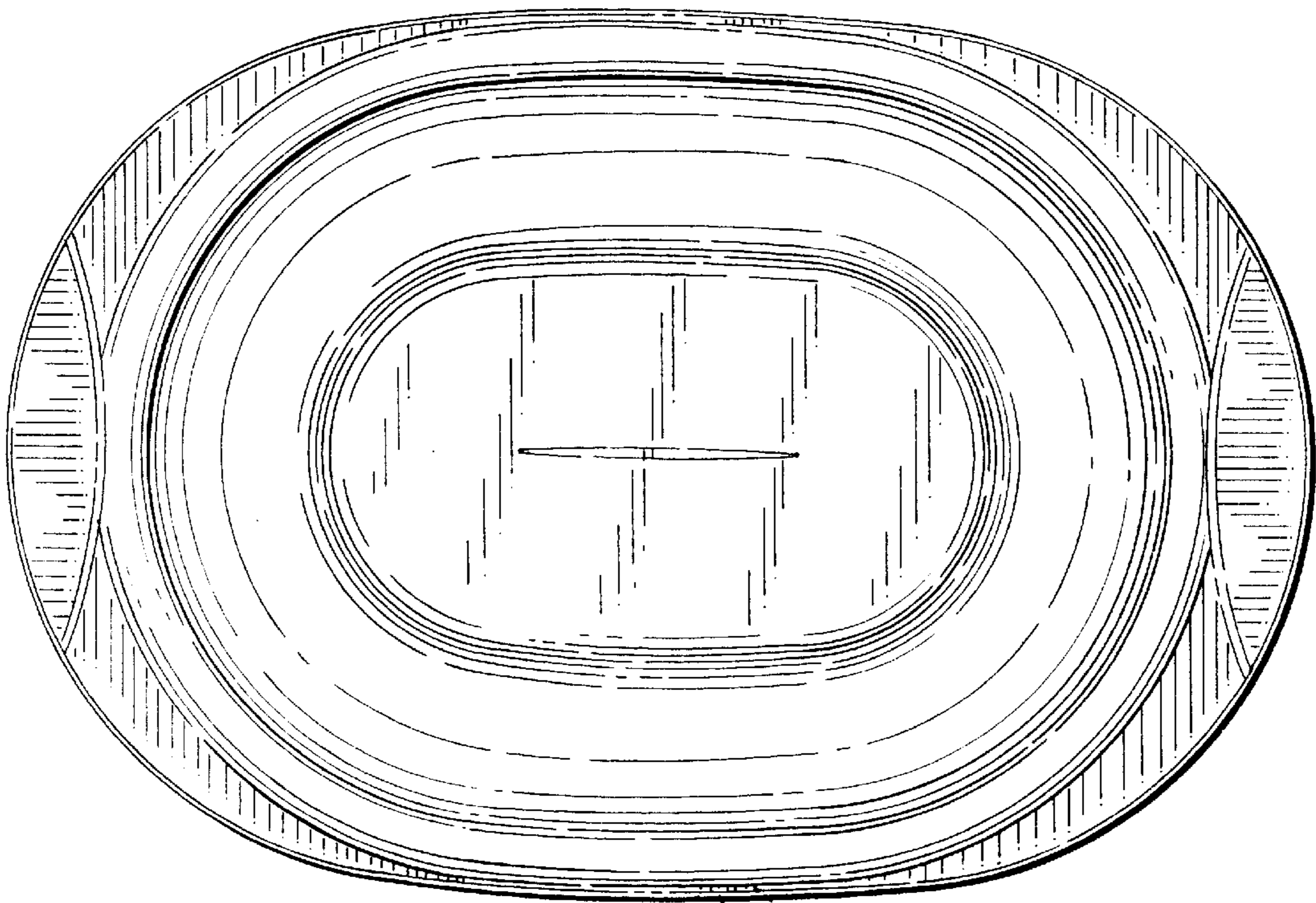

FIG. 15

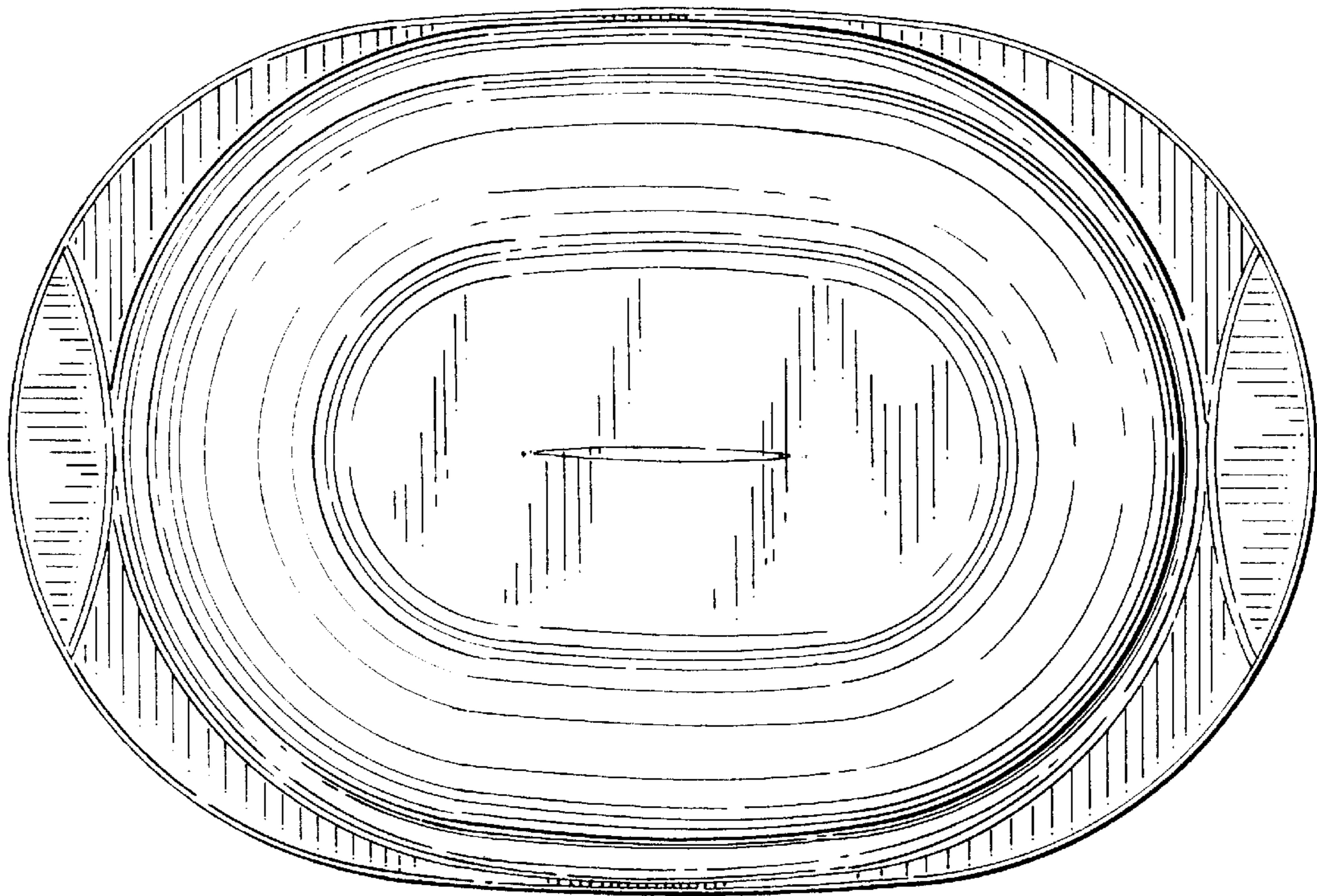

FIG. 16

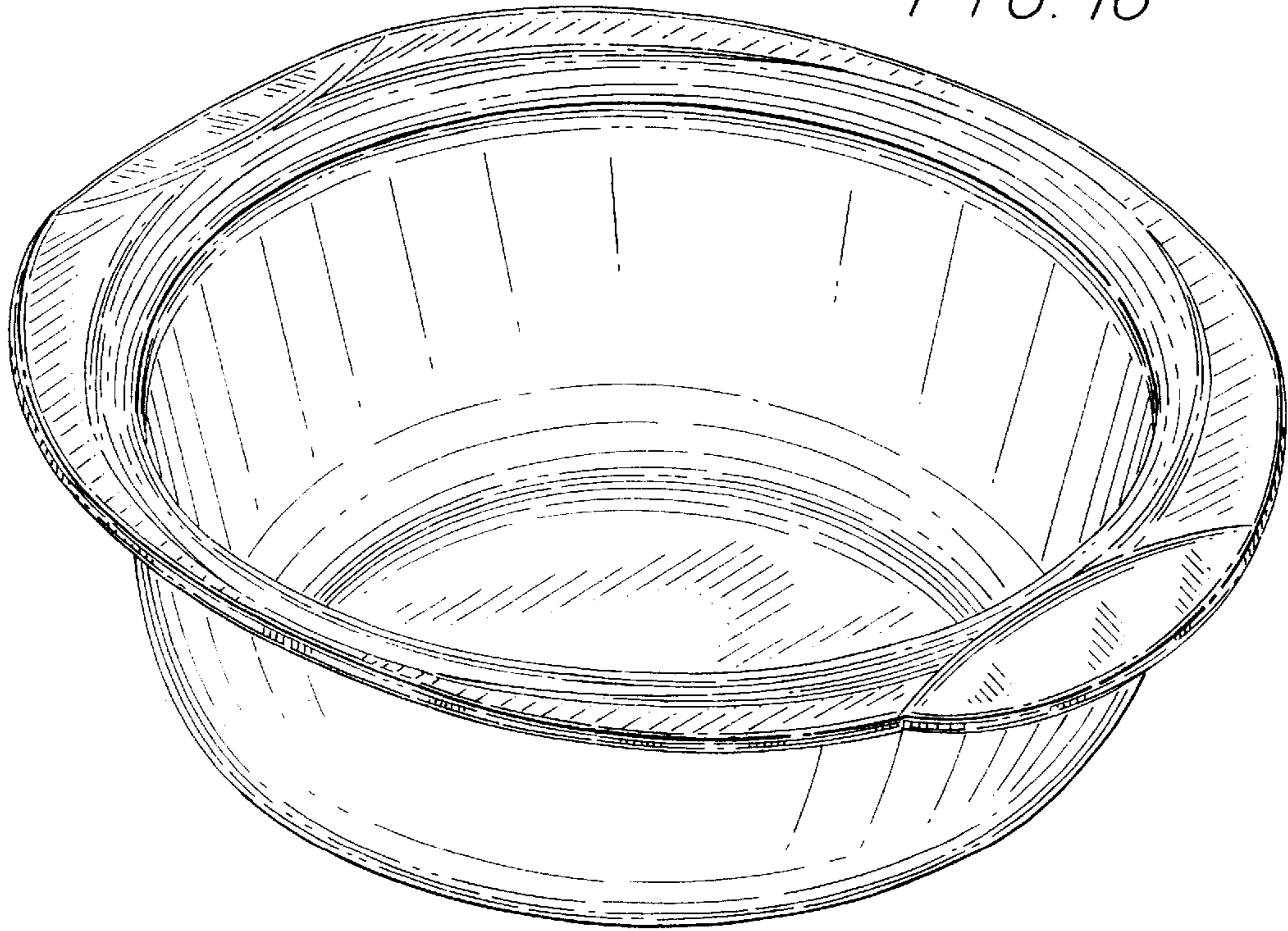

FIG. 17

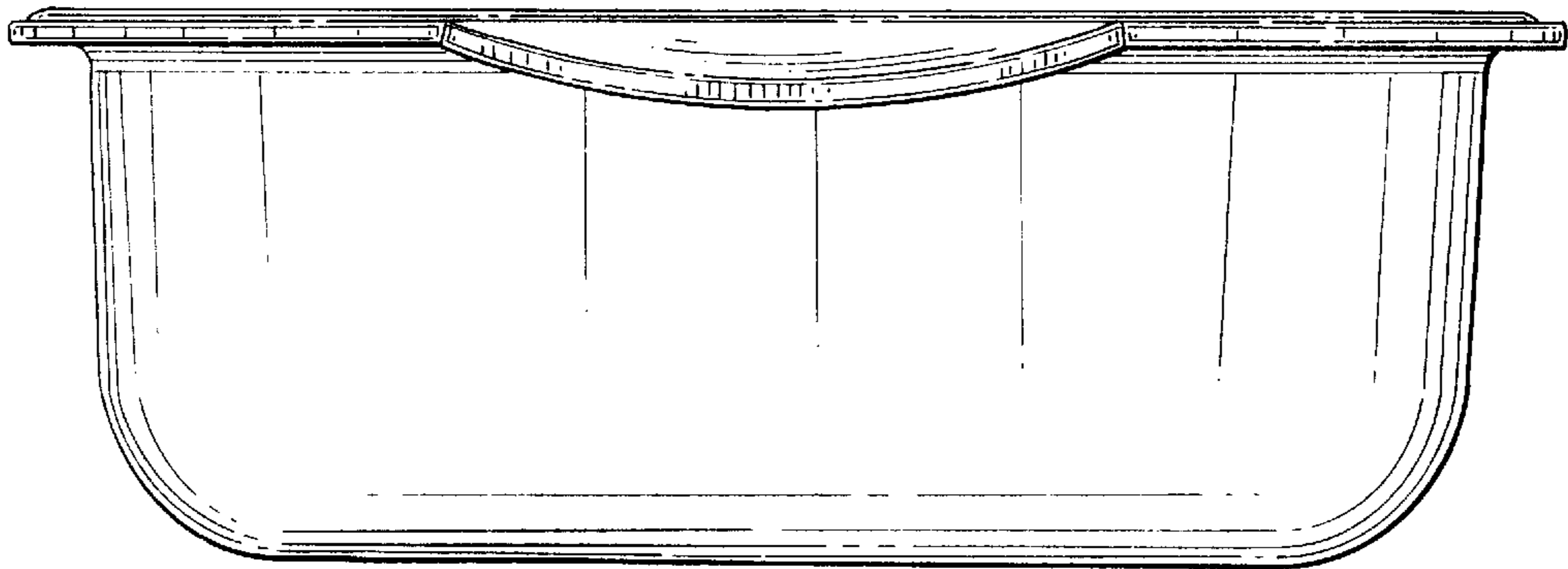

FIG. 18

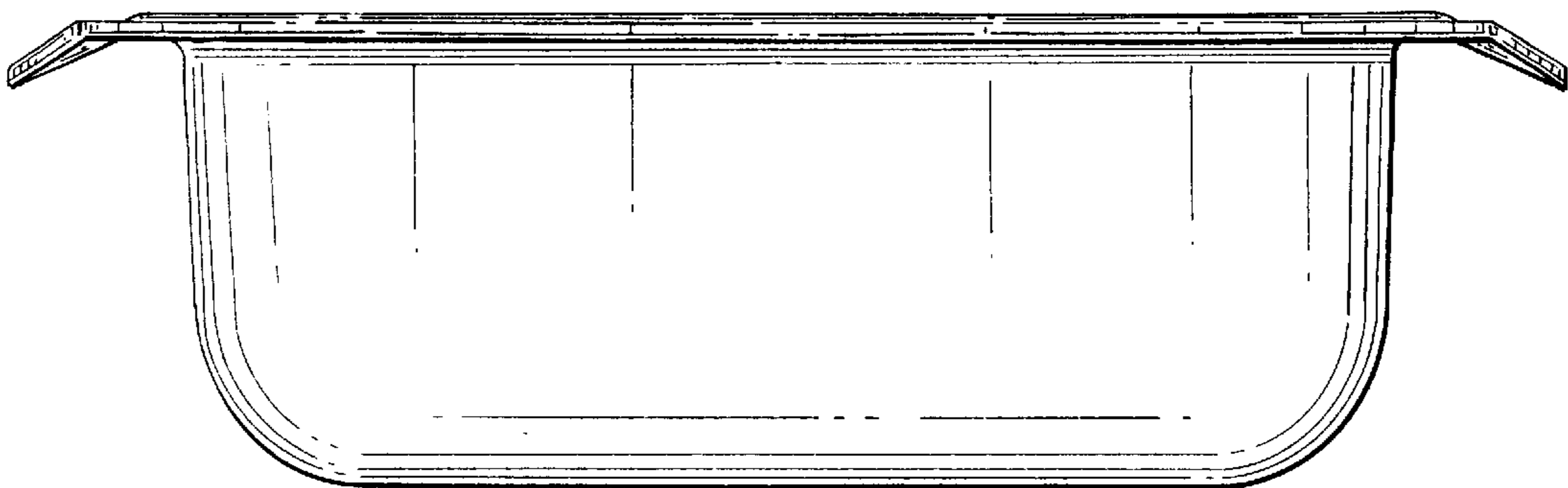

FIG. 19

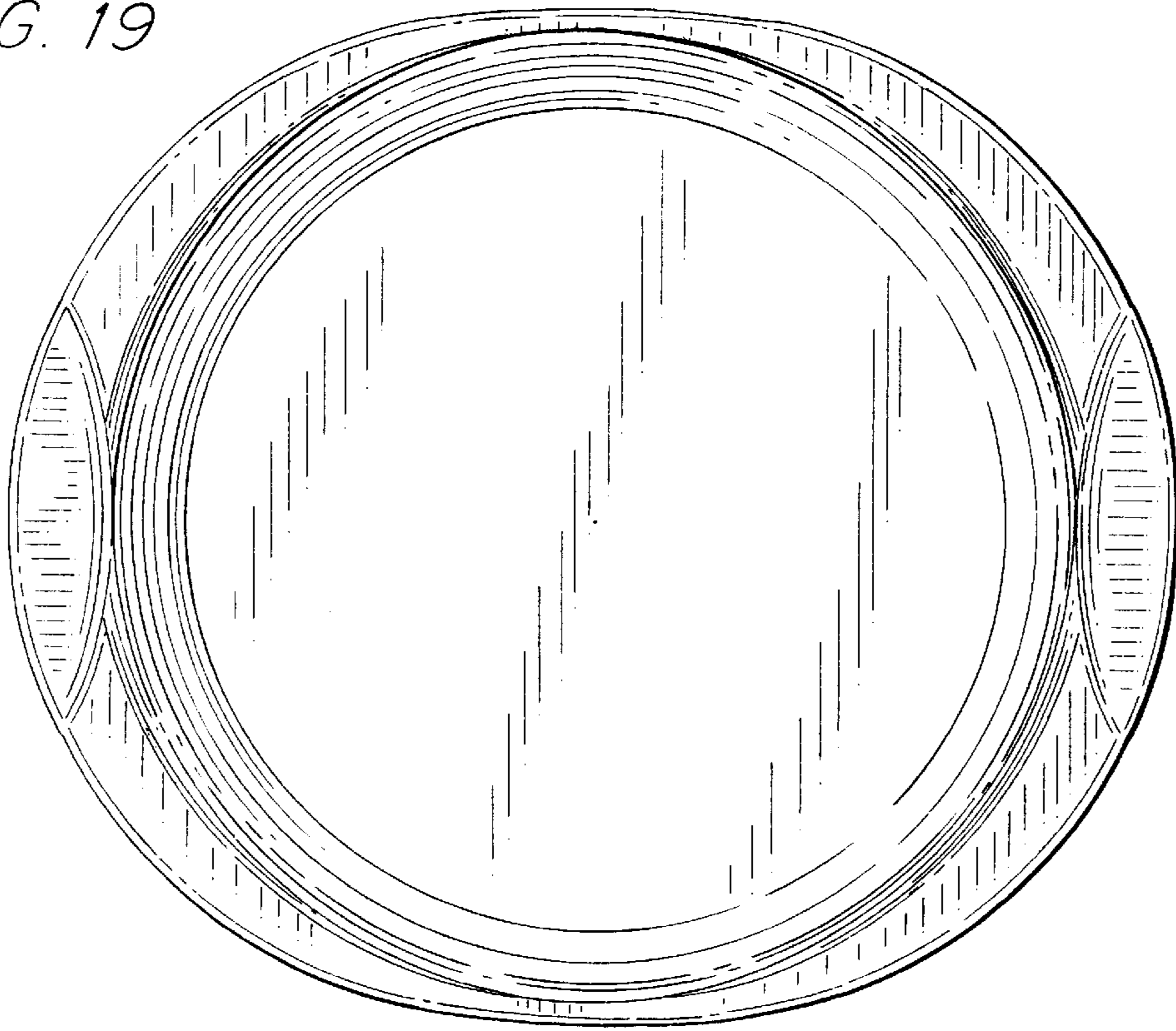

FIG. 20

