



US00D417282S

United States Patent [19]

[11] Patent Number: **Des. 417,282**

Allen

[45] Date of Patent: **** Nov. 30, 1999**

[54] **CLOTHING ITEM WITH POCKETS FOR RECEIVING THERAPEUTIC PACKS**

3,491,761	1/1970	Baker	607/109
3,858,028	12/1974	Kerr	607/106
4,190,054	2/1980	Brennan	607/109
5,809,573	9/1998	Bary	607/109

[76] Inventor: **Mamie Allen**, 309 E. 42nd St., Paterson, N.J. 07504

[**] Term: **14 Years**

Primary Examiner—Louis S. Zarfes
Assistant Examiner—Gregory Andoll
Attorney, Agent, or Firm—Lawrence G. Fridman

[21] Appl. No.: **29/085,049**

[57] **CLAIM**

[22] Filed: **Mar. 16, 1998**

The ornamental design for clothing item with pockets for receiving therapeutic packs, as shown and described.

[51] **LOC (6) Cl.** **24-04**

[52] **U.S. Cl.** **D24/206; D24/207; D2/880**

DESCRIPTION

[58] **Field of Search** D2/866, 865, 878, D2/880; D24/206, 191, 207; D29/102, 103; 607/108-110

FIG. 1 is a front perspective view of the clothing item with pockets for receiving therapeutic packs, showing my new design;

[56] **References Cited**

U.S. PATENT DOCUMENTS

D. 107,836	1/1938	Merkin	D2/880
D. 124,693	1/1941	Kaplan	D2/880
D. 135,632	5/1943	Renke	D2/878
D. 168,822	2/1953	Bland	D29/103
D. 192,953	5/1962	Zelony	D24/207
D. 225,088	11/1972	East	D24/207
D. 295,446	4/1988	Lundell et al.	D24/189
D. 381,792	8/1997	Haddad	D2/898
683,991	10/1901	Rowe	607/110
2,049,723	8/1936	Pomerantz	607/110
3,134,891	5/1964	Hyer	607/109
3,463,161	8/1969	Andrassy	607/110

FIG. 2 is a front elevational view thereof;

FIG. 3 is a rear elevational view thereof;

FIG. 4 is a side elevational view thereof;

FIG. 5 is a top plan view thereof;

FIG. 6 is a bottom plan view thereof;

FIG. 7 shows the embodiment in a flat condition; and,

FIG. 8 is a side elevational view of FIG. 7.

The broken line showing the packs and head in Figures is for illustrative purposes only and forms no part of the claimed design.

The partial rendering of surfaces in the drawings is for ease of illustration. It is understood that the pattern continues throughout the surfaces on which it is only partially shown.

1 Claim, 3 Drawing Sheets

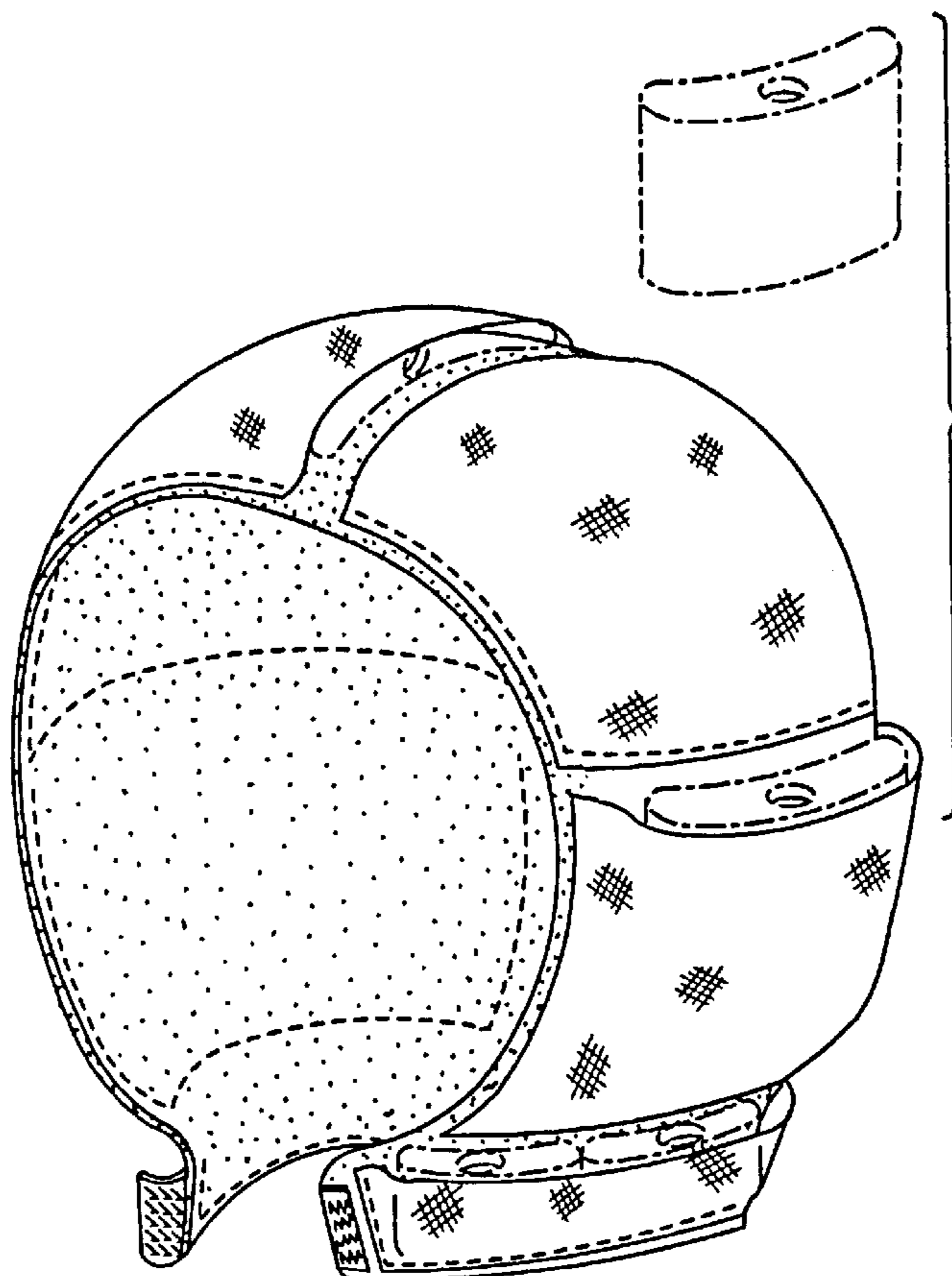

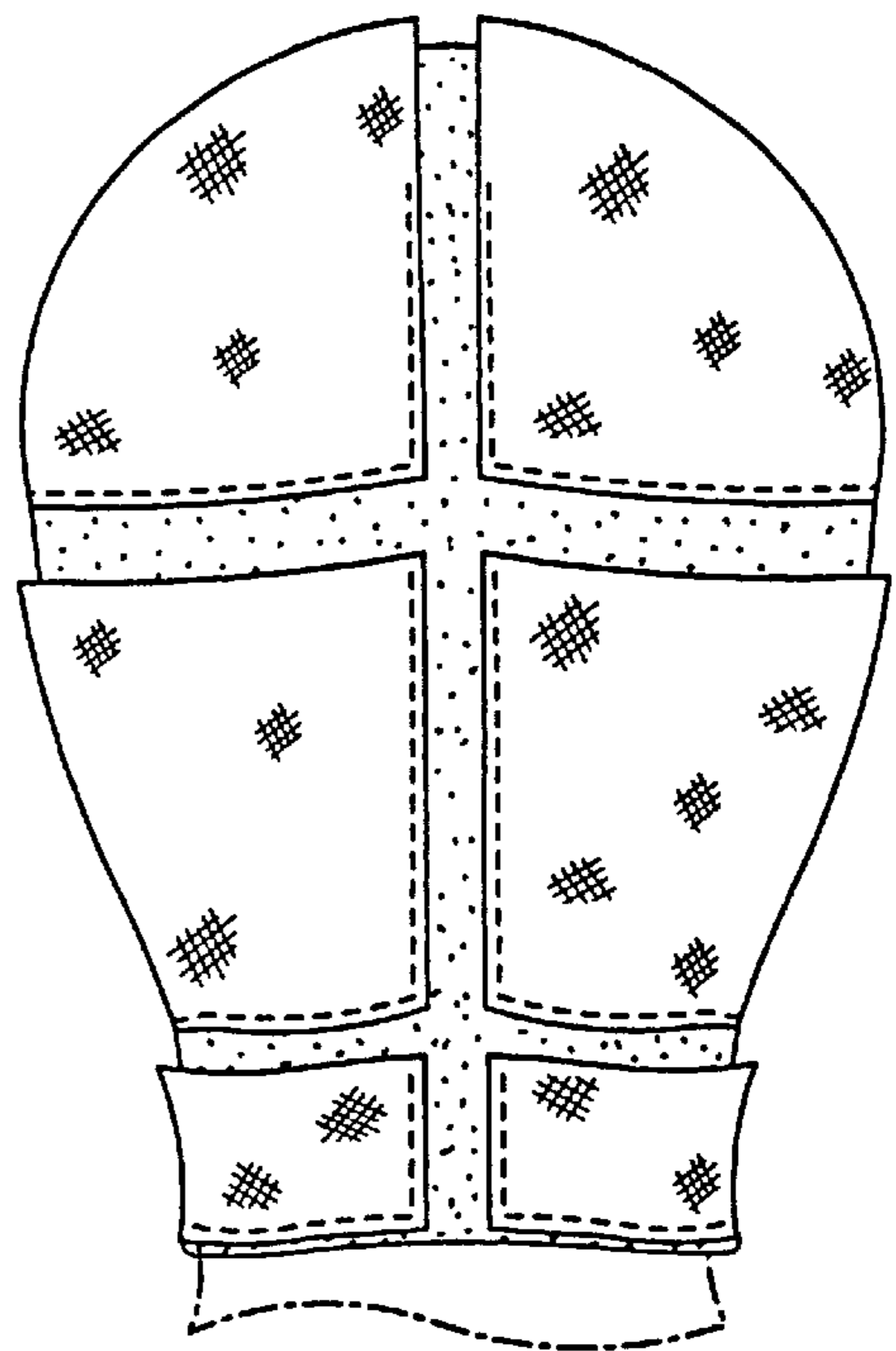
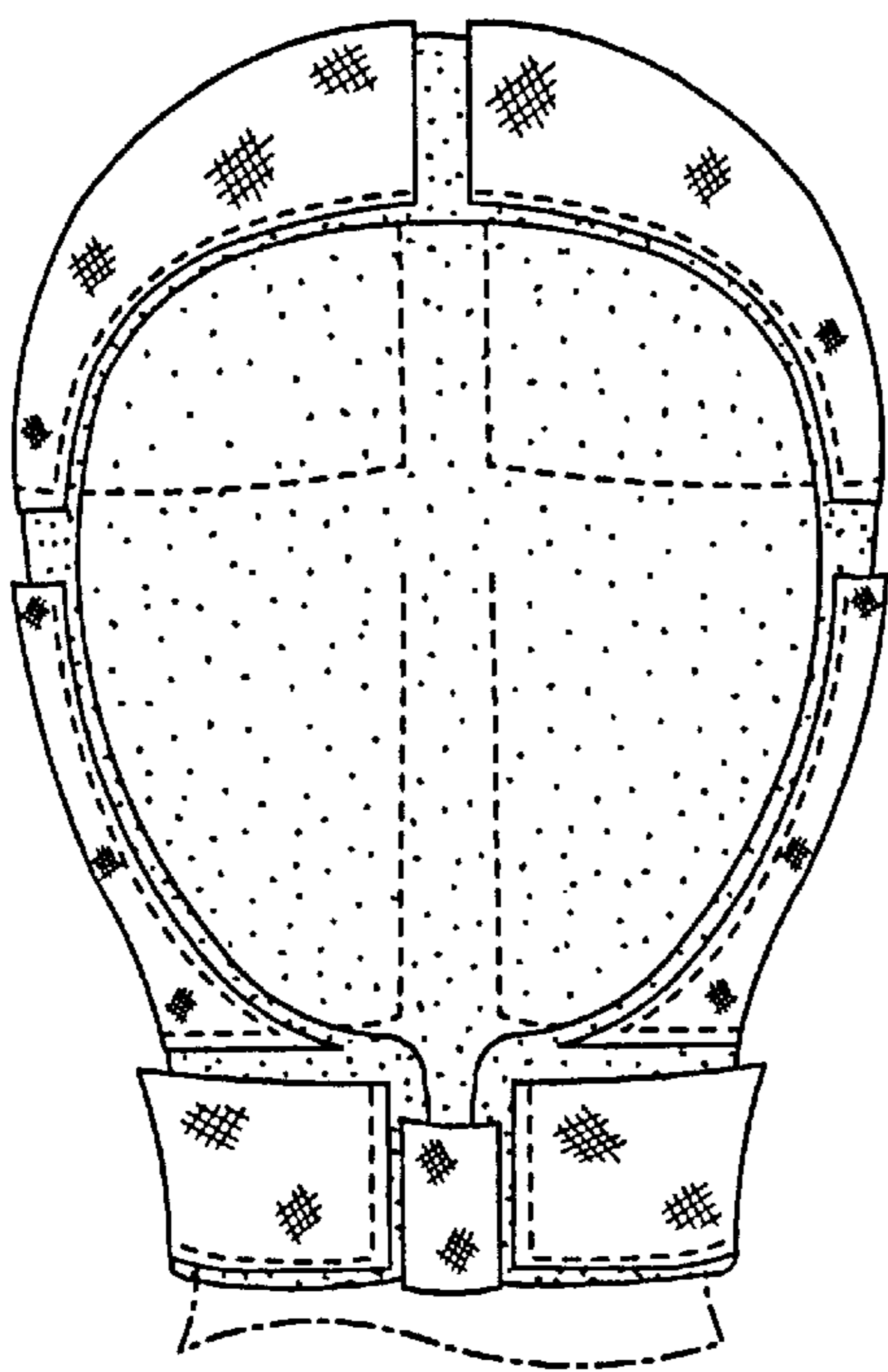
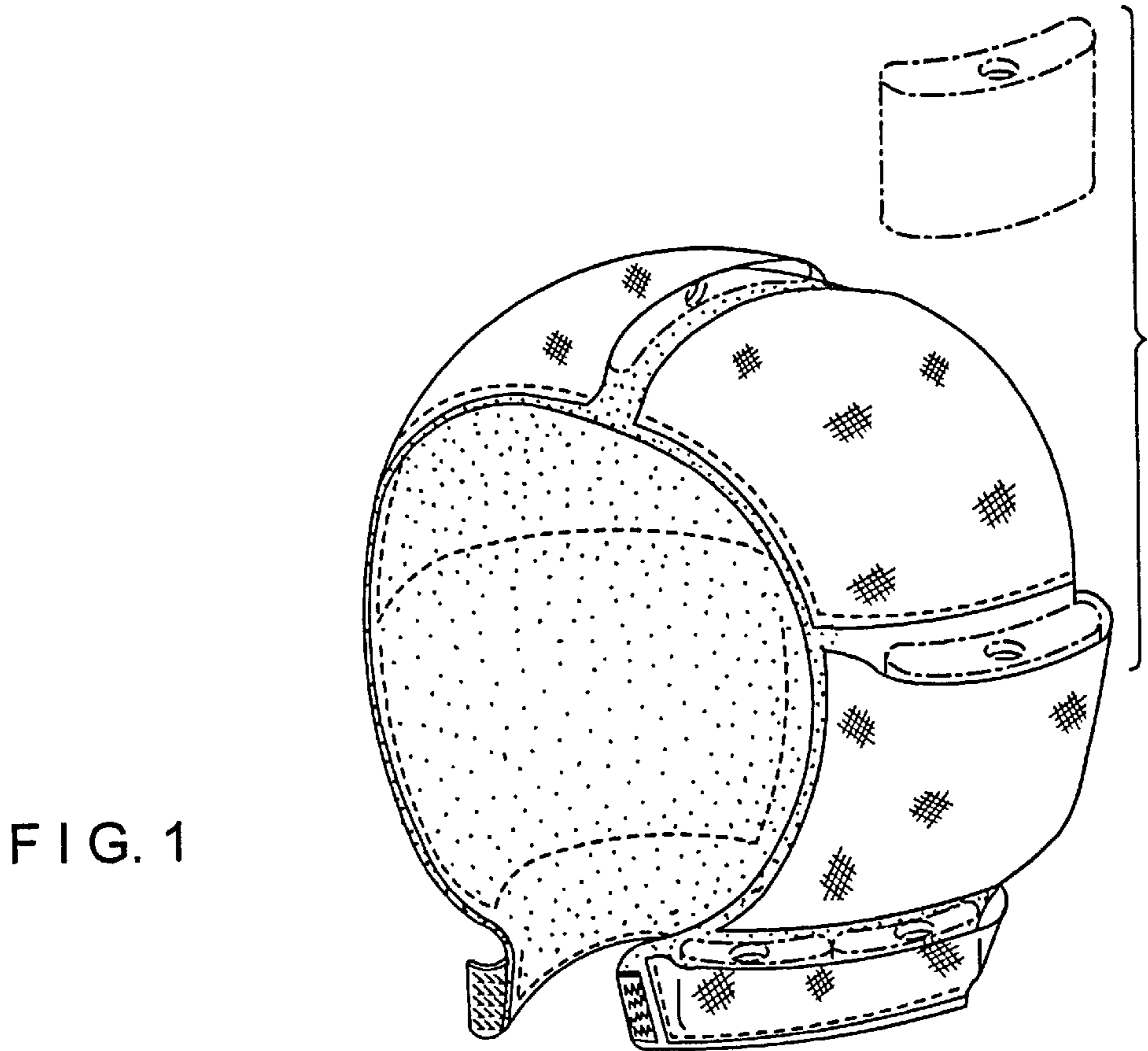

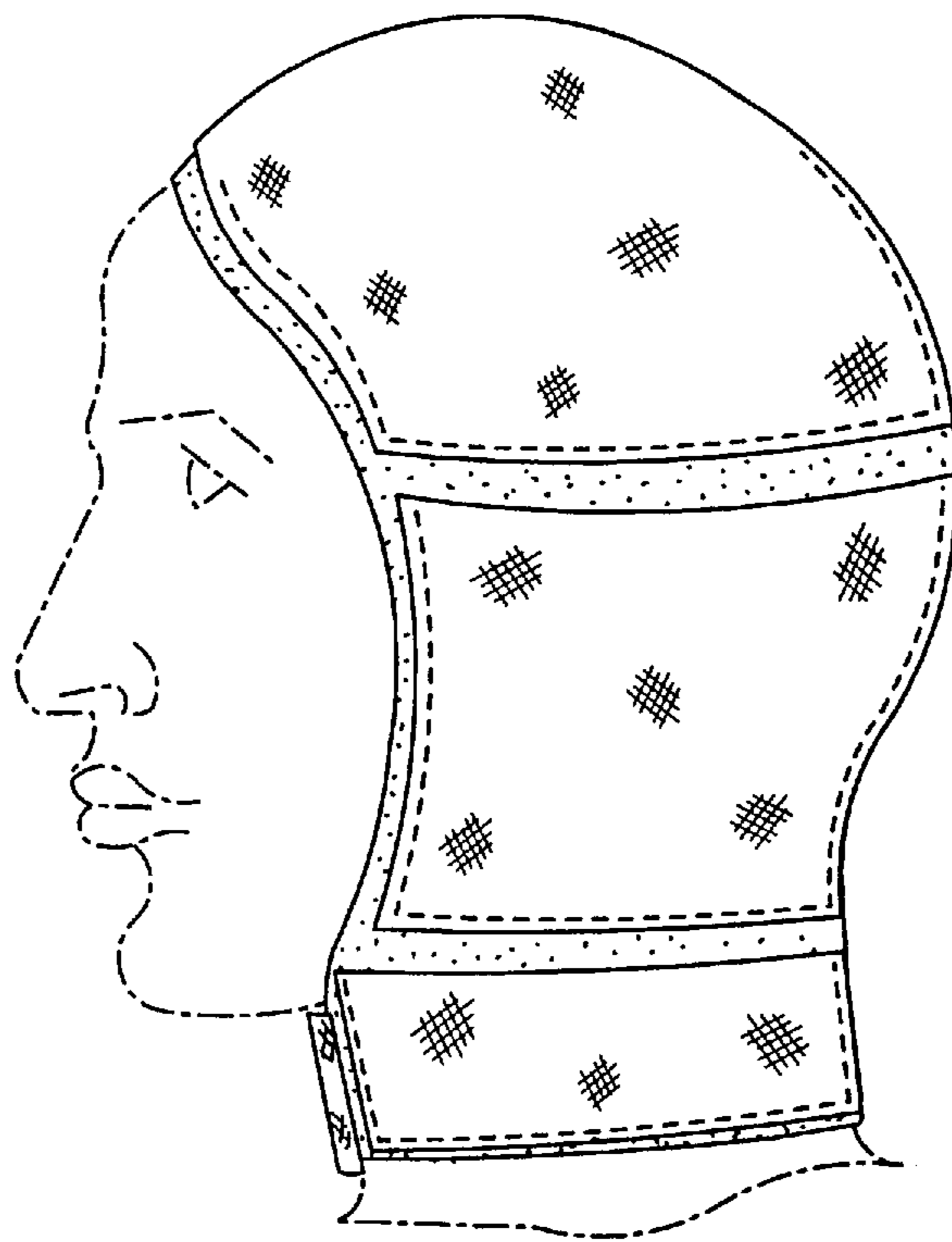

FIG. 4

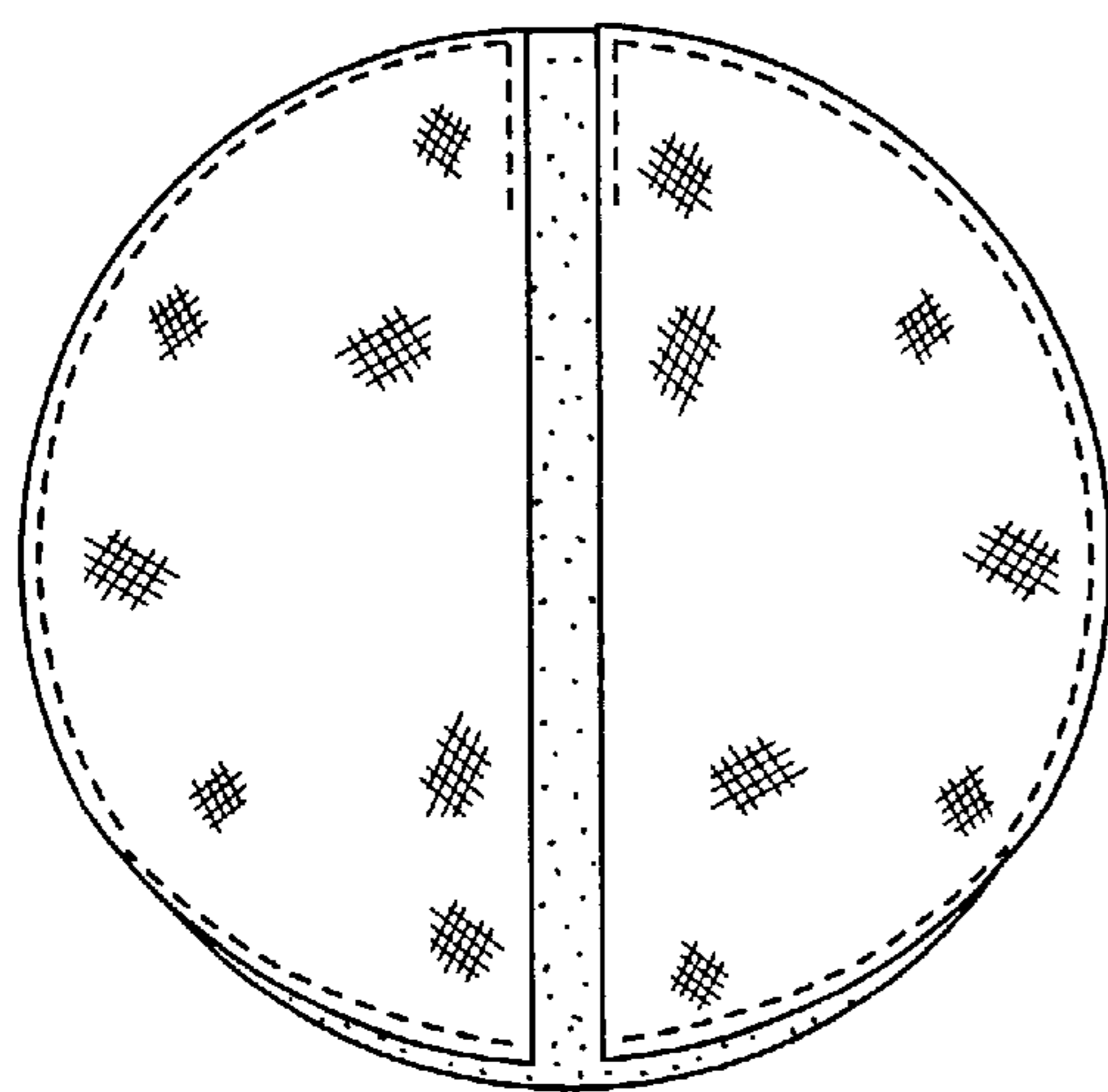

FIG. 5

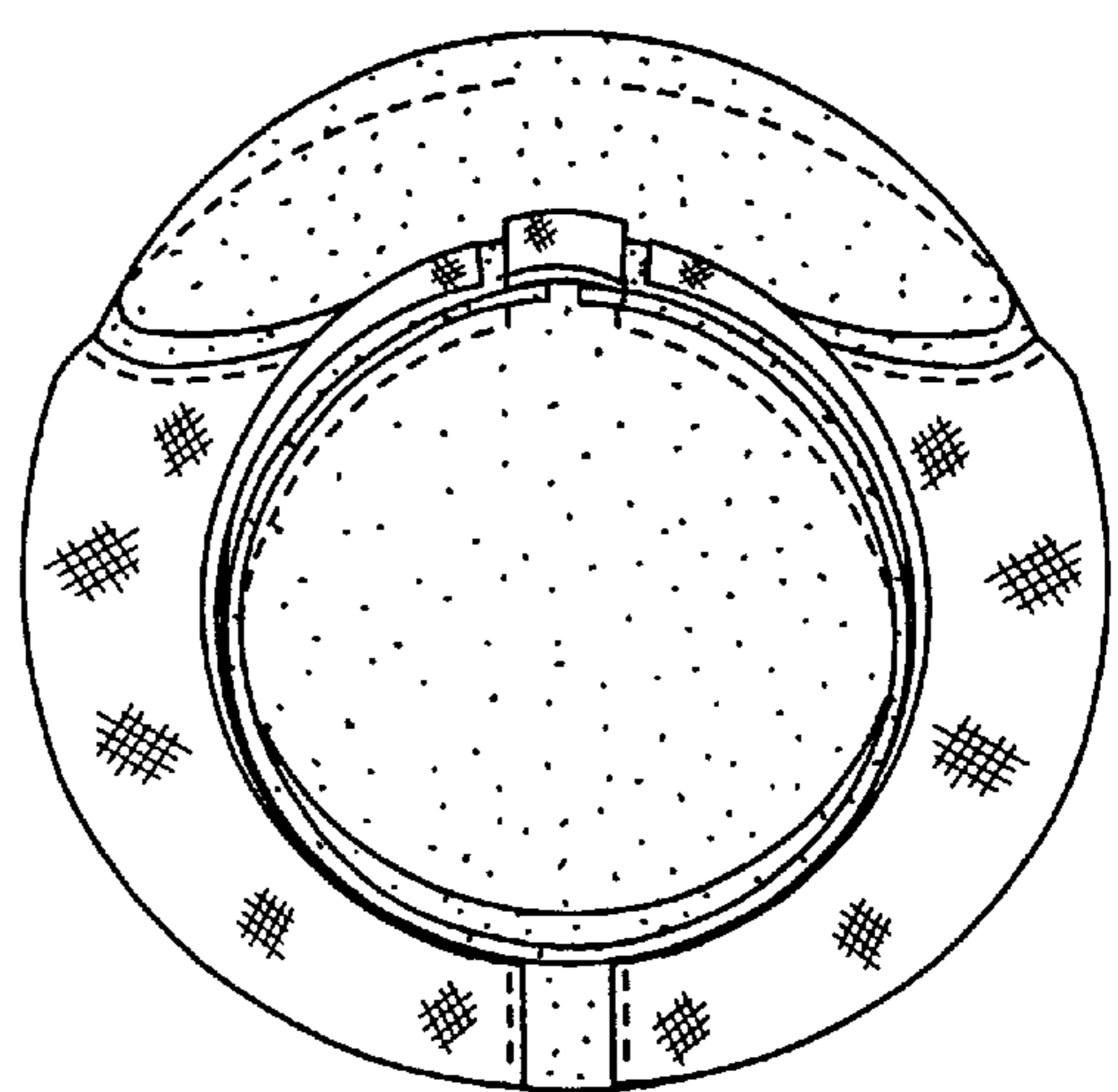

FIG. 6

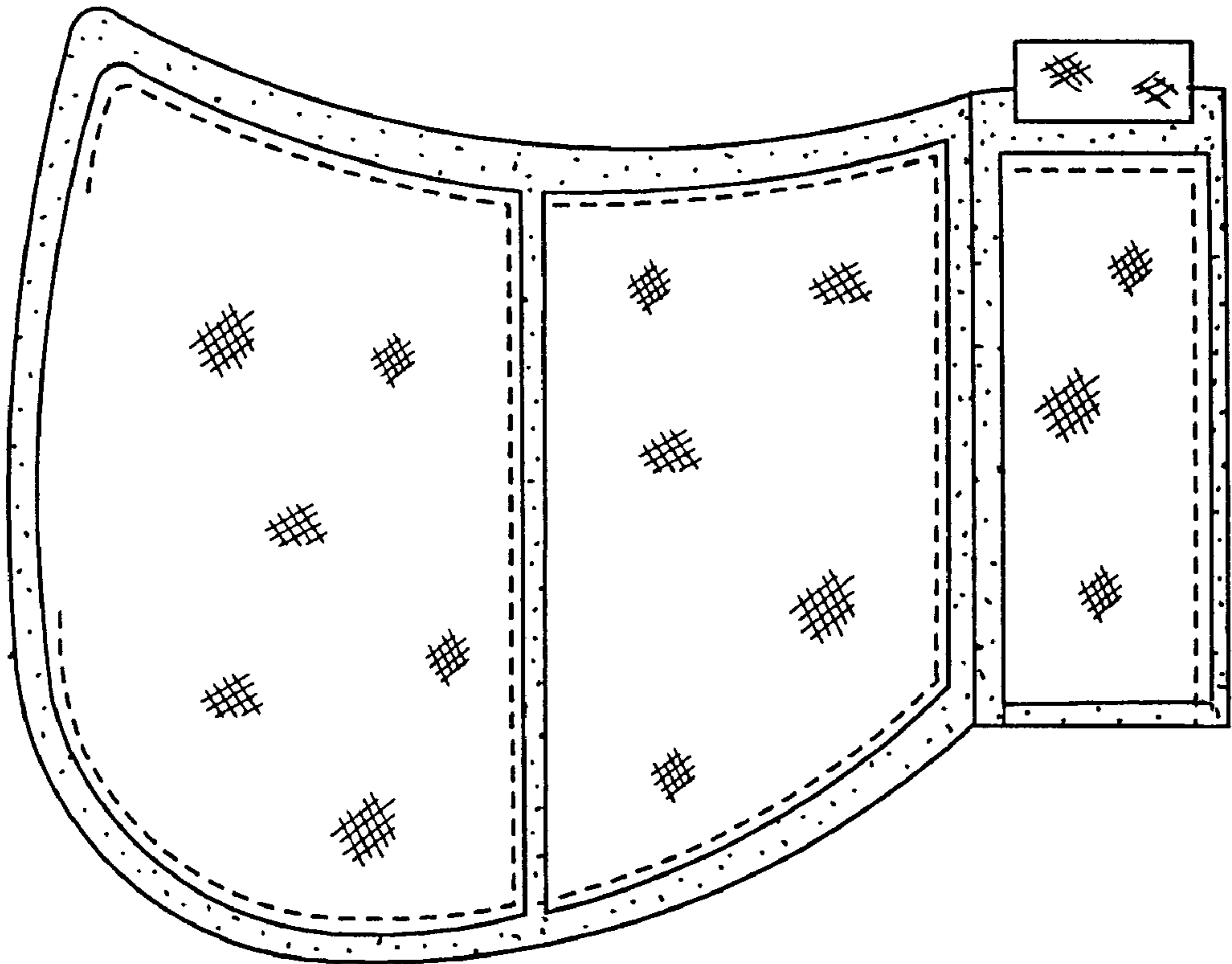

FIG. 7

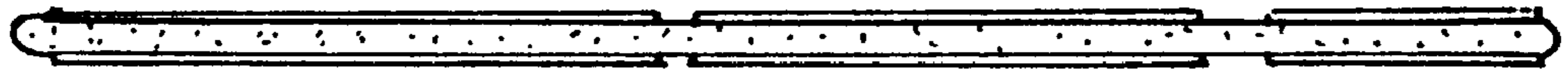

FIG. 8