



US00D417261S

United States Patent [19] Lord

[11] Patent Number: **Des. 417,261**

[45] Date of Patent: **** *Nov. 30, 1999**

[54] **FAUCET WITH PULL-OUT SPOUT**

[75] Inventor: **Judd A. Lord**, Carmel, Ind.

[73] Assignee: **Masco Corporation of Indiana**,
Indianapolis, Ind.

[*] Notice: This patent is subject to a terminal disclaimer.

[**] Term: **14 Years**

[21] Appl. No.: **29/092,673**

[22] Filed: **Aug. 25, 1998**

[51] **LOC (6) Cl.** **23-01**

[52] **U.S. Cl.** **D23/255**

[58] **Field of Search** D23/238-243,
D23/250-257, 213; 4/675-678; 137/801

[56] **References Cited**

U.S. PATENT DOCUMENTS

- D. 213,874 4/1969 Landell .
- D. 219,779 1/1971 Tiller .
- D. 290,492 6/1987 Hill et al. .
- D. 290,992 7/1987 Hill et al. .
- D. 291,117 7/1987 Ryan .
- D. 293,601 1/1988 Hill et al. .
- D. 323,877 2/1992 Haug et al. .
- D. 331,796 12/1992 Spangler .
- D. 352,766 11/1994 Hill et al. .
- D. 360,931 8/1995 Mark et al. .
- D. 363,536 10/1995 Hill et al. .
- D. 364,211 11/1995 Hill et al. .
- D. 364,218 11/1995 Hill et al. .

- D. 364,219 11/1995 Hill et al. .
- D. 364,220 11/1995 Hill et al. .
- D. 366,099 1/1996 Hill et al. .
- D. 367,697 3/1996 Haug et al. .
- D. 367,699 3/1996 Hill et al. .
- D. 367,701 3/1996 Hill et al. .
- D. 367,920 3/1996 Hill et al. .
- D. 368,764 4/1996 Hill et al. .
- D. 368,958 4/1996 Hill et al. .
- D. 388,156 12/1997 Hill et al. .

OTHER PUBLICATIONS

Delta Full Line Catalog, pp. 4, 5, 1994.
Delta Catalog, "The Way Water is Brought to Life", 2 pages, 1991.

Primary Examiner—Eric Watterson
Attorney, Agent, or Firm—Myron B. Kapustij; Lloyd D. Doigan

[57] **CLAIM**

The ornamental design for a faucet with pull-out spout, as shown and described.

DESCRIPTION

FIG. 1 is a top, rear perspective view of the faucet with pull-out spout showing my new design;
FIG. 2 is a front perspective view thereof;
FIG. 3 is a right side elevational view thereof, the left side being a mirror image;
FIG. 4 is a front elevational view thereof;
FIG. 5 is a top plan view thereof;
FIG. 6 is a rear elevational view thereof; and,
FIG. 7 is a bottom plan view thereof.

1 Claim, 3 Drawing Sheets

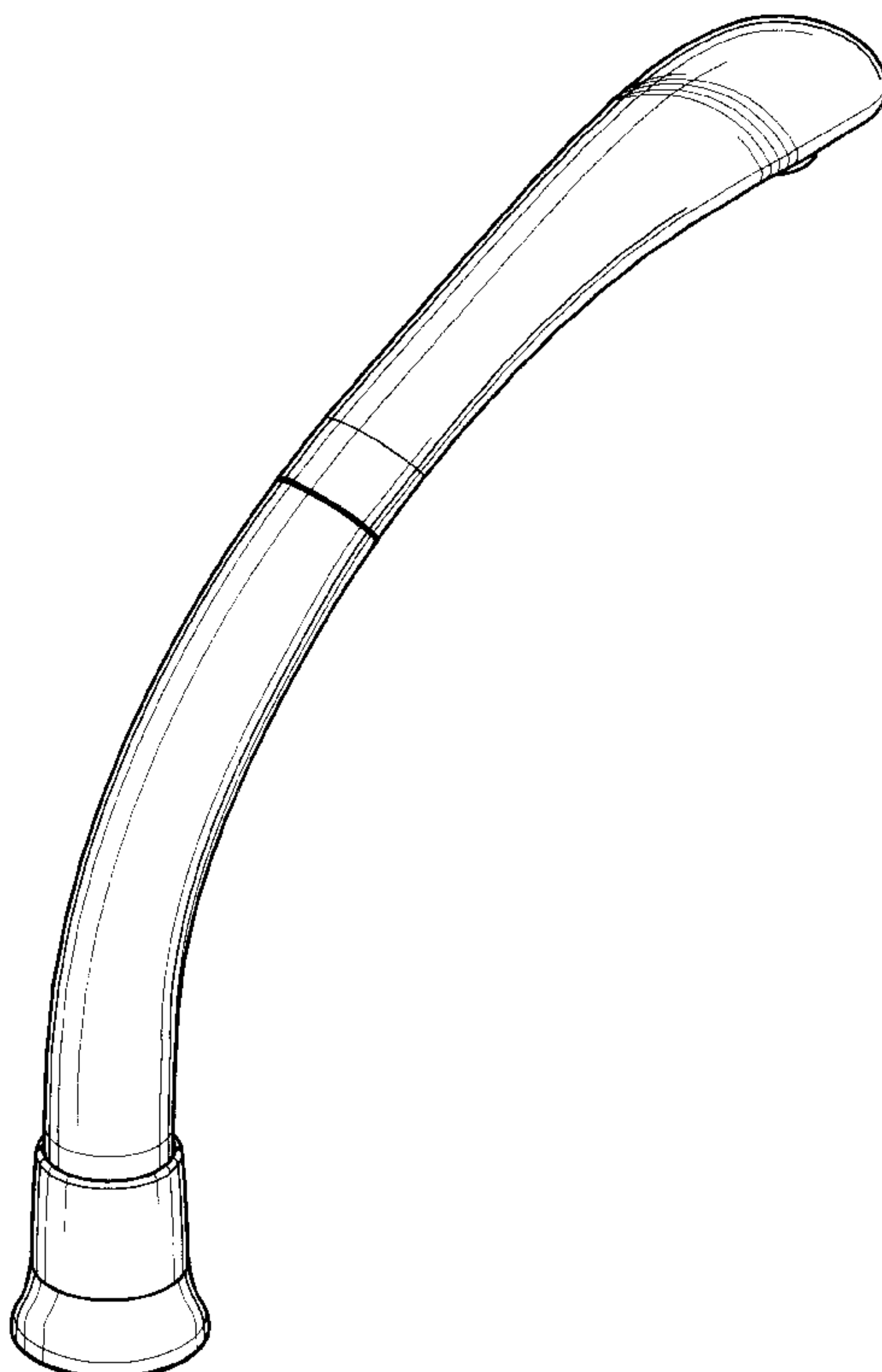

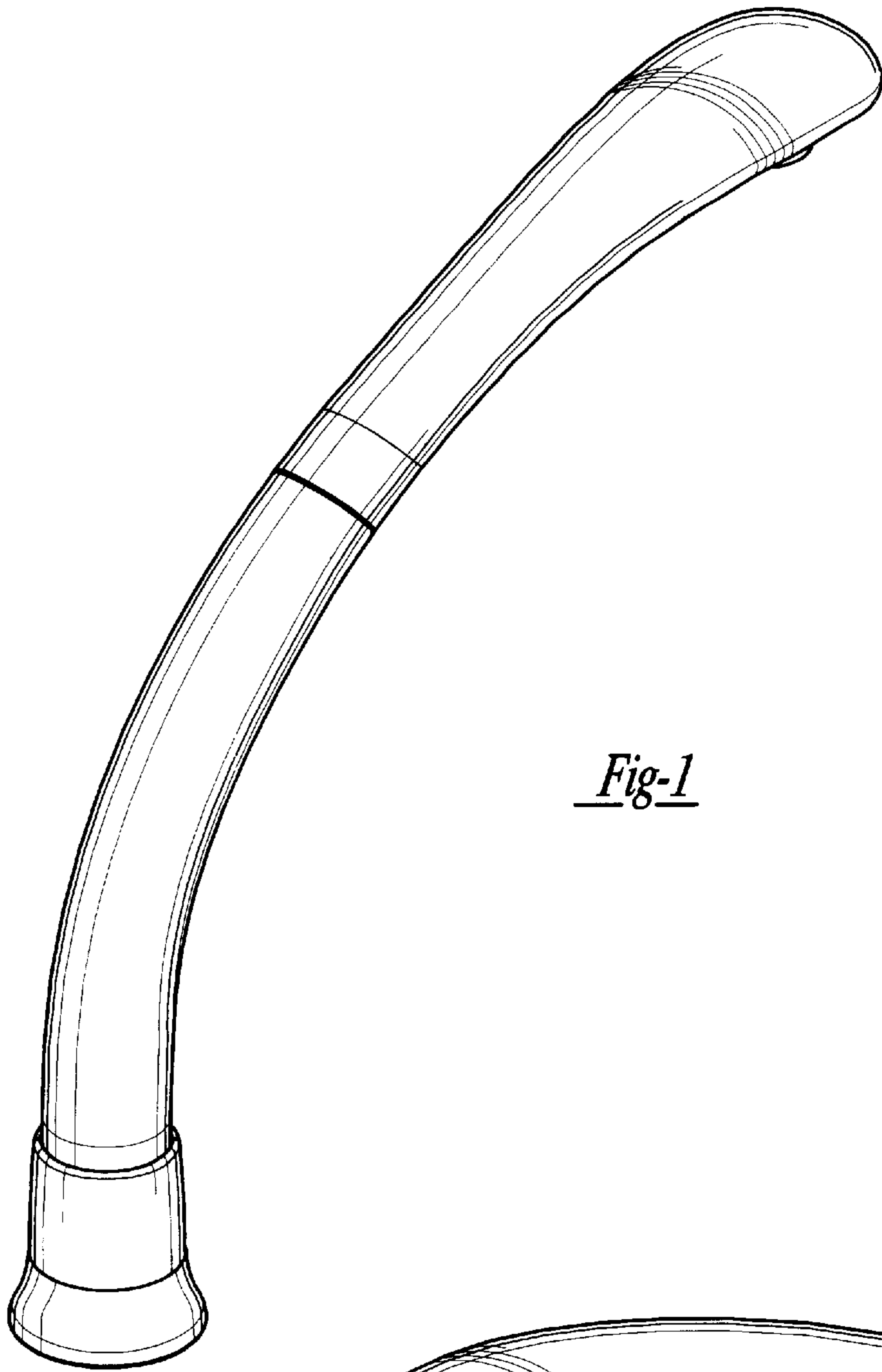

Fig-1

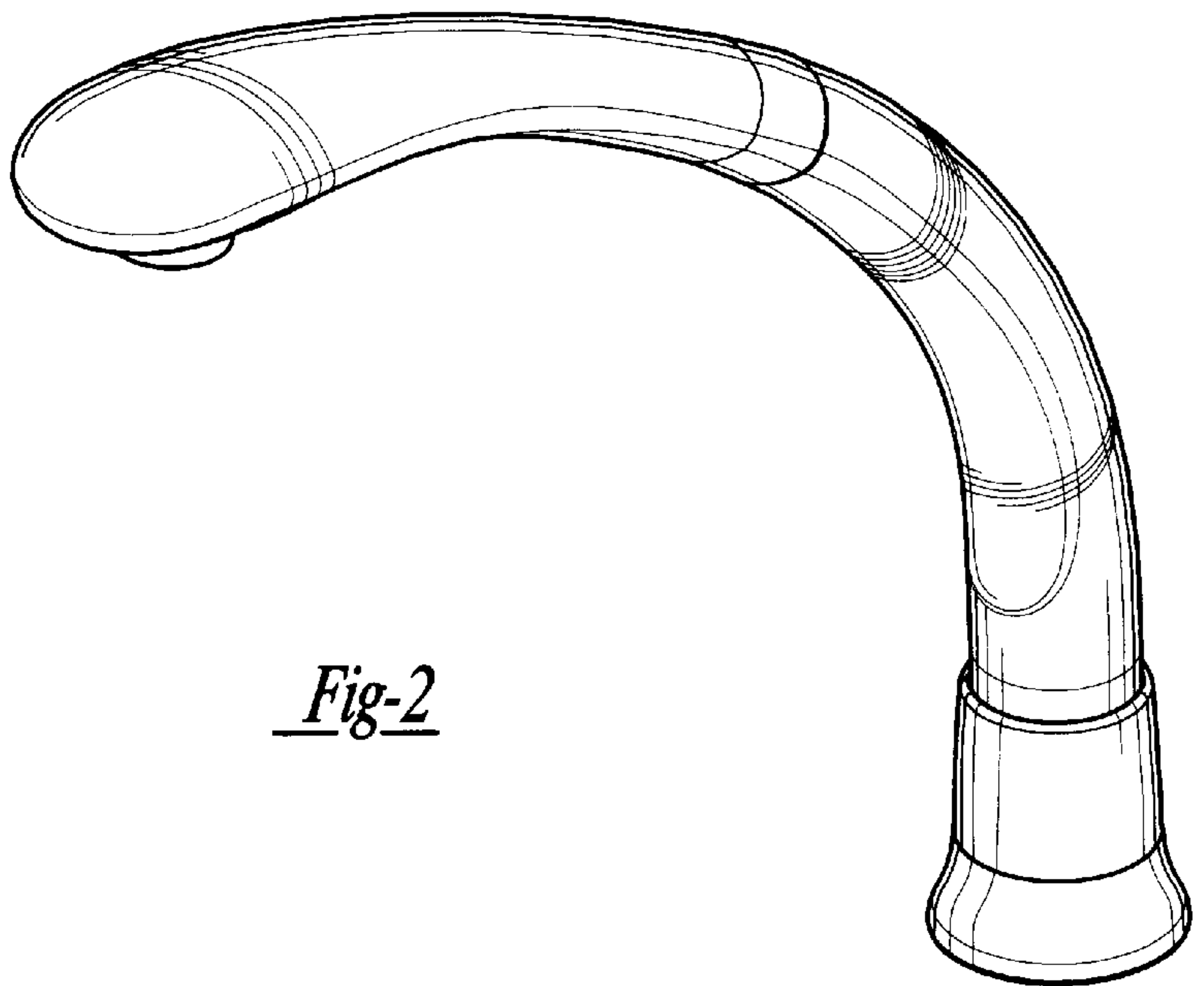

Fig-2

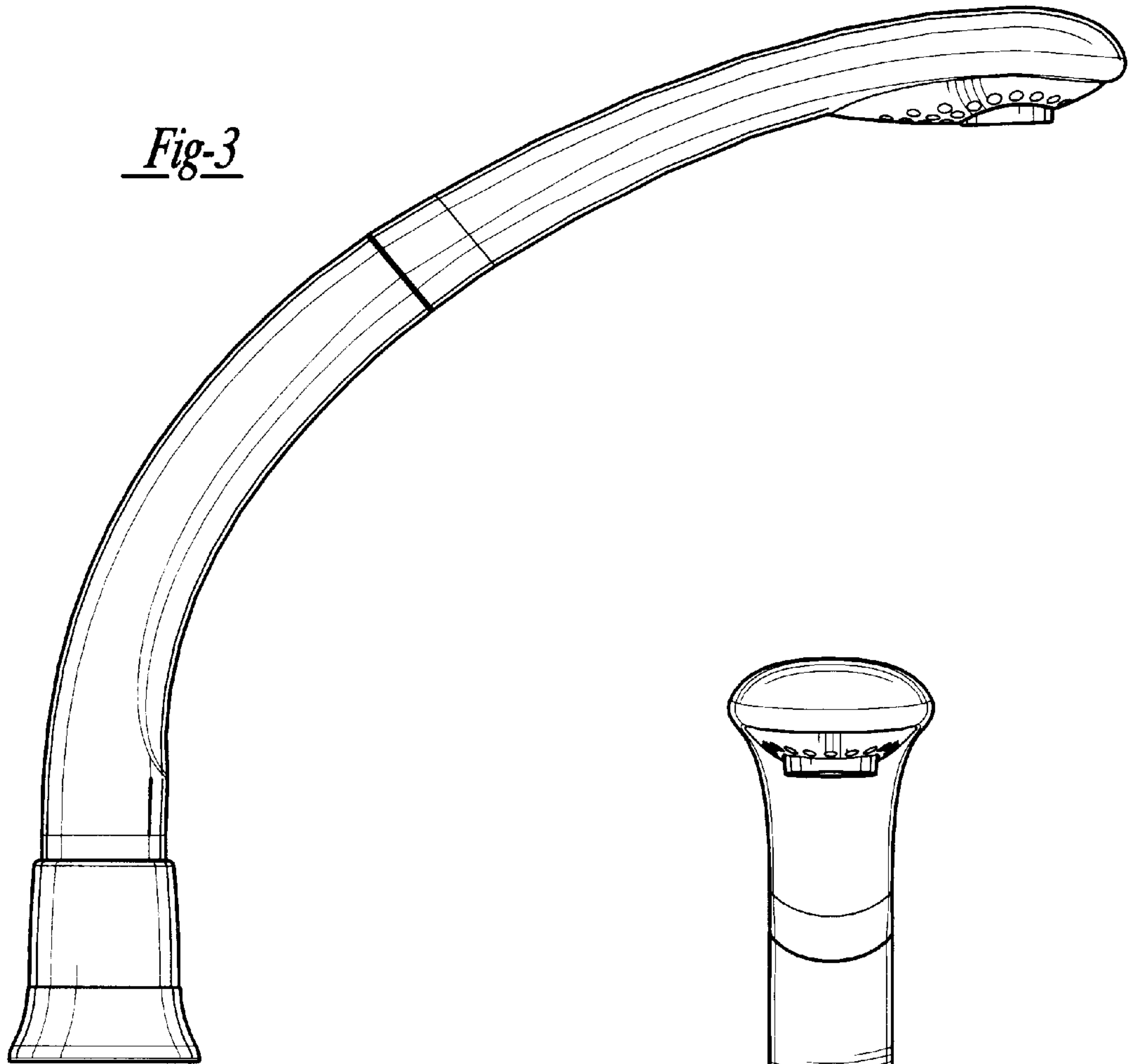
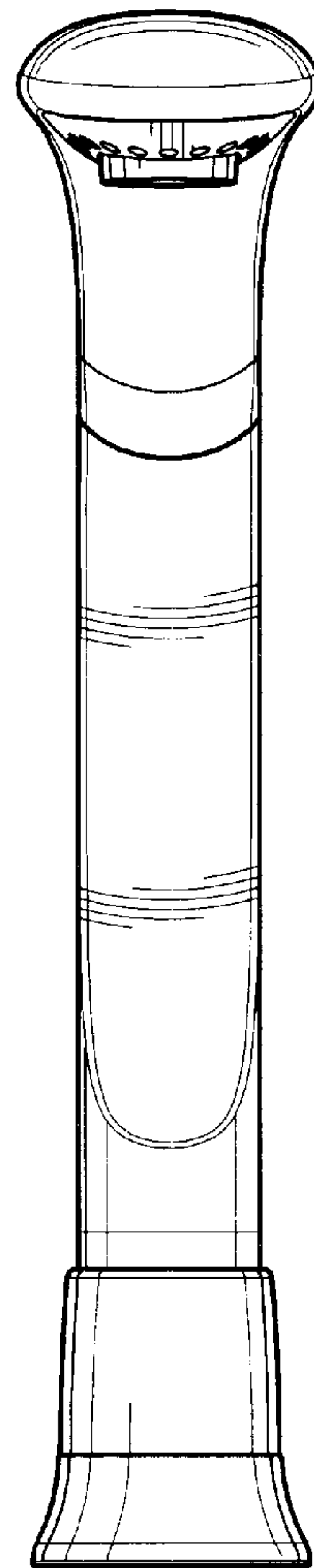

Fig-4



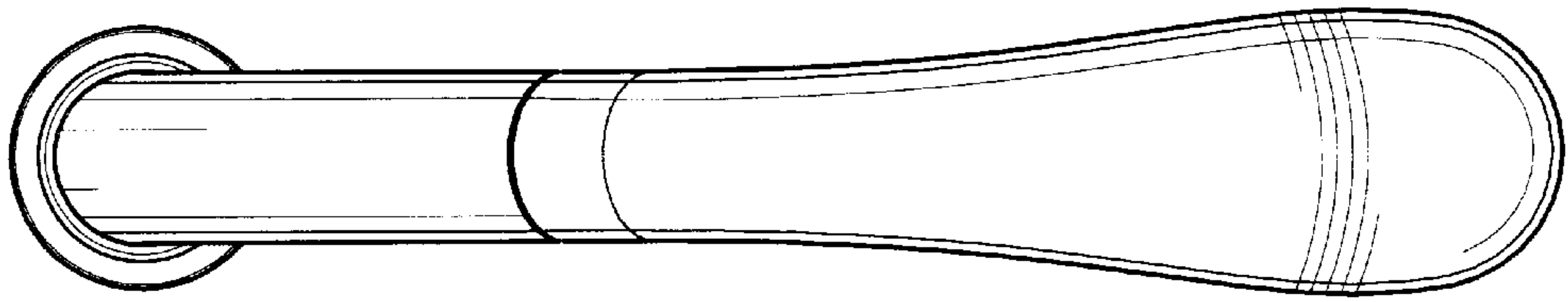

Fig-5

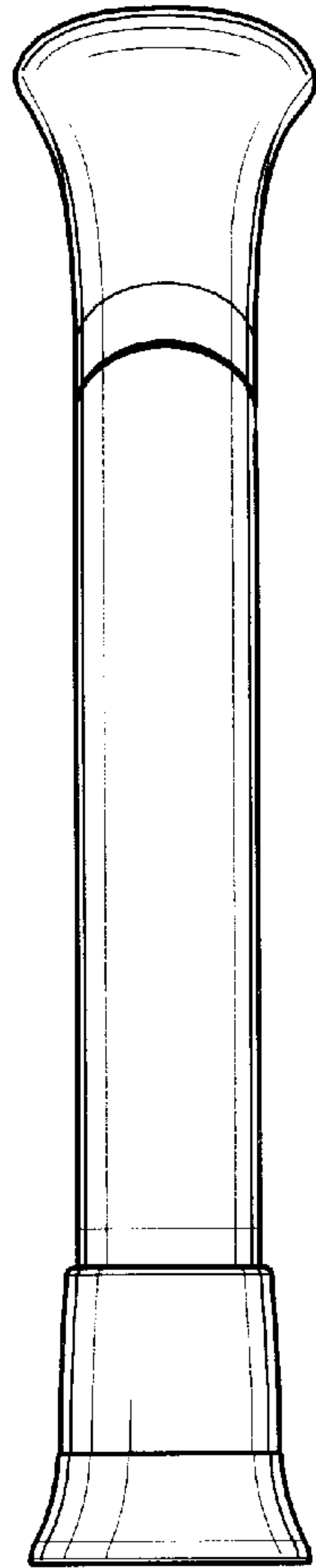

Fig-6

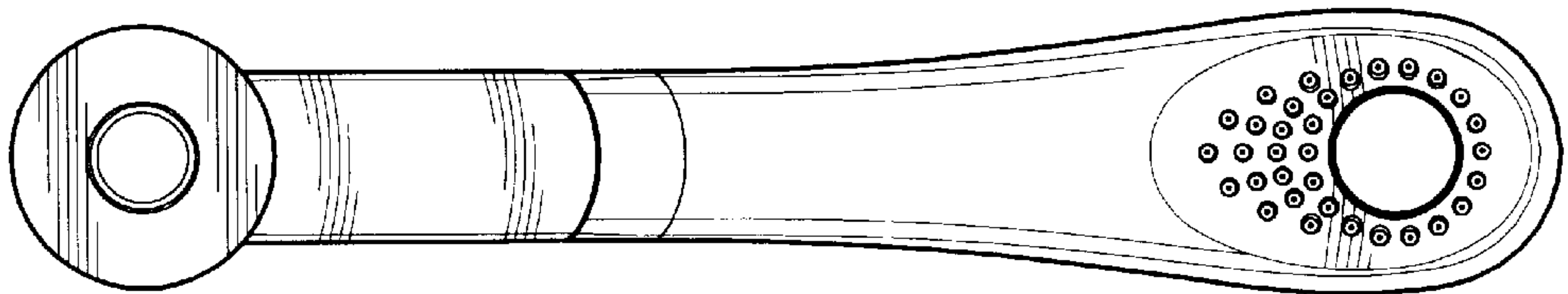

Fig-7