



US00D417220S

# United States Patent [19]

Godette et al.

[11] **Patent Number: Des. 417,220**

[45] **Date of Patent: \*\* Nov. 30, 1999**

[54] **REMOTE CONTROLLER**

[75] Inventors: **Robert G. Godette**, Downey; **Michael Nermon**, Tustin, both of Calif.

[73] Assignee: **L&P Property Management Company**, South Gate, Calif.

[\*\*] Term: **14 Years**

[21] Appl. No.: **29/091,314**

[22] Filed: **Jul. 27, 1998**

[51] **LOC (6) Cl.** ..... **14-03**

[52] **U.S. Cl.** ..... **D14/218**

[58] **Field of Search** ..... D14/124, 217, D14/218, 299; D10/104, 106; D13/168; 348/734; 455/151.1-151.4, 152.1, 352-355; 200/331

[56] **References Cited**

**U.S. PATENT DOCUMENTS**

- D. 339,137 9/1993 Takeda ..... D14/218
- D. 346,152 4/1994 Zaugg ..... D13/168
- D. 355,895 2/1995 Soren et al. .... D14/218

- D. 361,058 8/1995 Domel et al. .... D13/168
- D. 375,057 10/1996 Heun ..... D10/104
- D. 375,696 11/1996 Seki et al. .... D10/104
- D. 385,207 10/1997 Urovy ..... D10/104
- 5,481,251 1/1996 Buys et al. .... 455/151.2

*Primary Examiner*—Louis S. Zarfaz  
*Assistant Examiner*—G. Andoll  
*Attorney, Agent, or Firm*—Blakely, Sokoloff, Taylor & Zafman LLP

[57] **CLAIM**

The ornamental design for a remote controller, as shown and described.

**DESCRIPTION**

FIG. 1 is a perspective view of a remote controller showing the rear, top and right side of our design; FIG. 2 is a top plan view thereof; FIG. 3 is a front elevation view thereof; FIG. 4 is a rear elevation view thereof; FIG. 5 is a bottom plan view thereof; and, FIG. 6 is a left side elevation view thereof, the right side being a mirror image.

**1 Claim, 2 Drawing Sheets**

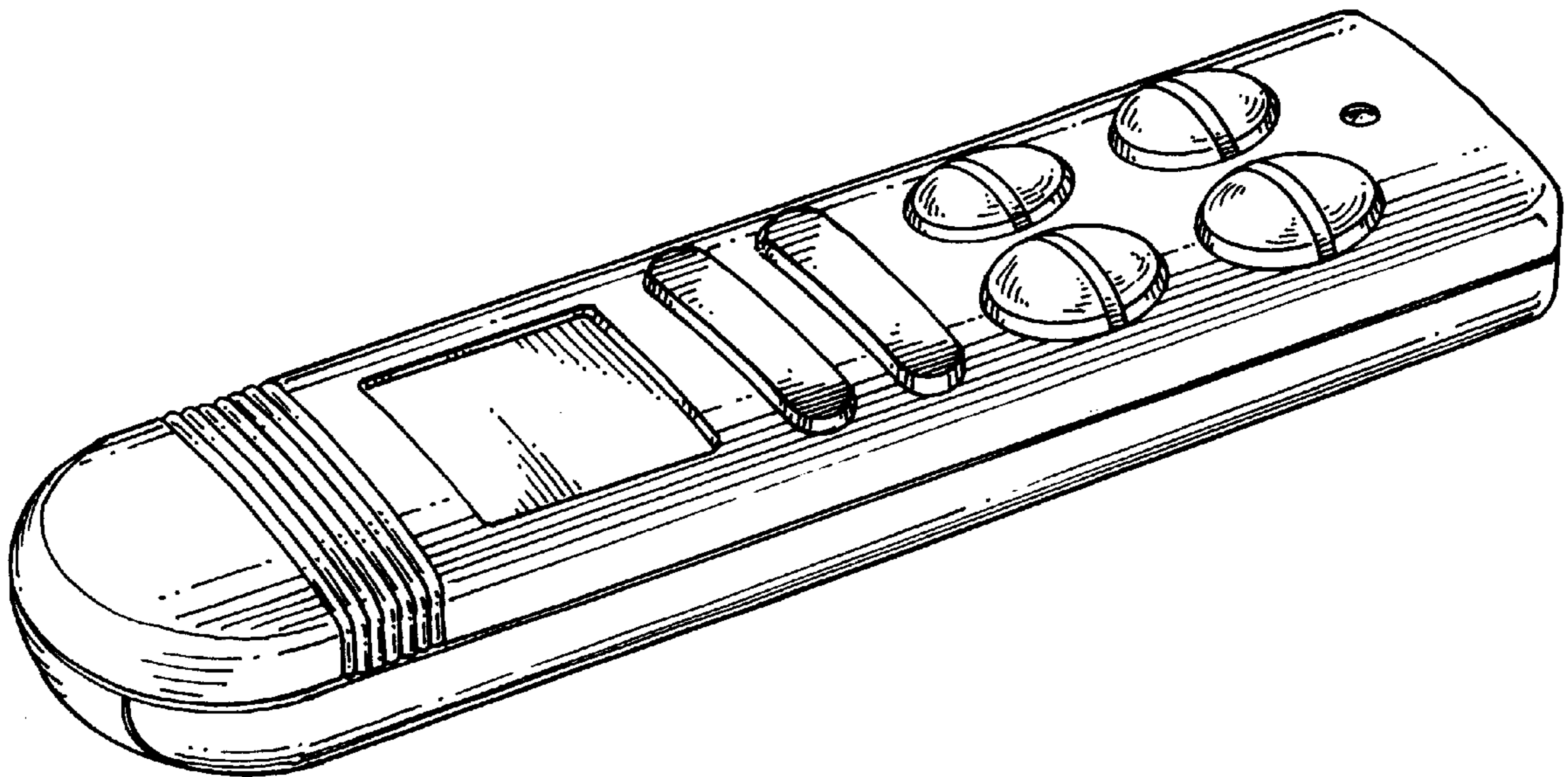

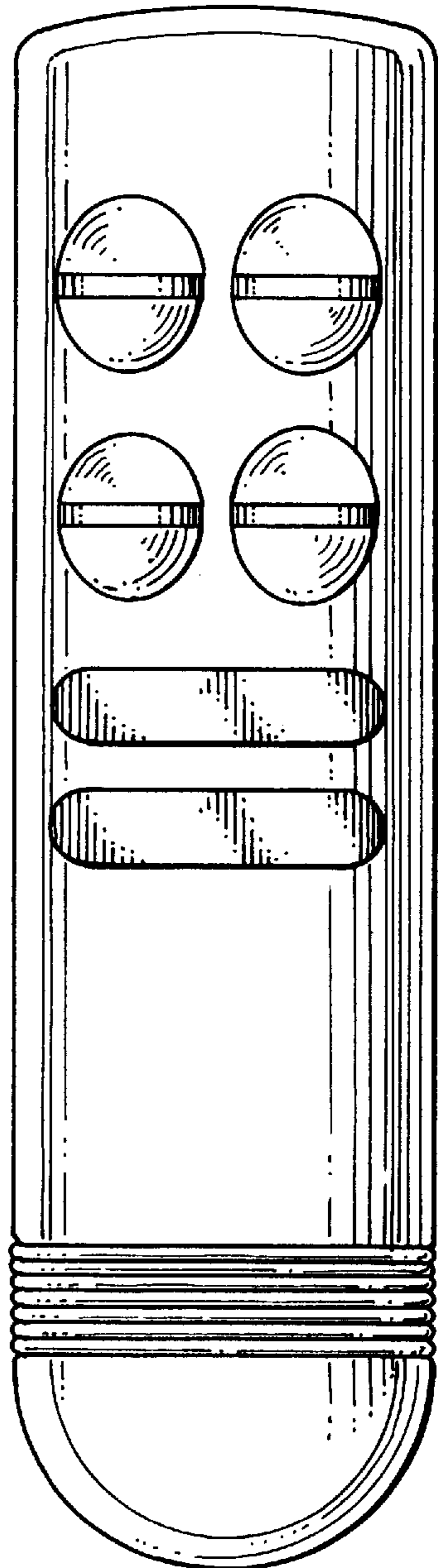
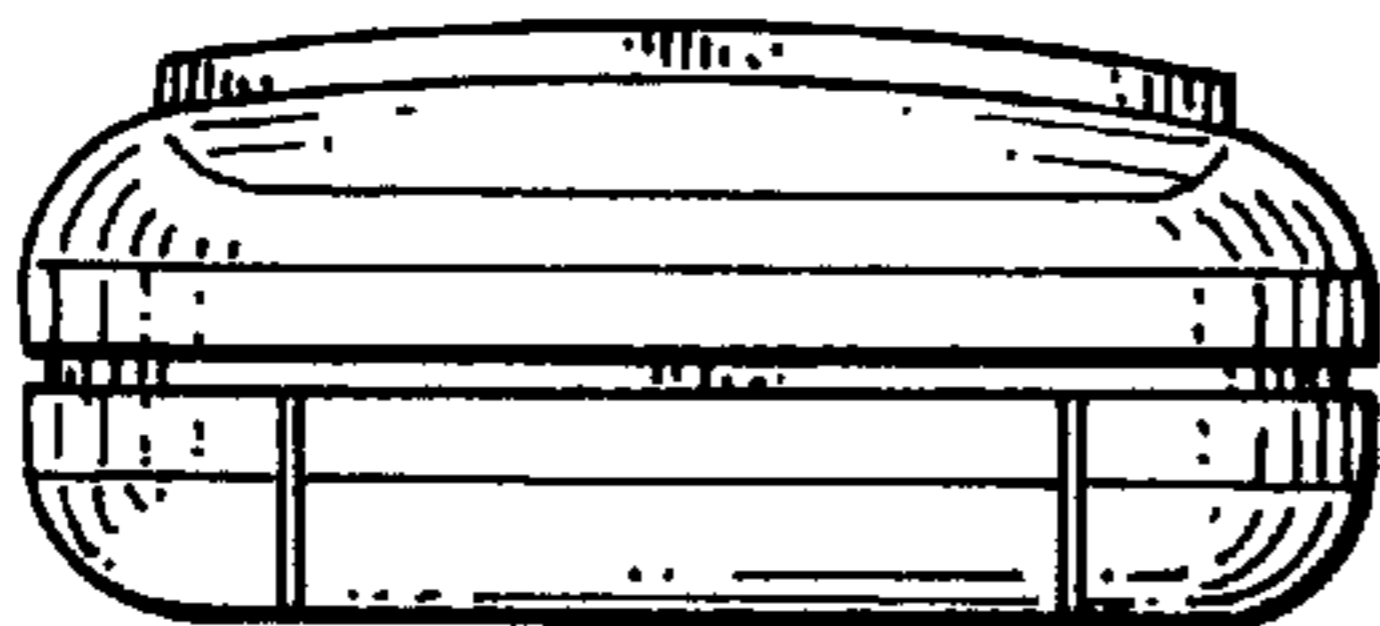
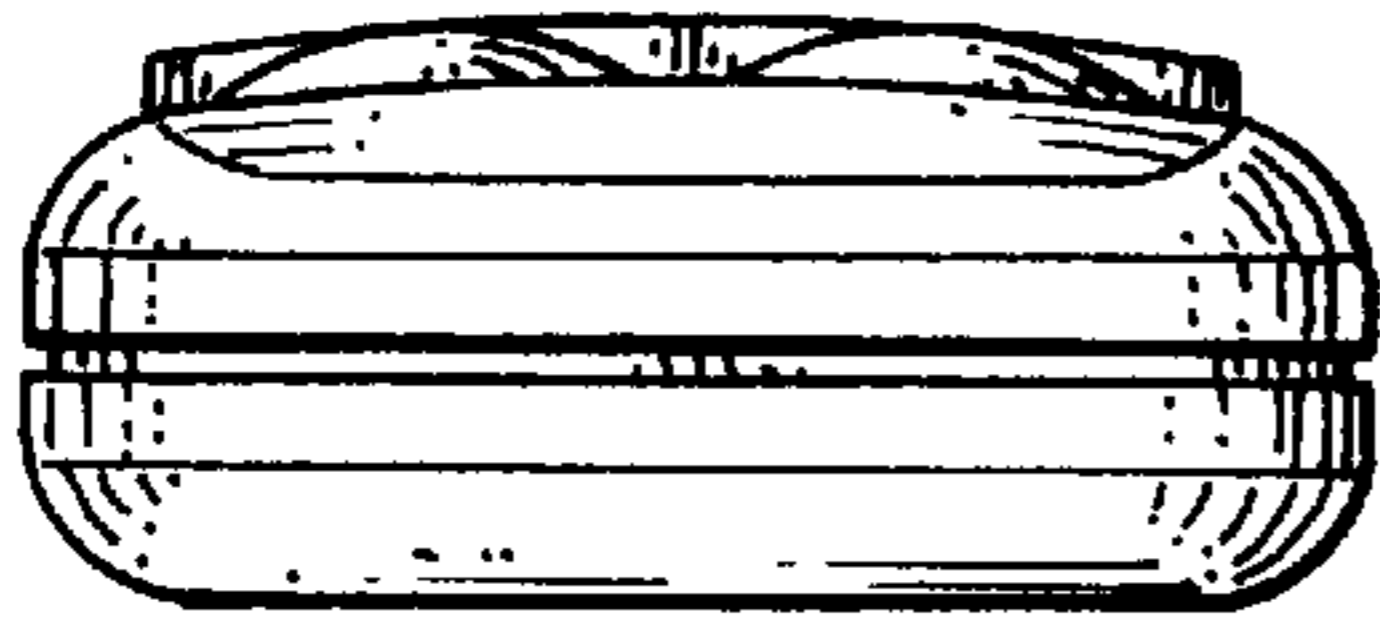
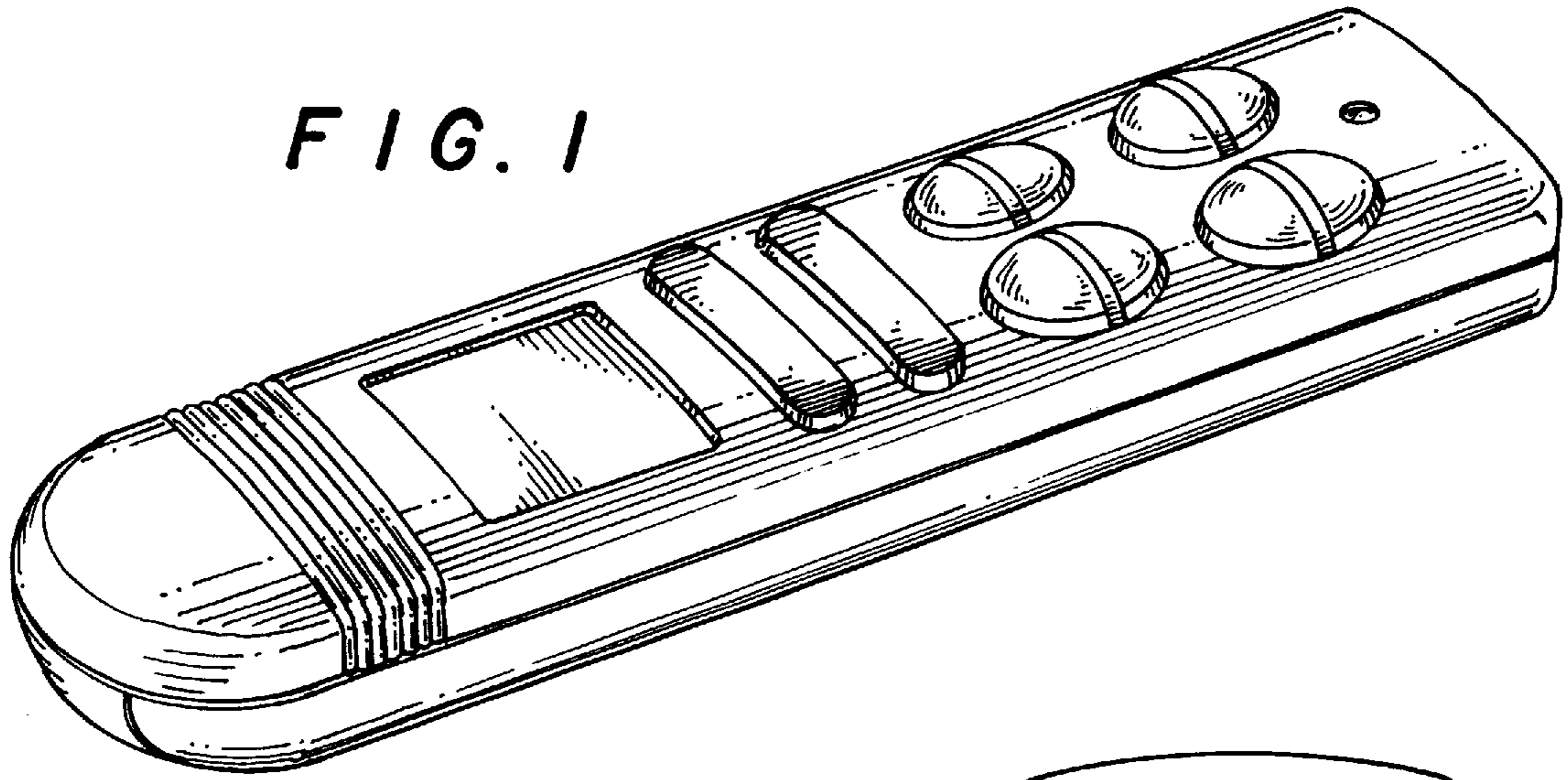

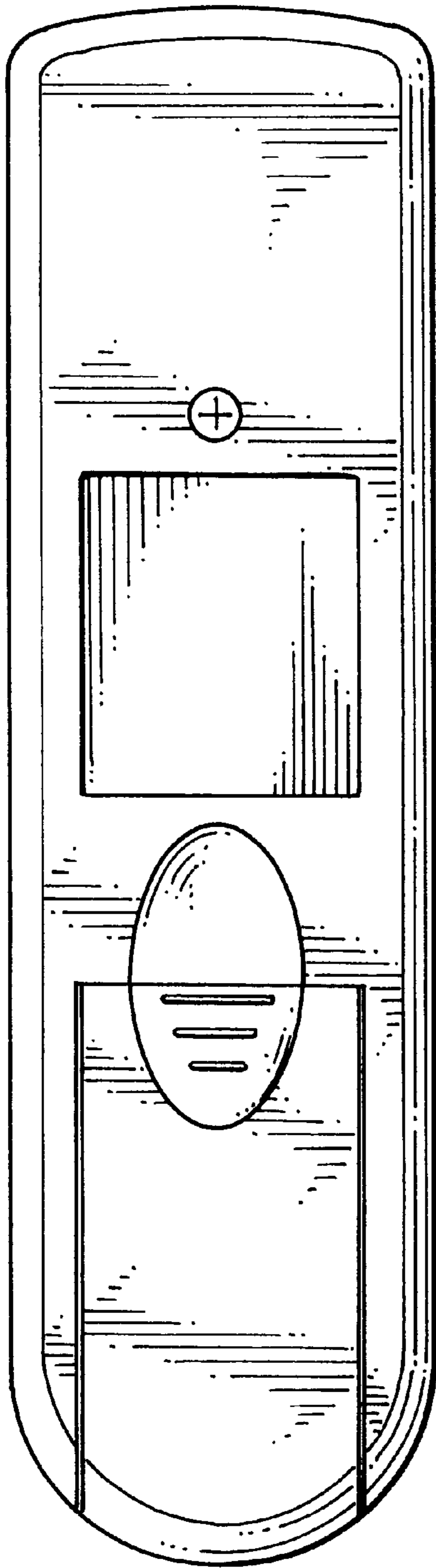

**FIG. 5**

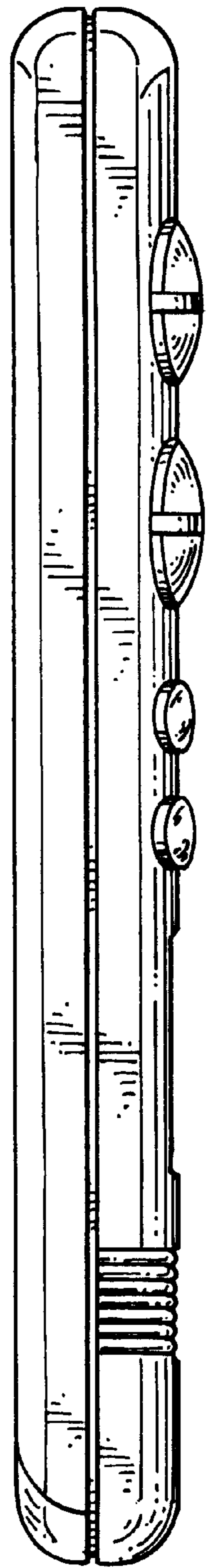

**FIG. 6**

UNITED STATES PATENT AND TRADEMARK OFFICE  
**CERTIFICATE OF CORRECTION**

PATENT NO. : d417,220  
DATED : November 30, 1999  
INVENTOR(S) : Godette et al.

Page 1 of 1

It is certified that error appears in the above-identified patent and that said Letters Patent is hereby corrected as shown below:

Item [75], please delete "Downey" in reference to Robert G. Godette, and insert --Midway City--.

Item [57], Claim, please delete "controller, as shown" and insert --controller as shown--.

Item [57], Description, in Fig. 5, please delete "and," and insert --and--.

Signed and Sealed this

Tenth Day of July, 2001

*Nicholas P. Godici*

*Attest:*

*Attesting Officer*

NICHOLAS P. GODICI

*Acting Director of the United States Patent and Trademark Office*