



US00D417212S

United States Patent [19] Oba

[11] Patent Number: Des. 417,212

[45] Date of Patent: ** Nov. 30, 1999

[54] CASE FOR SEMICONDUCTOR ELEMENT

[75] Inventor: Haruo Oba, Tokyo, Japan

[73] Assignee: Sony Corporation, Tokyo, Japan

[**] Term: 14 Years

[21] Appl. No.: 29/083,169

[22] Filed: Feb. 6, 1998

[30] Foreign Application Priority Data

Aug. 6, 1997 [JP] Japan 9-64177

[51] LOC (6) Cl. 14-99

[52] U.S. Cl. D14/120

[58] Field of Search D13/182, 184;
D14/120, 121; 206/308.1, 308.3; 369/75.1,
77.2, 272, 275.1, 275.2, 273.3, 280, 292

[56] References Cited

U.S. PATENT DOCUMENTS

D. 376,795 12/1996 Ashida D21/121
D. 381,977 8/1997 Nagata et al. D21/121
D. 396,228 7/1998 Yao D21/121
5,794,772 8/1998 Makinen et al. 206/308.1

OTHER PUBLICATIONS

“Power Shot 350 Digital Camara” Canon Mar. 1997.

“Picona” NEC PC-FH-01 Mar. 1997.

“DR-350” Kyocera Sep. 1997.

Primary Examiner—Brian N. Vinson

Attorney, Agent, or Firm—Foley & Lardner

[57] CLAIM

The ornamental design for a case for semiconductor element, as shown and described.

DESCRIPTION

FIG. 1 is a perspective view of a first embodiment of a case for semiconductor element showing my new design; FIG. 2 is a top plan view of the first embodiment; FIG. 3 is a left side elevational view thereof; FIG. 4 is a front elevational view thereof; FIG. 5 is a bottom plan view thereof; FIG. 6 is a right side elevational view thereof; FIG. 7 is a rear elevational view thereof; and FIG. 8 is a perspective view of the first embodiment, wherein the broken-line disclosure of the two inserted electronic components is for illustrative purposes only and forms no part of the claimed design; FIG. 9 is a perspective view of a second embodiment of a case for semiconductor element showing my new design; FIG. 10 is a top plan view of the second embodiment; FIG. 11 is a left side elevational view thereof; FIG. 12 is a front elevational view thereof; FIG. 13 is a bottom plan view thereof; FIG. 14 is a right side elevational view thereof; FIG. 15 is a rear elevational view thereof; and, FIG. 16 is a perspective view of the first embodiment, wherein the broken-line disclosure of the two inserted electronic components is for illustrative purposes only and forms no part of the claimed design.

1 Claim, 8 Drawing Sheets

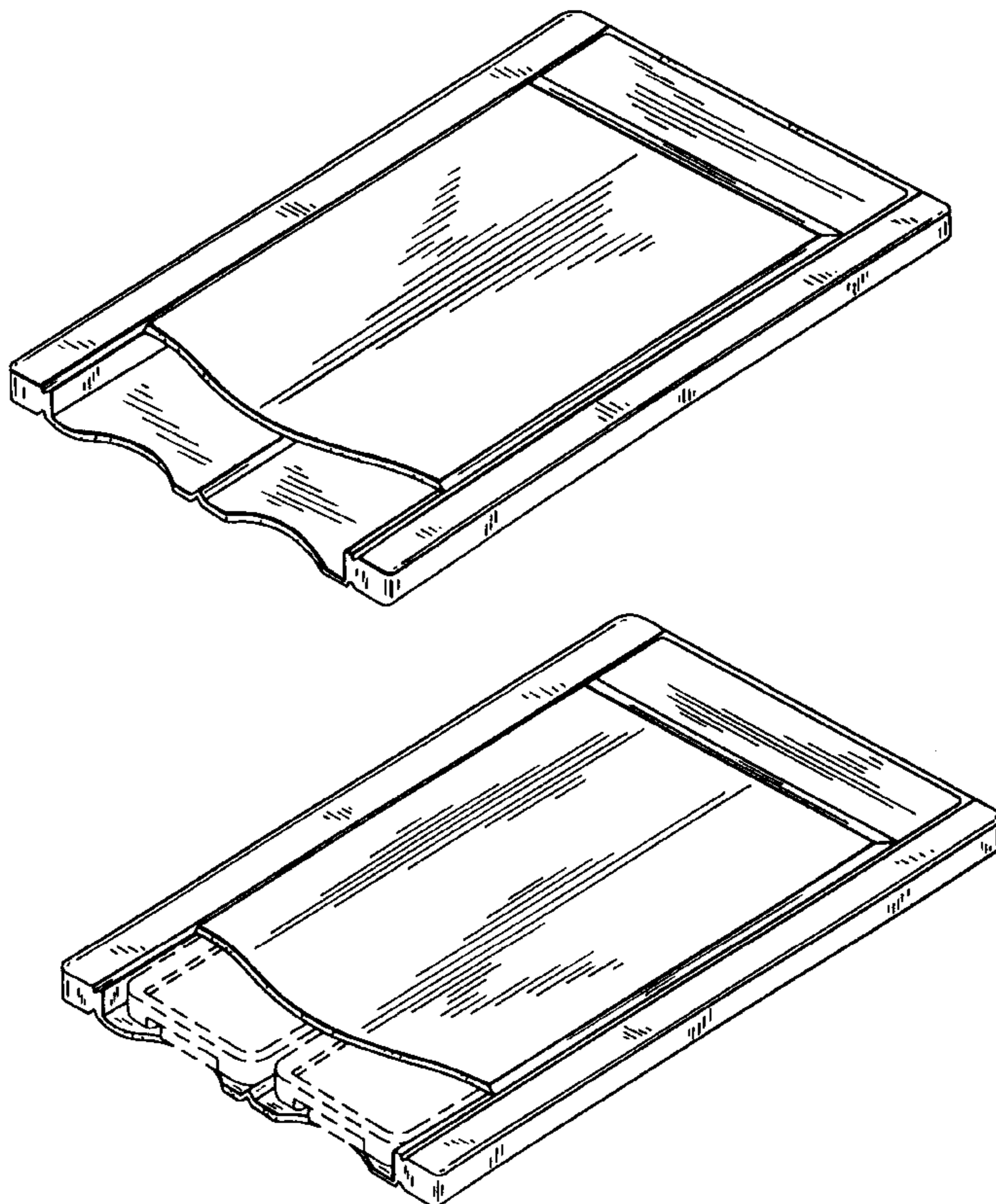

FIG. 1

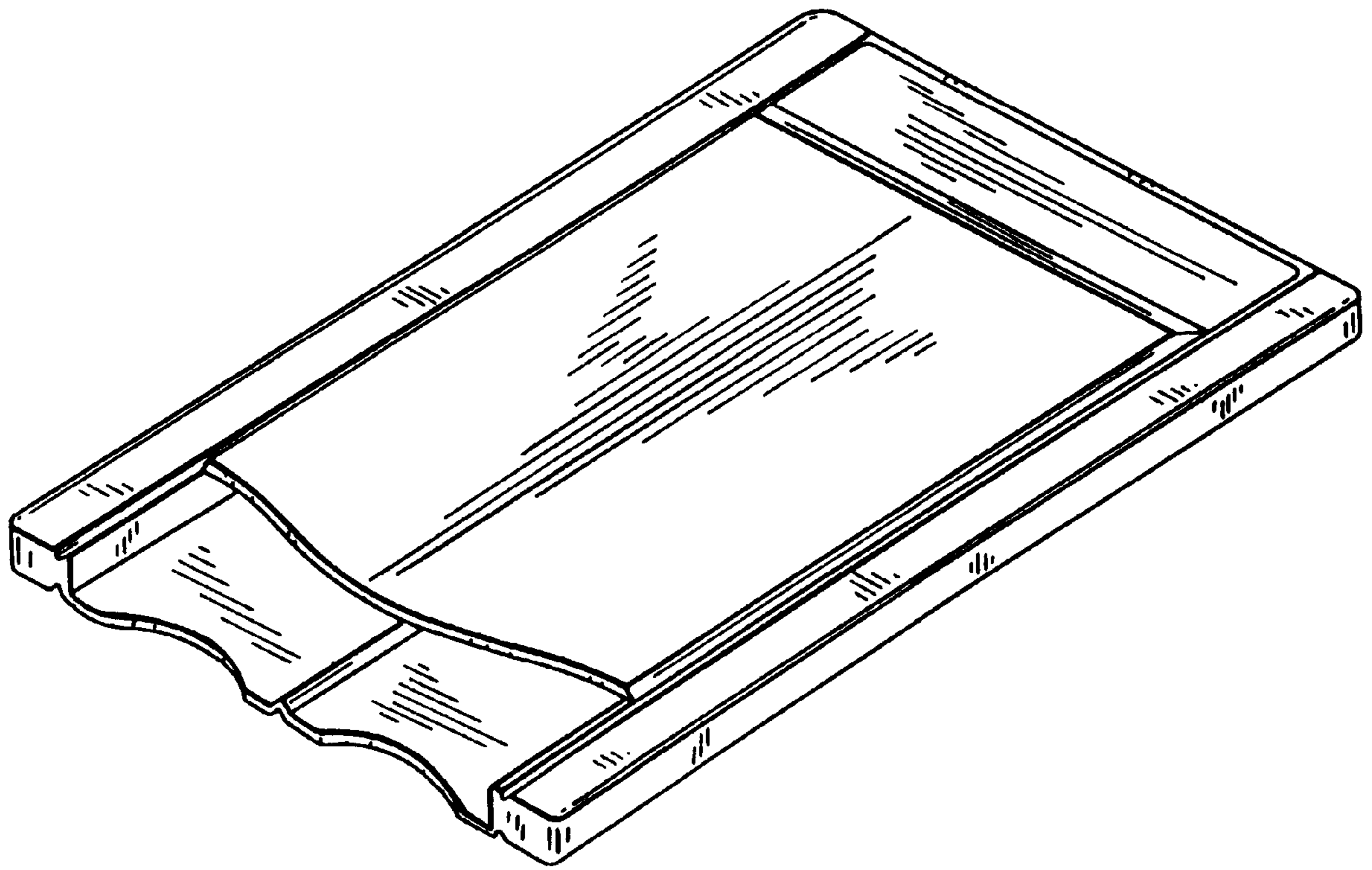

FIG. 2



FIG. 3



FIG. 4

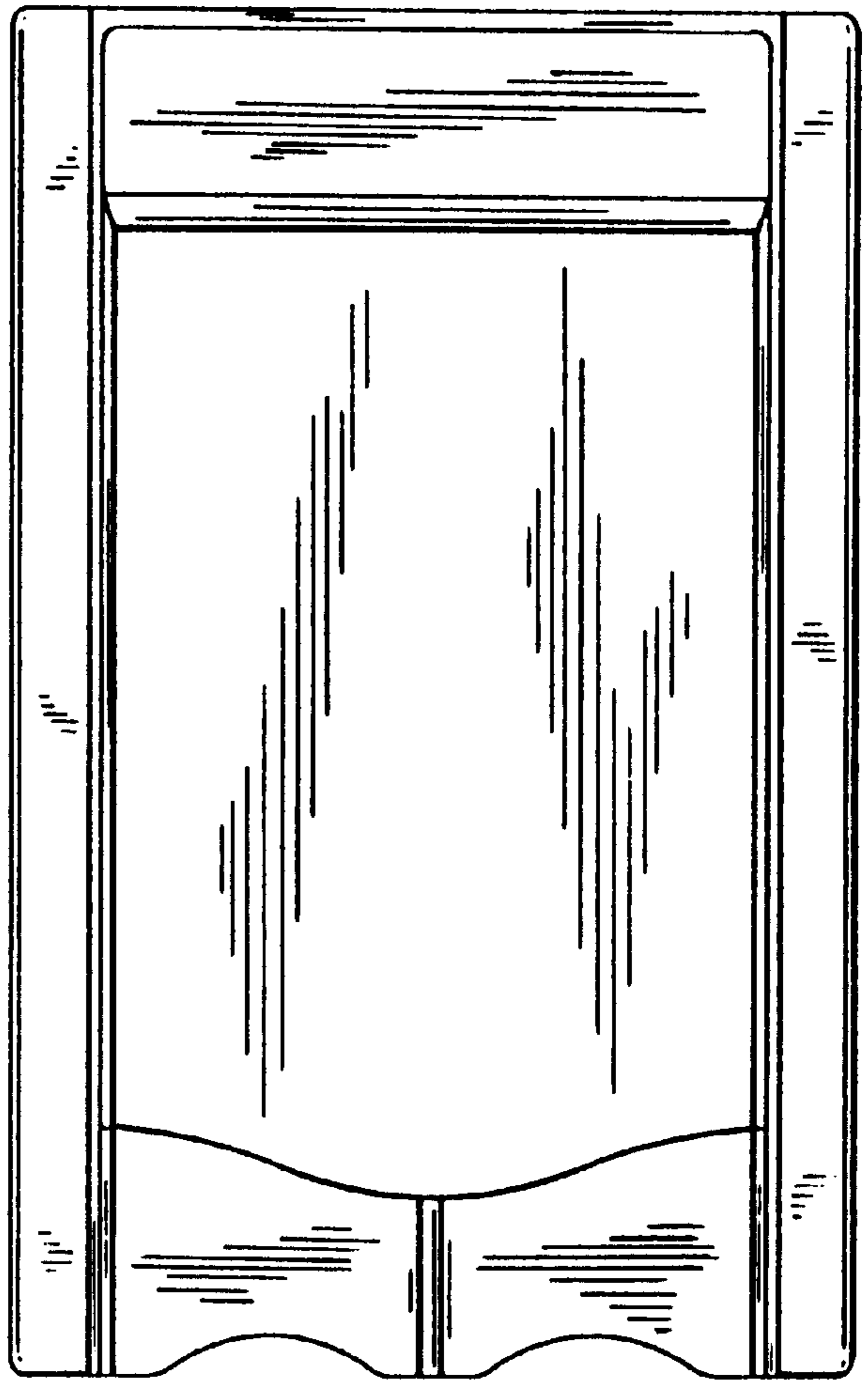

FIG. 5



FIG. 6

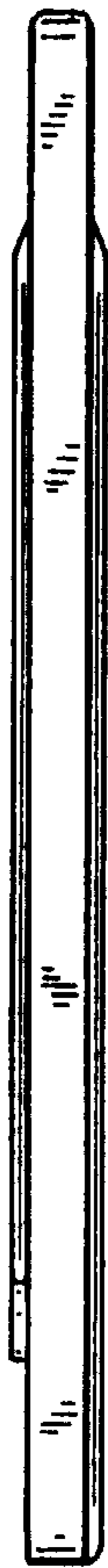

FIG. 7

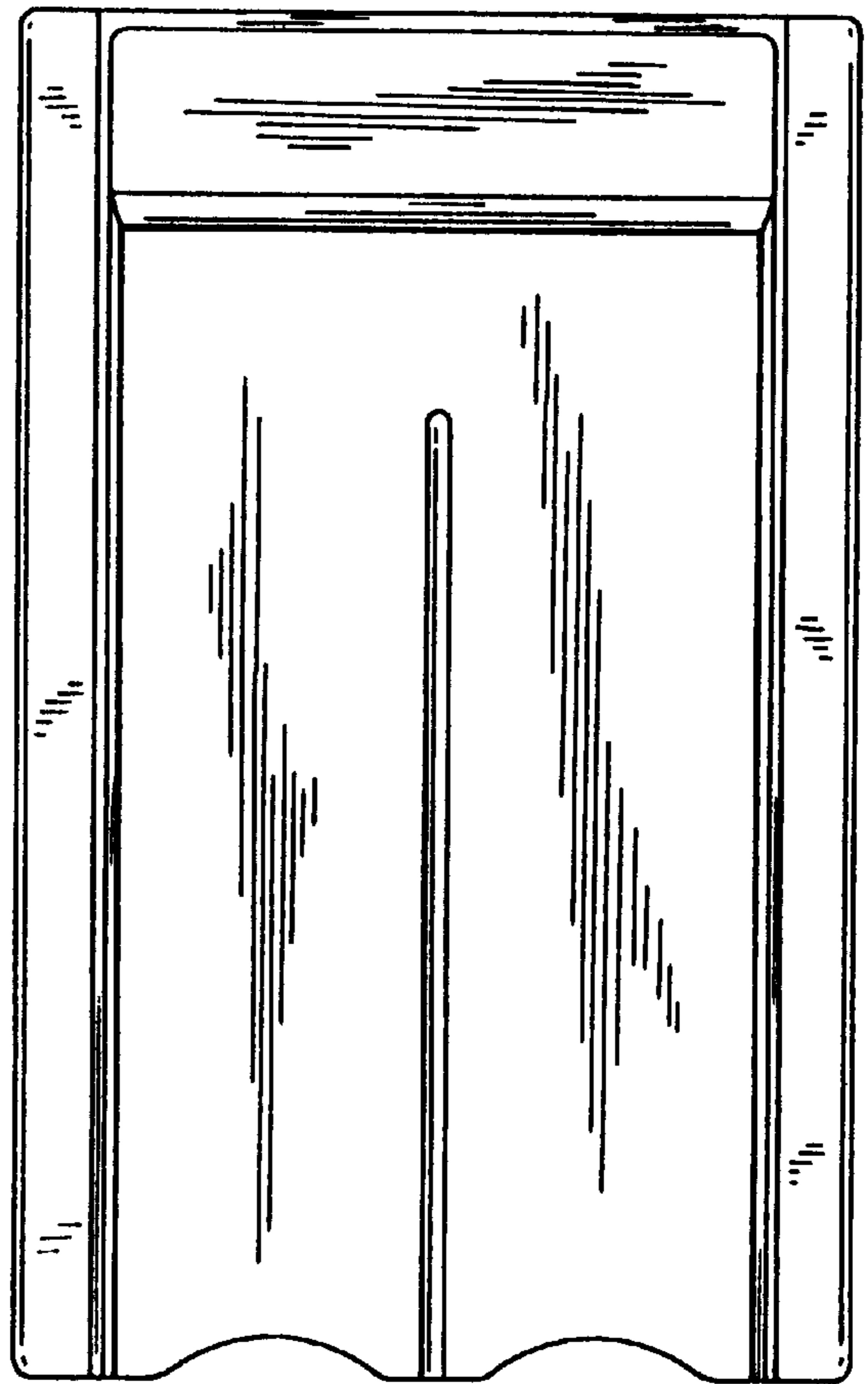

FIG. 8

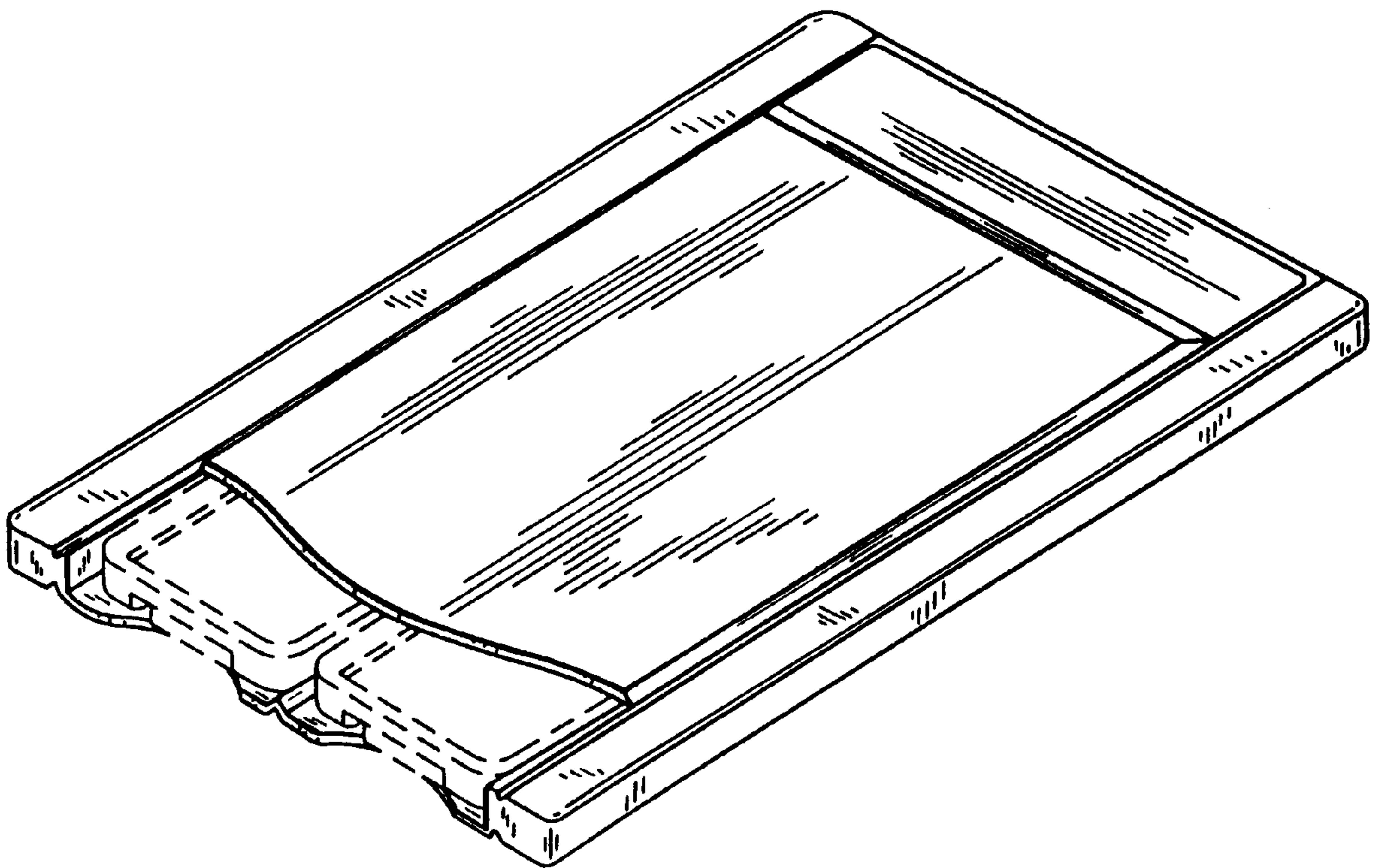

FIG. 9

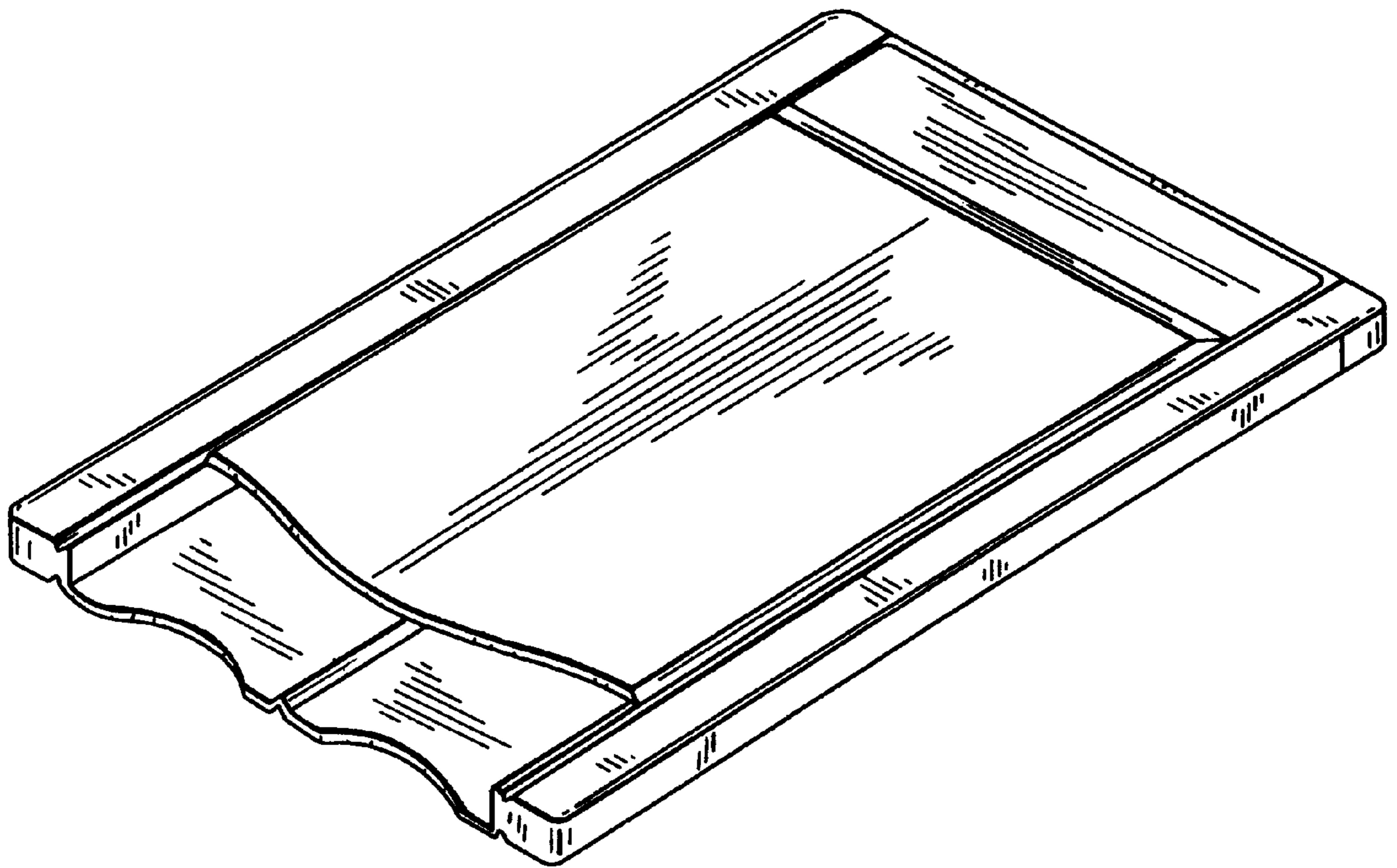

FIG. 10



FIG. 11



FIG. 12

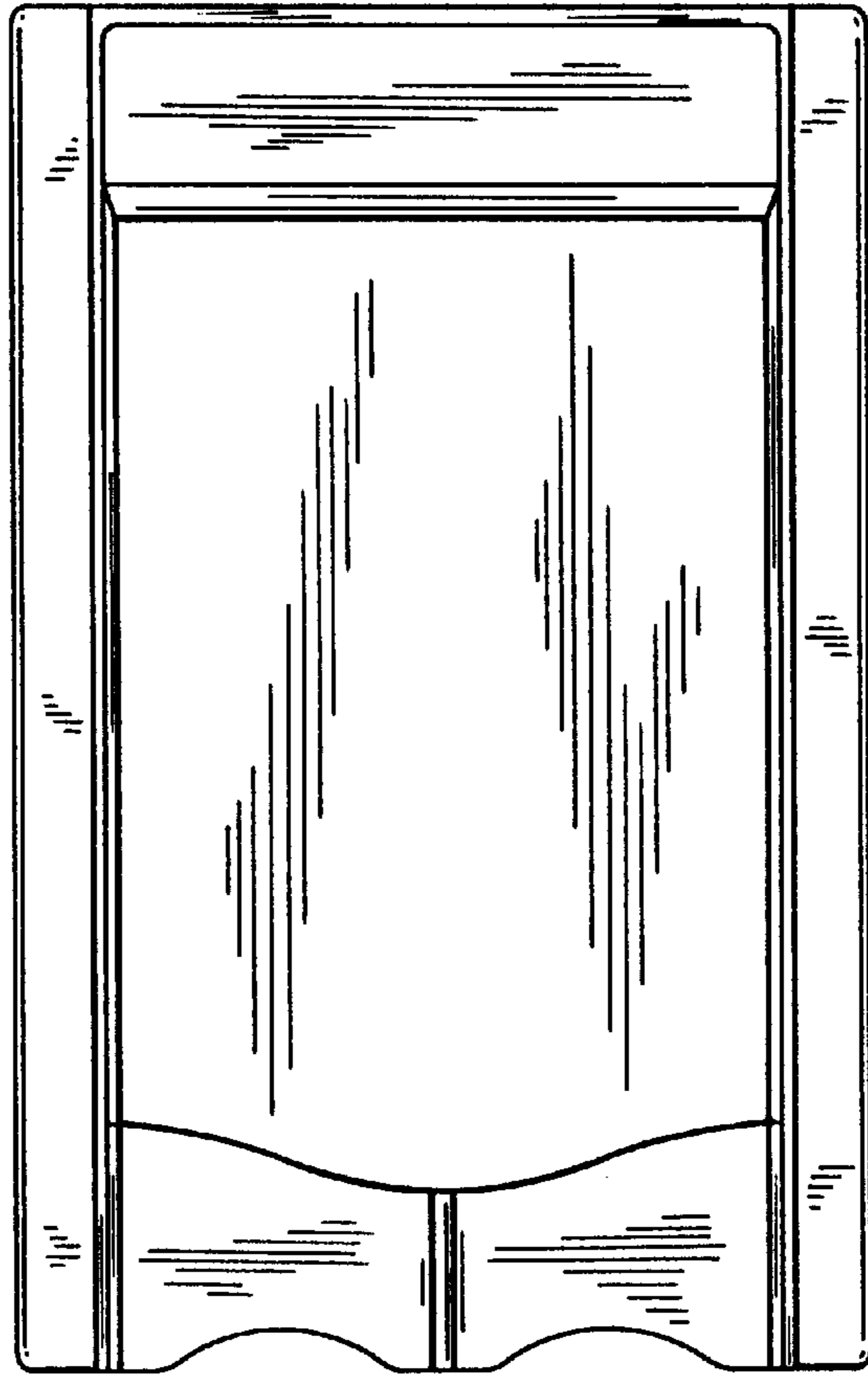

FIG. 13



FIG. 14

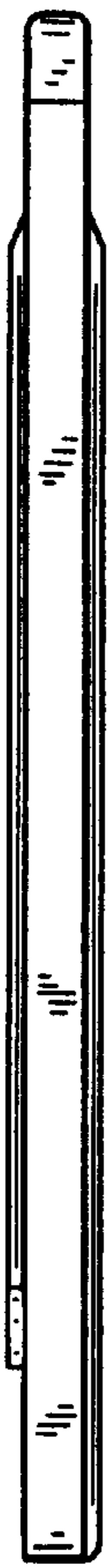

FIG. 15

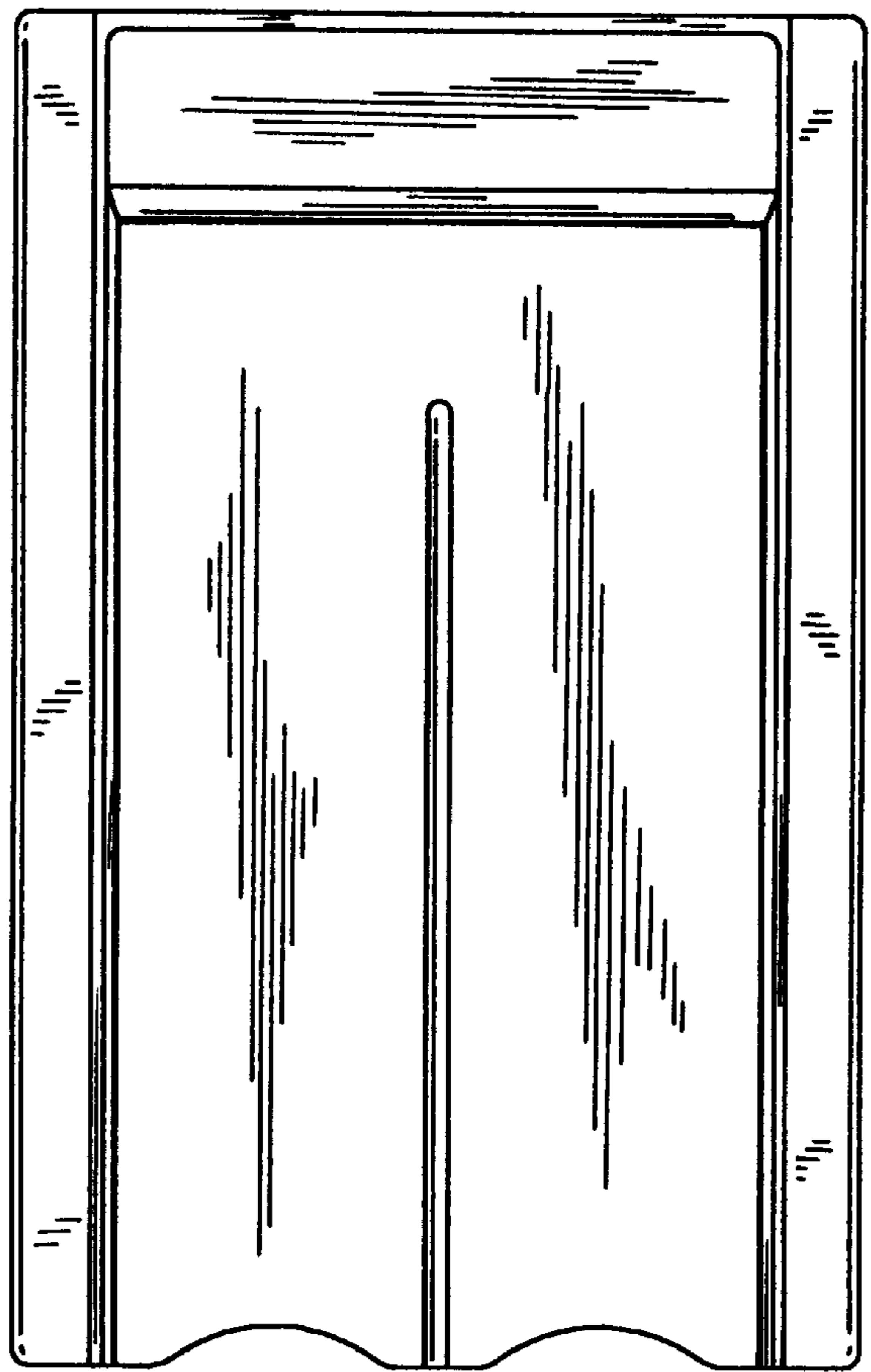

FIG. 16

