



US00D417136S

United States Patent [19] Jackovin

[11] Patent Number: Des. 417,136

[45] Date of Patent: ** Nov. 30, 1999

[54] HOSE CLIP

[75] Inventor: Gary B. Jackovin, Ankeny, Iowa

[73] Assignee: Maytag Corporation, Newton, Iowa

[**] Term: 14 Years

[21] Appl. No.: 29/070,922

[22] Filed: May 12, 1997

[51] LOC (6) Cl. 08-08

[52] U.S. Cl. D8/356

[58] Field of Search D8/356, 382, 394;
D9/455; D6/466-467, 469; D23/265; 24/16 PB,
115 A, 115 R, 457, 570; 248/73, 74.2, 68.1,
126, 316.7, 75, 79

[56] **References Cited**

U.S. PATENT DOCUMENTS

1,308,869	7/1919	Rohmer	248/69
2,495,848	1/1950	Kiesel	248/68.1
3,090,826	5/1963	Cochran	174/158 R
3,747,166	7/1973	Eross	248/75
4,027,842	6/1977	Mittleman	248/75
4,042,198	8/1977	Takeuchi	248/62
4,151,864	5/1979	Thurman	.

4,163,457	8/1979	Rickel et al.	.
4,279,396	7/1981	Bendock	248/205.5
4,318,519	3/1982	Blevins	.
5,082,225	1/1992	Nespoli	248/231.81
5,489,078	2/1996	Risley	248/231.81

Primary Examiner—Alan P. Douglas
Assistant Examiner—Reid Hecker
Attorney, Agent, or Firm—Zarley,McKee,Thomte,Voorhees & Sease

[57] **CLAIM**

I claim the ornamental design for a hose clip, as shown and described.

DESCRIPTION

FIG. 1 is a perspective view of the hose clip of the present invention.
FIG. 2 is a front elevational view thereof.
FIG. 3 is a rear elevational view thereof.
FIG. 4 is a top plan view thereof.
FIG. 5 is a bottom plan view thereof.
FIG. 6 is a side elevational view thereof as viewed from the right of FIG 2; and,
FIG. 7 is a side elevational view thereof taken from the left of FIG. 2.

1 Claim, 1 Drawing Sheet

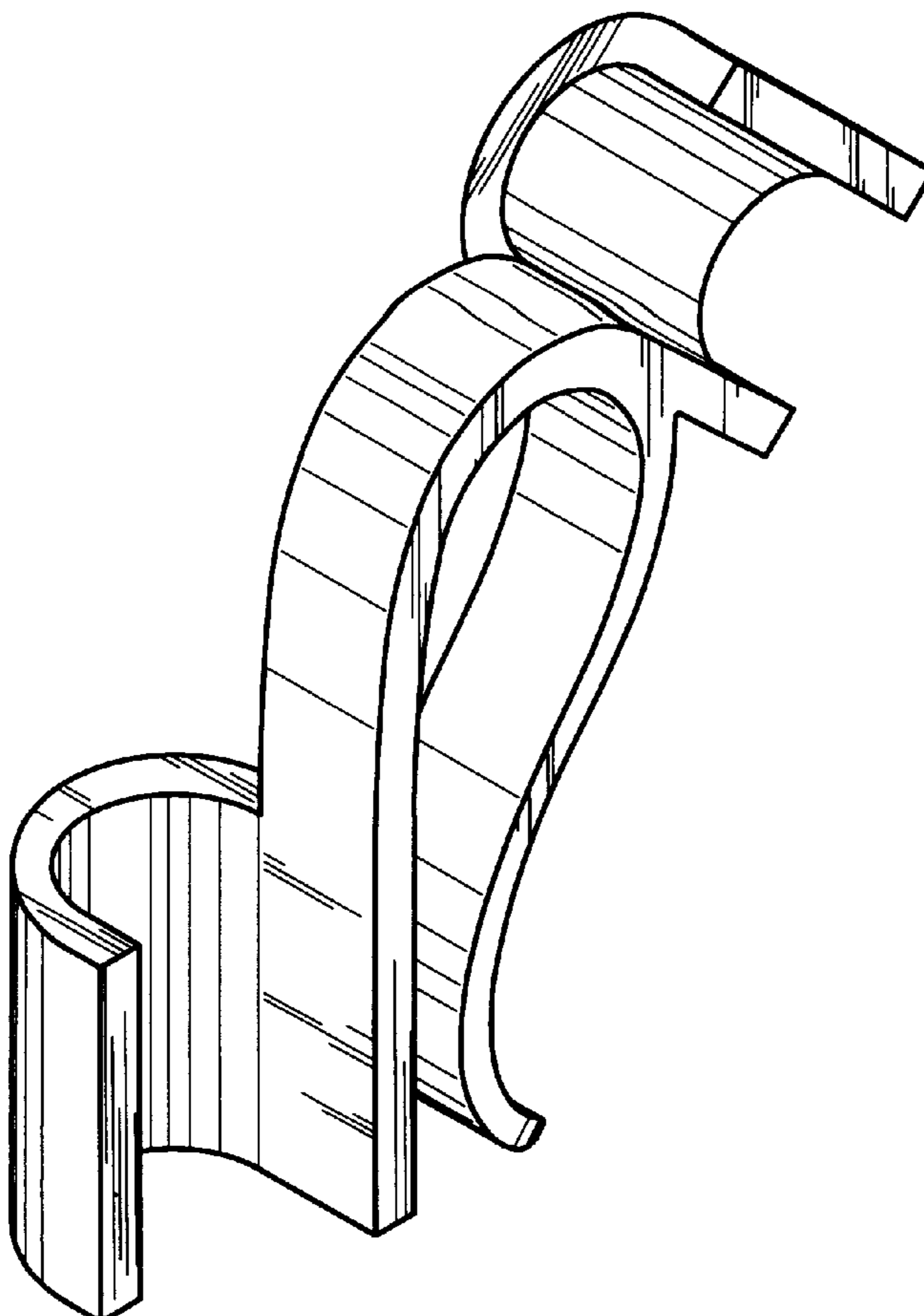

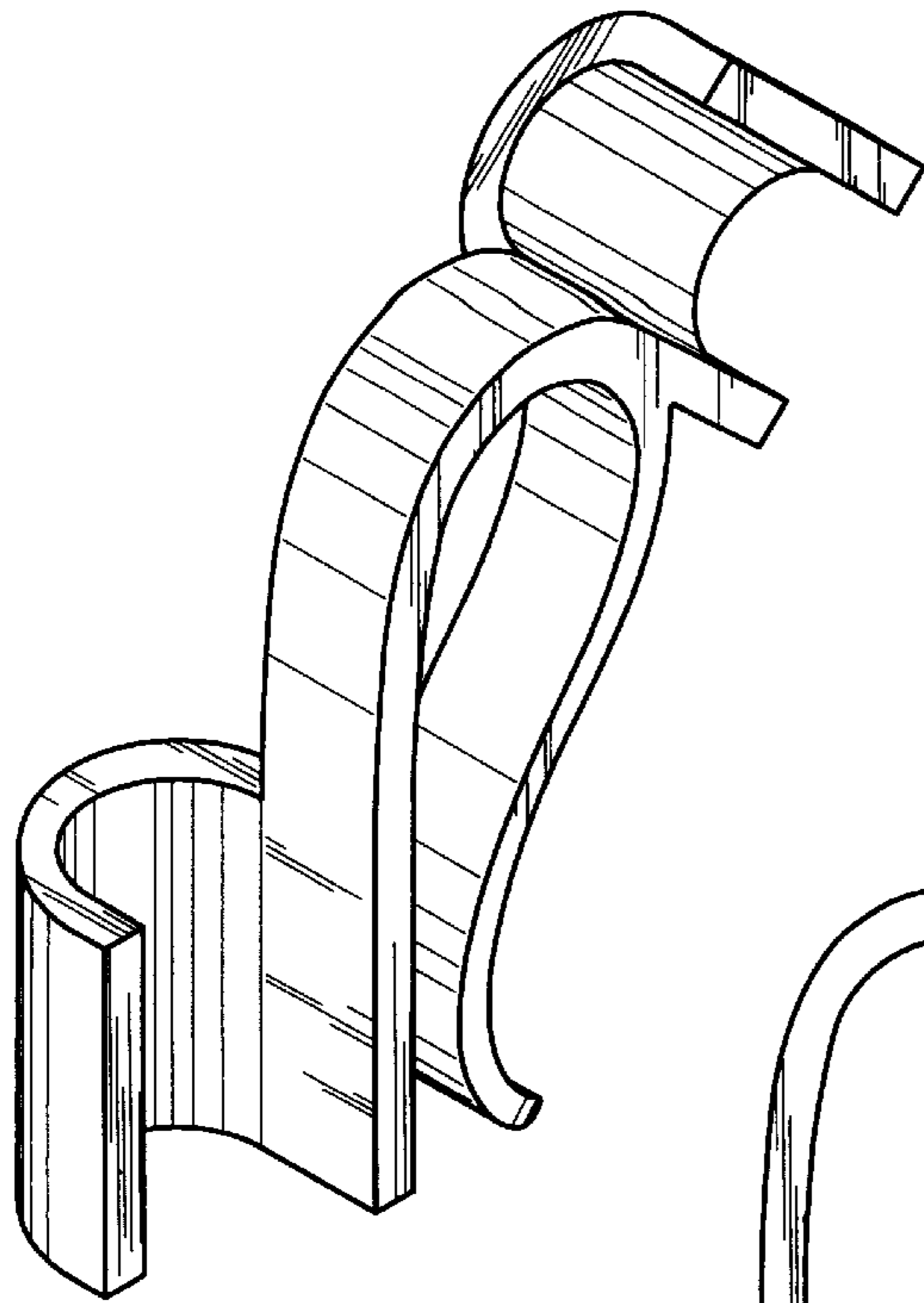

Fig. 1

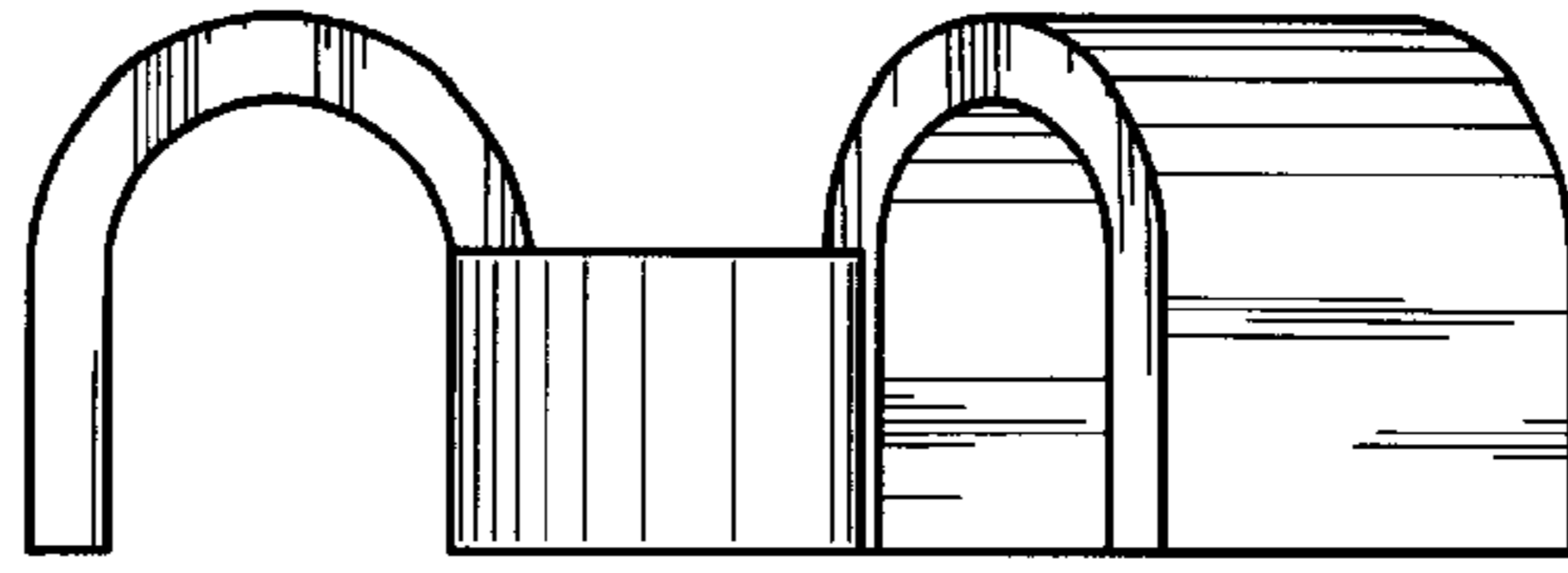

Fig. 4

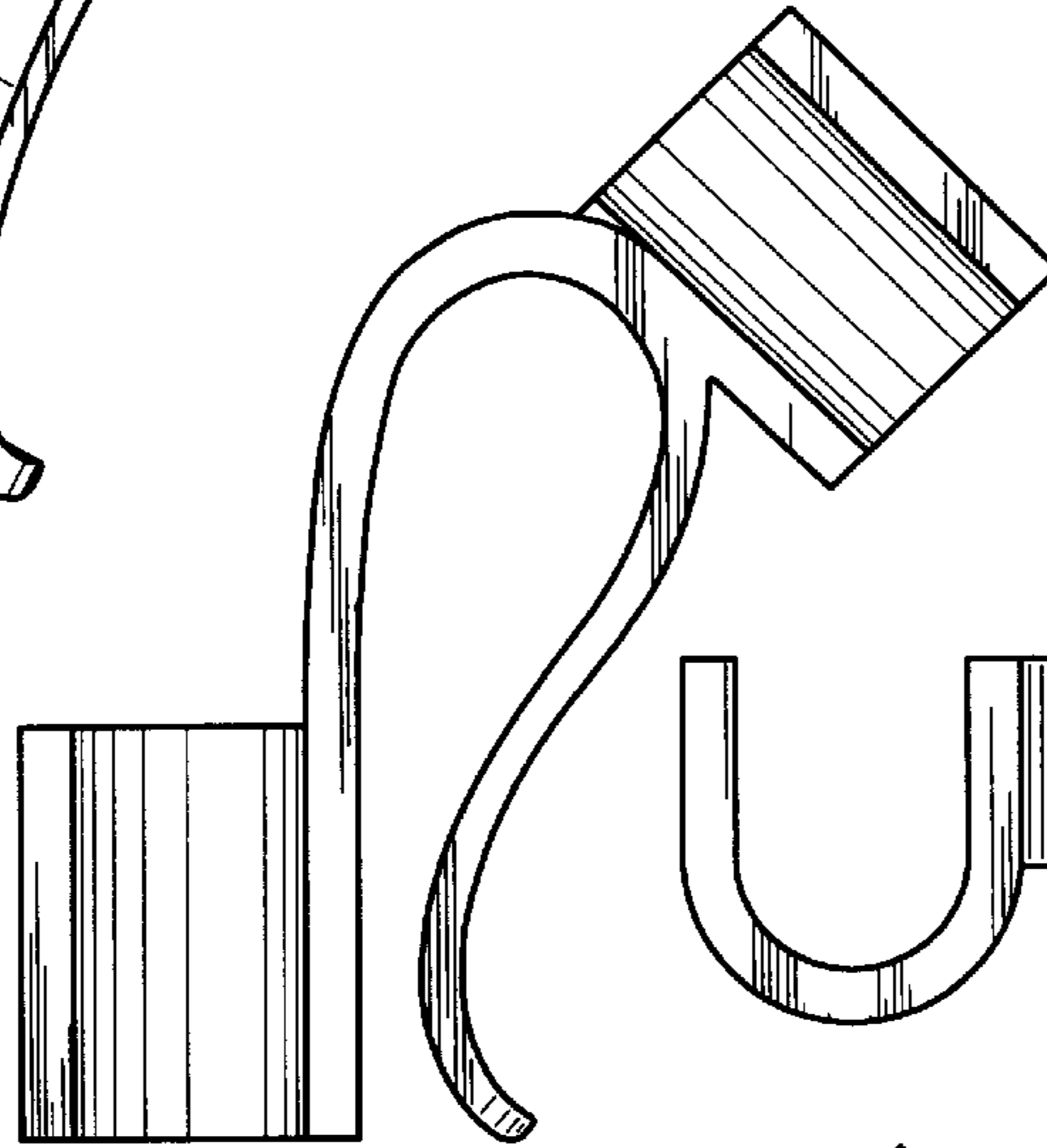

Fig. 2

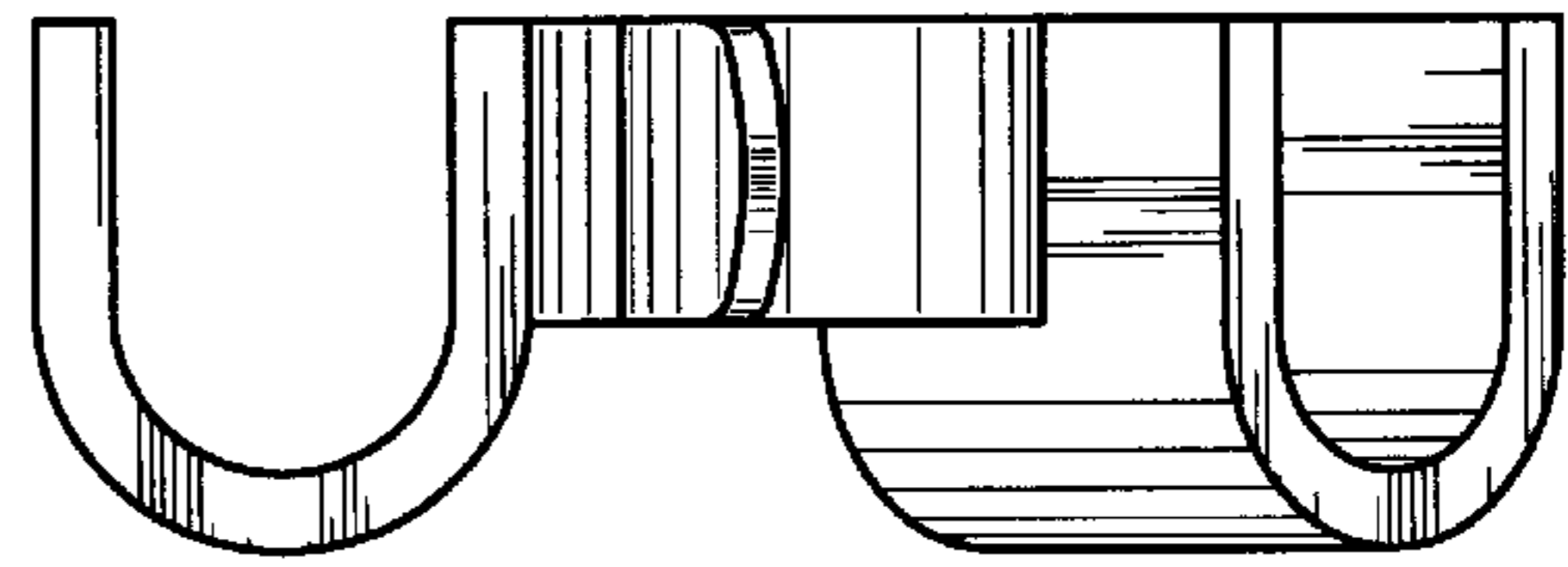

Fig. 5

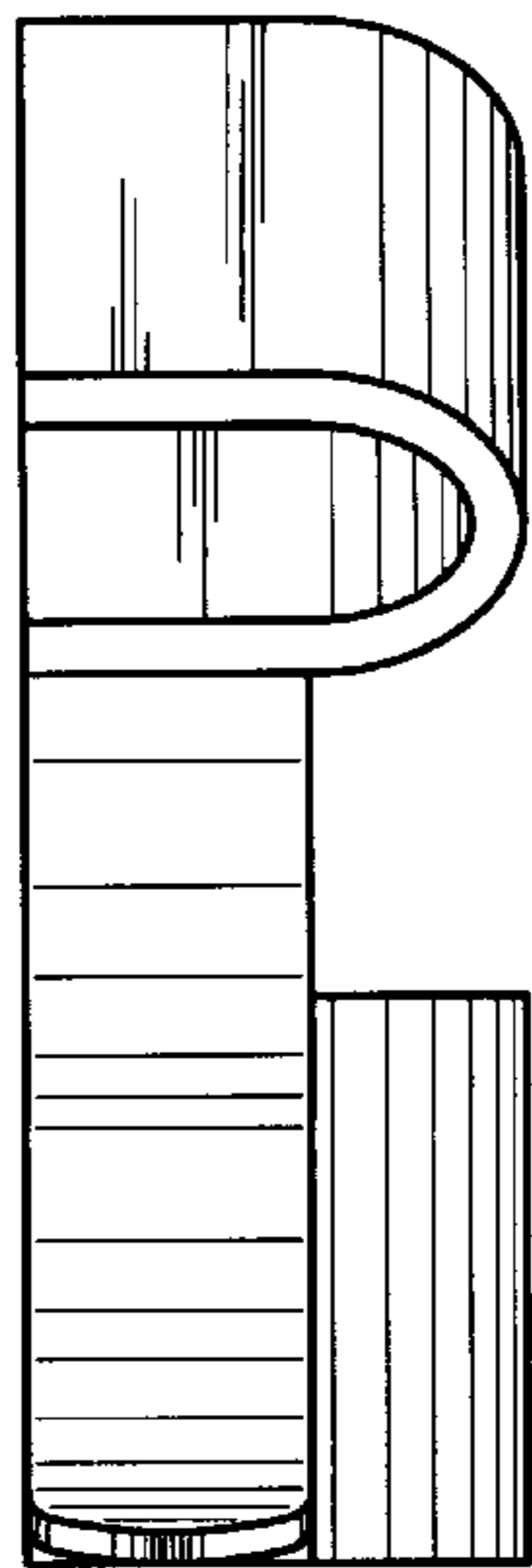

Fig. 6

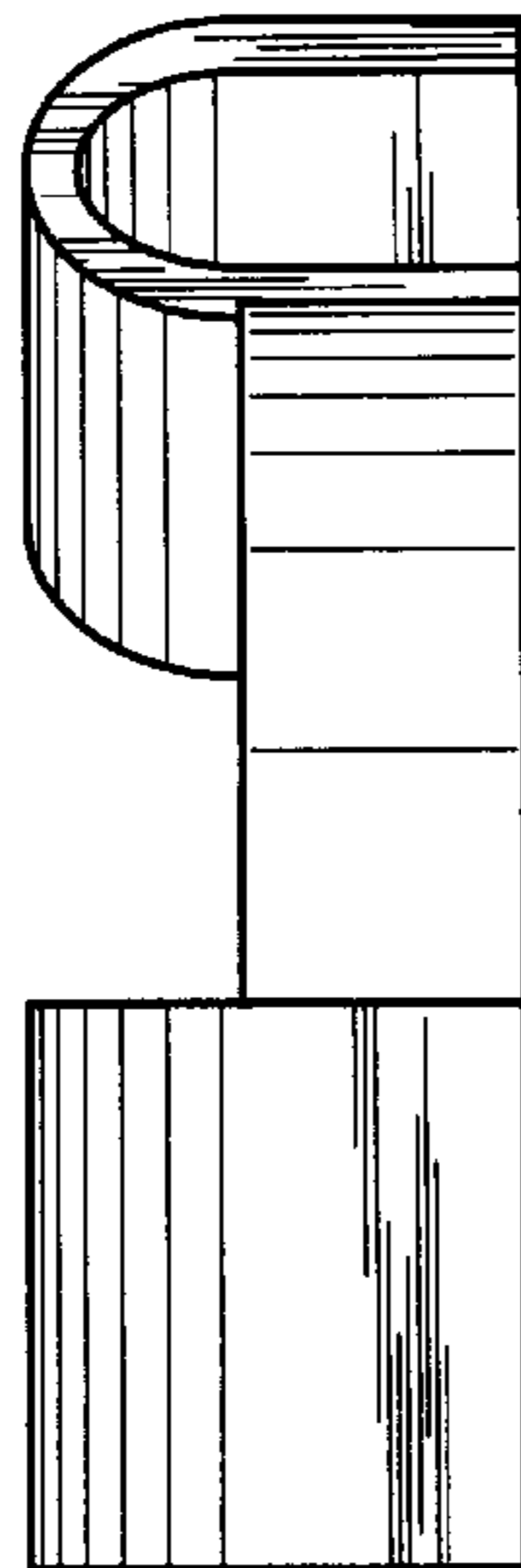

Fig. 7

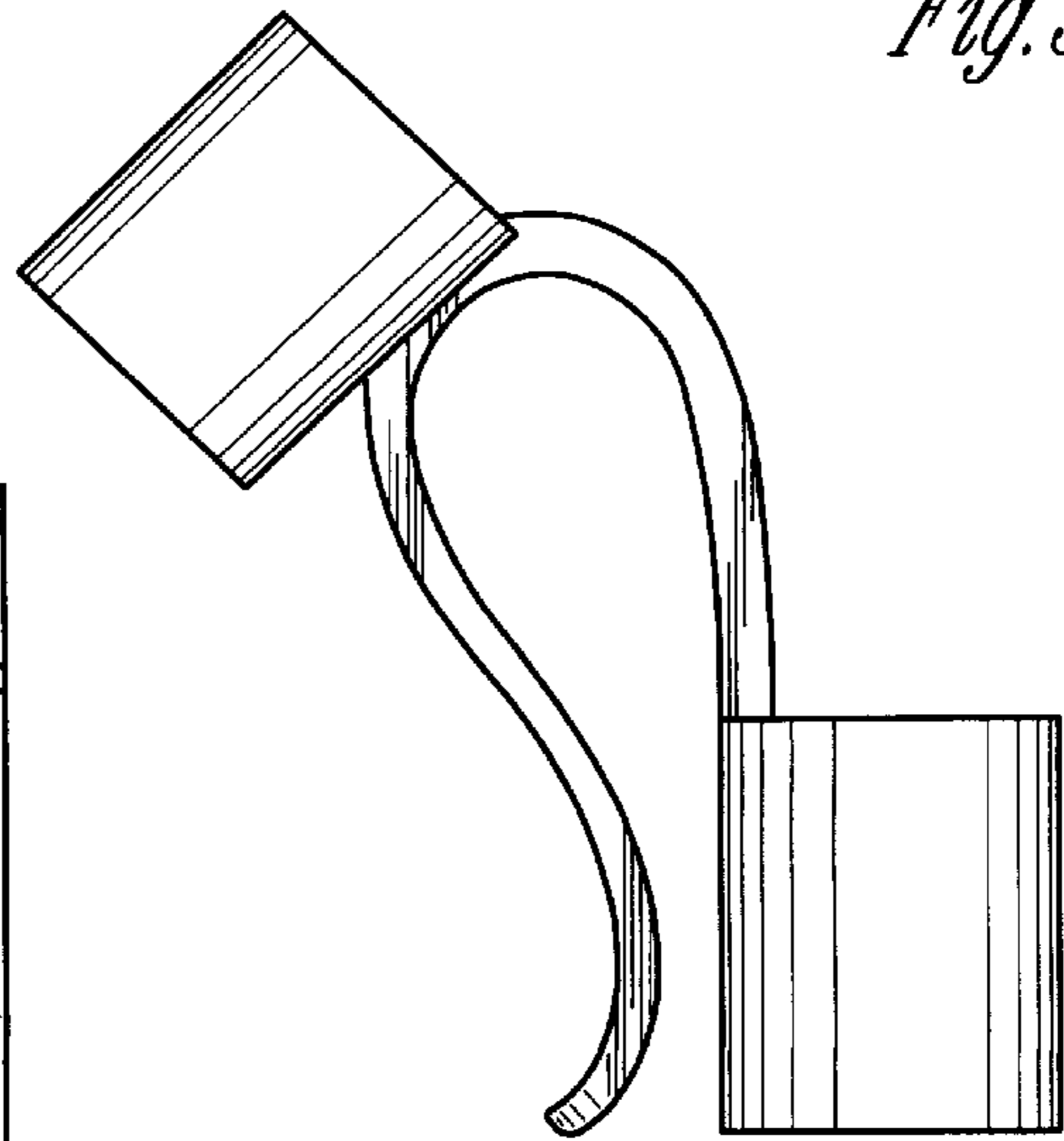

Fig. 3