



US00D417075S

# United States Patent [19]

[11] Patent Number: Des. 417,075

Baxter et al.

[45] Date of Patent: \*\* Nov. 30, 1999

## [54] SLEEVE FOR GOLF BALLS

[75] Inventors: **Brooke T. Baxter**, Sherman, Conn.;  
**Philippe Besnard**; **Dean A. Snell**, both  
of Oceanside, Calif.; **Todd B. Colburn**,  
Solana Beach, Calif.

[73] Assignee: **Taylor Made Golf Company, Inc.**,  
Carlsbad, Calif.

[\*\*] Term: **14 Years**

[21] Appl. No.: **29/099,167**

[22] Filed: **Jan. 14, 1999**

[51] LOC (6) Cl. .... **03-01**

[52] U.S. Cl. .... **D3/257**

[58] Field of Search ..... D3/254, 221, 257;  
224/918, 919; 206/315.9, 315.1; D9/430,  
424

## [56] References Cited

### U.S. PATENT DOCUMENTS

D. 291,842	9/1987	Baumgardner .....	D3/254
D. 369,972	5/1996	Solheim .....	D3/257 X
D. 375,406	11/1996	Smith .....	D3/257
D. 394,154	5/1998	Smith .....	D3/257
1,050,706	1/1913	Taylor .	
1,421,955	7/1922	Kemp .	
3,819,040	6/1974	Coons .	
4,258,847	3/1981	Nierman .	
4,553,667	11/1985	Hudson et al. .	
5,433,491	7/1995	Green .	
5,511,666	4/1996	Grip .	
5,641,064	6/1997	Goserud .	
5,730,286	3/1998	Eska .....	206/315.9

*Primary Examiner*—Louis S. Zarfaz

*Assistant Examiner*—Catherine R. Oliver

*Attorney, Agent, or Firm*—Knobbe, Martens, Olson & Bear,  
LLP

## [57] CLAIM

The ornamental design for a sleeve for golf balls, as shown.

### DESCRIPTION

FIG. 1 is a side perspective view of the sleeve for golf balls showing a first embodiment of the present invention;

FIG. 2 is a front view of the sleeve for golf balls of FIG. 1; FIG. 3 is a rear view of the sleeve for golf balls of FIG. 1; FIG. 4 is a top perspective view of the sleeve for golf balls of FIG. 1;

FIG. 5 is a top view of the sleeve for golf balls of FIG. 1; FIG. 6 is a bottom view of the sleeve for golf balls of FIG. 1;

FIG. 7 is a left side view of the sleeve for golf balls of FIG. 1;

FIG. 8 is a right side view of the sleeve for golf balls of FIG. 1;

FIG. 9 is a partial sectional view of the sleeve for golf balls of FIG. 1 taken along line 9—9 of FIG. 1;

FIG. 10 is a cross-sectional view of the sleeve for golf balls of FIG. 1 taken along line 10—10 of FIG. 2;

FIG. 11 is a side perspective view of the sleeve for golf balls showing a second embodiment of the present invention;

FIG. 12 is a front view of the sleeve for golf balls of FIG. 11;

FIG. 13 is a rear view of the sleeve for golf balls of FIG. 11;

FIG. 14 is a top perspective view of the sleeve for golf balls of FIG. 11;

FIG. 15 is a top view of the sleeve for golf balls of FIG. 11; FIG. 16 is a bottom view of the sleeve for golf balls of FIG. 11;

FIG. 17 is a left side view of the sleeve for golf balls of FIG. 11;

FIG. 18 is a right side view of the sleeve for golf balls of FIG. 11;

FIG. 19 is a partial sectional view of the sleeve for golf balls of FIG. 11 taken along line 19—19 of FIG. 11;

FIG. 20 is a cross-sectional view of the sleeve for golf balls of FIG. 11 taken along line 20—20 of FIG. 12;

FIG. 21 is a side perspective view of the sleeve for golf balls showing a third embodiment of the present invention;

FIG. 22 is a front view of the sleeve for golf balls of FIG. 21;

FIG. 23 is a rear view of the sleeve for golf balls of FIG. 21;

FIG. 24 is a top perspective view of the sleeve for golf balls of FIG. 21;

FIG. 25 is a top view of the sleeve for golf balls of FIG. 21; FIG. 26 is a bottom view of the sleeve for golf balls of FIG. 21;

FIG. 27 is a left side view of the sleeve for golf balls of FIG. 21;

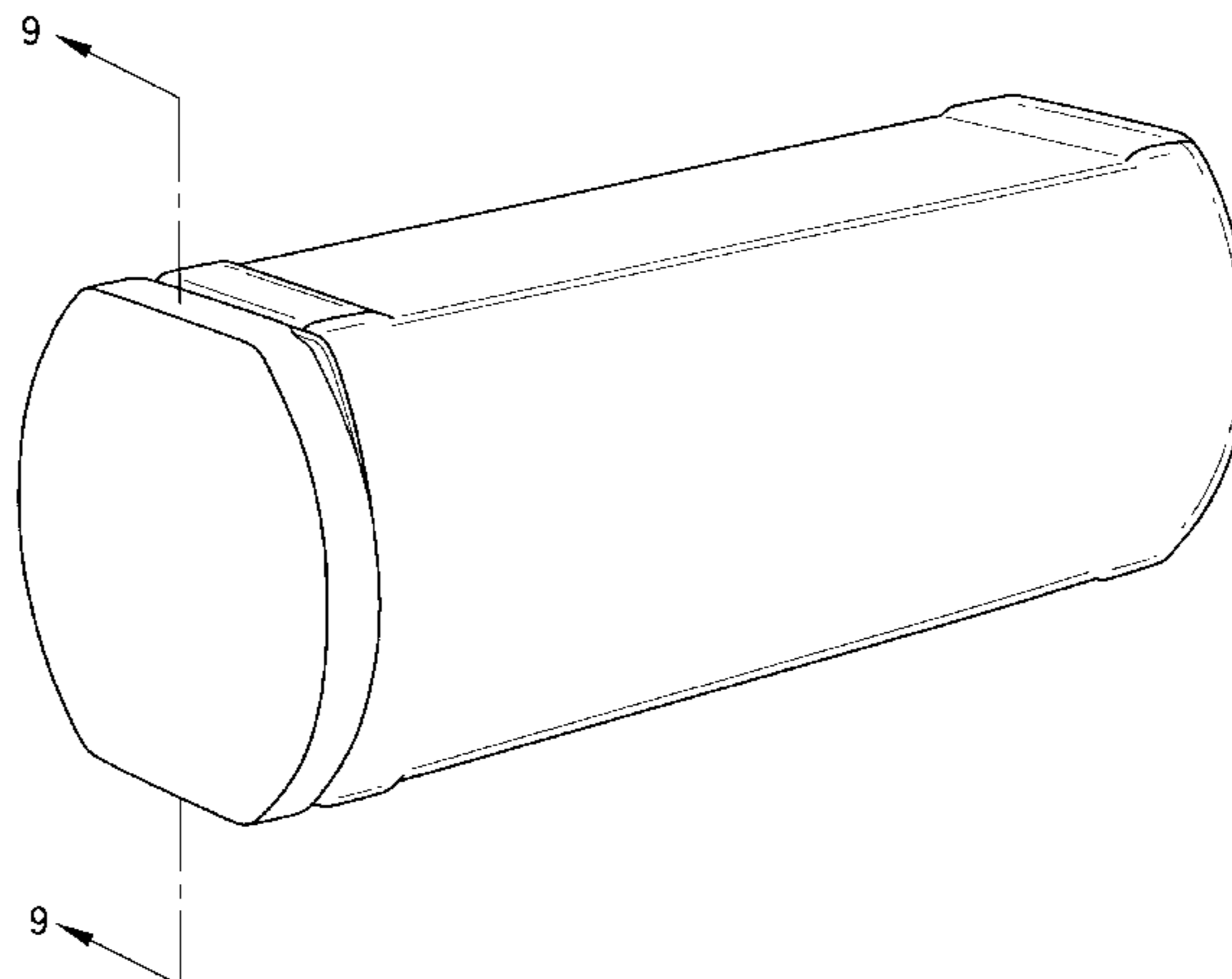

FIG. 28 is a right side view of the sleeve for golf balls of FIG. 21;

FIG. 29 is a partial sectional view of the sleeve for golf balls of FIG. 21 taken along line 29—29 of FIG. 21; and,

FIG. 30 is a cross-sectional view of the sleeve for golf balls of FIG. 21 taken along line 30—30 of FIG. 22.

**1 Claim, 30 Drawing Sheets**

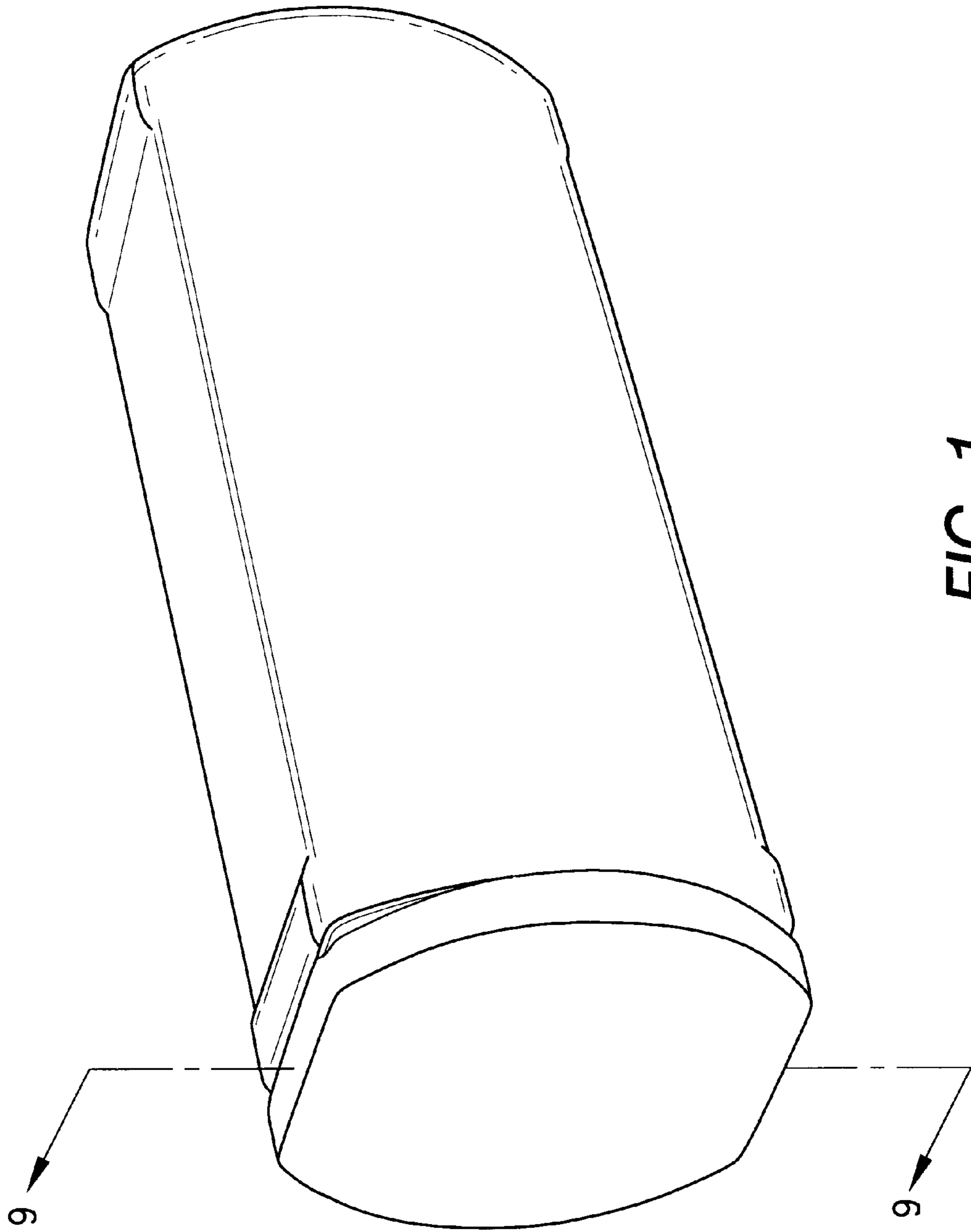

FIG. 1

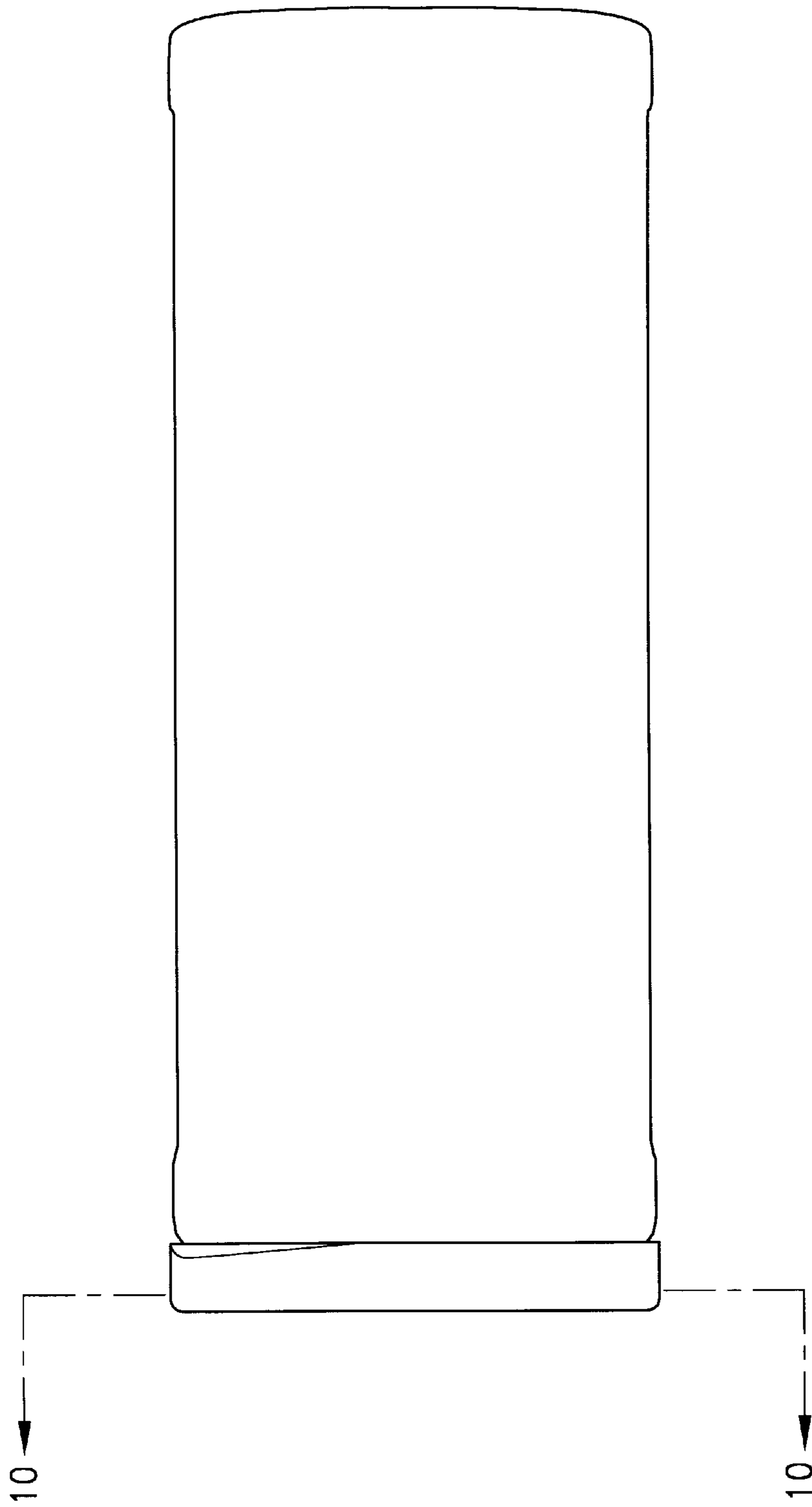

FIG. 2

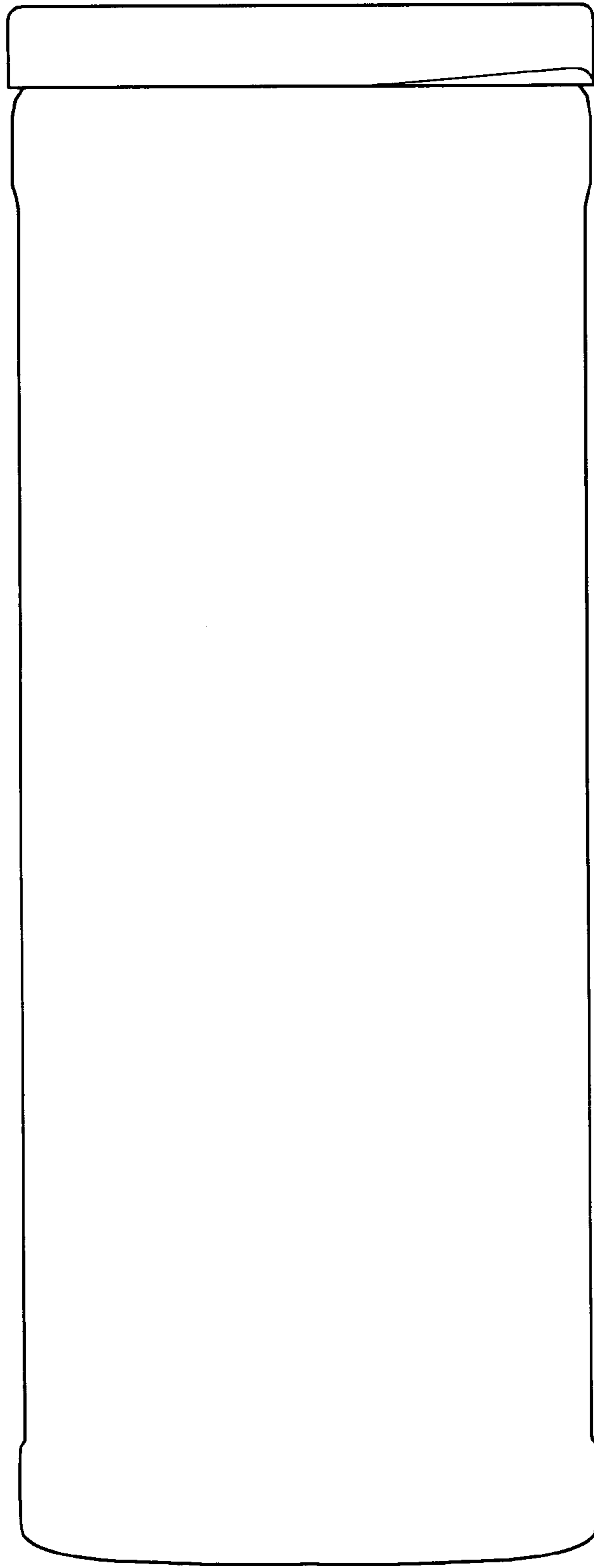

FIG. 3

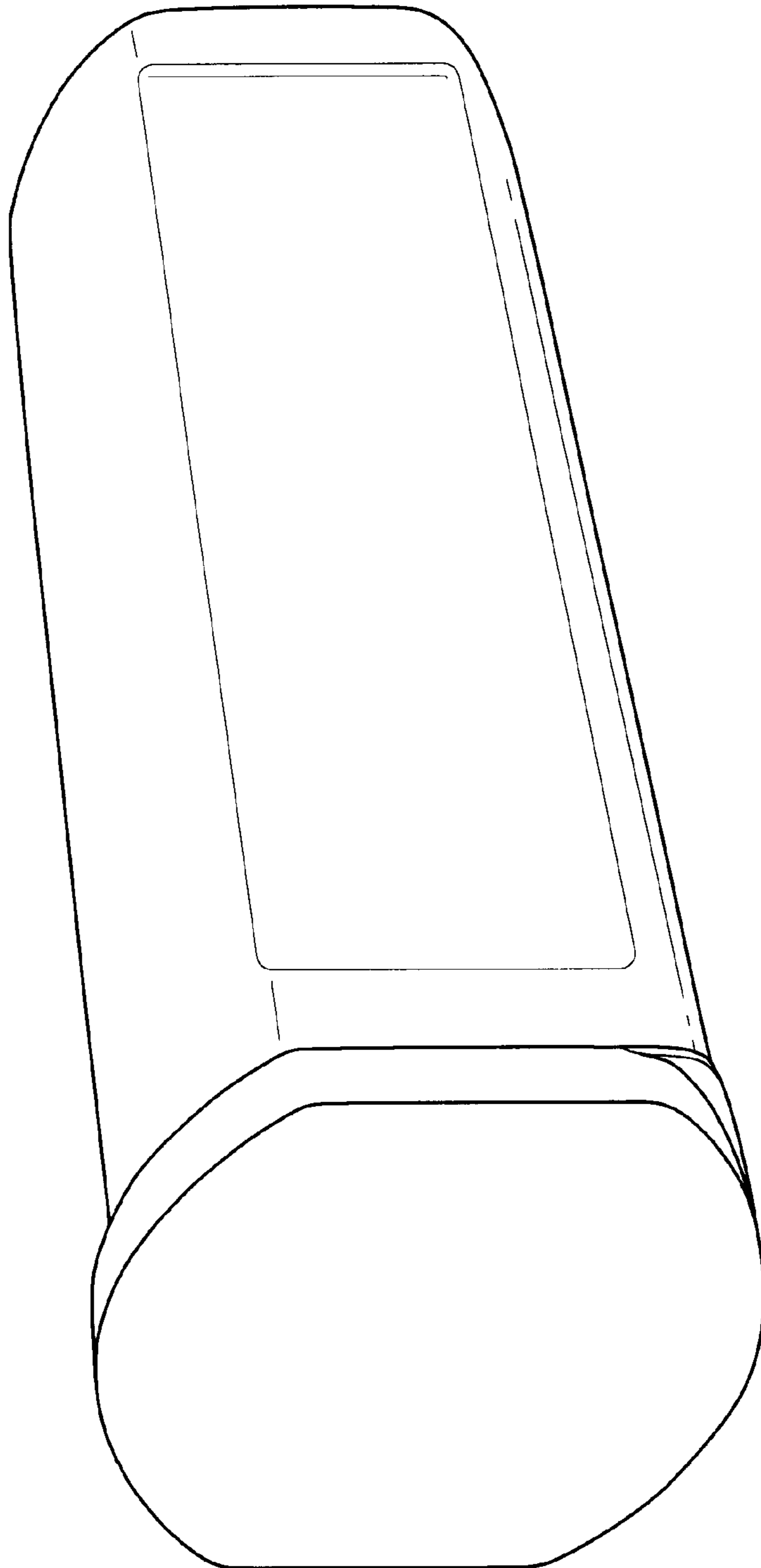

FIG. 4

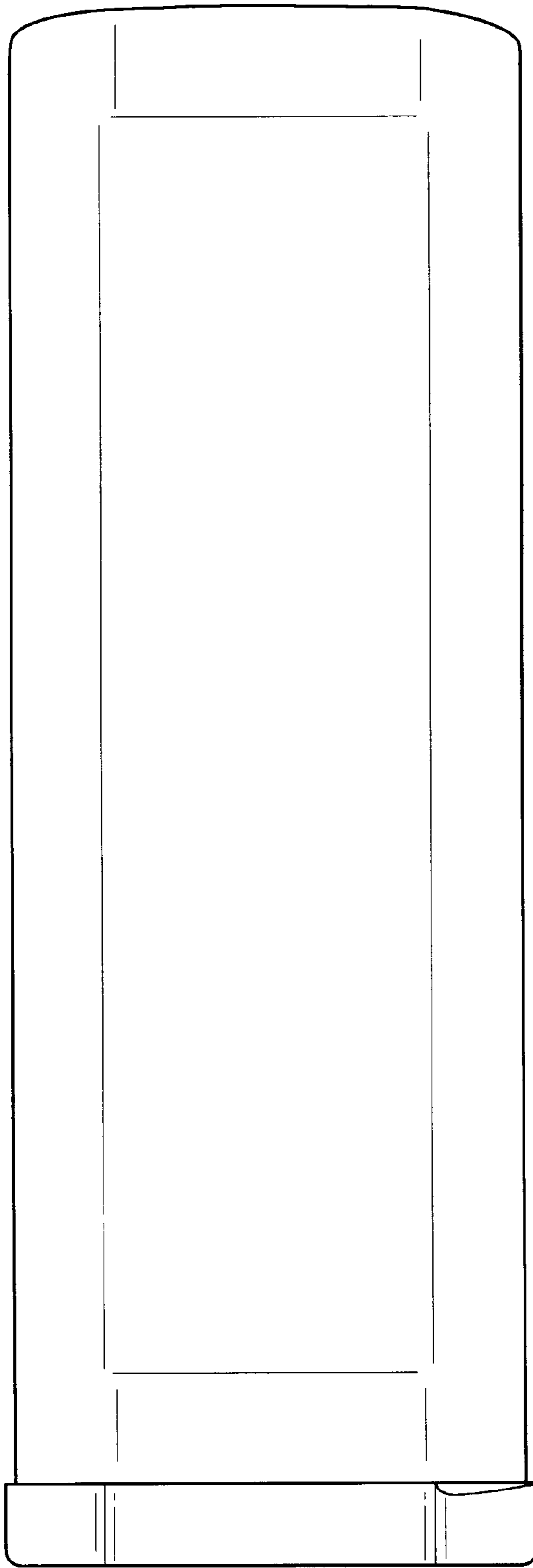

FIG. 5

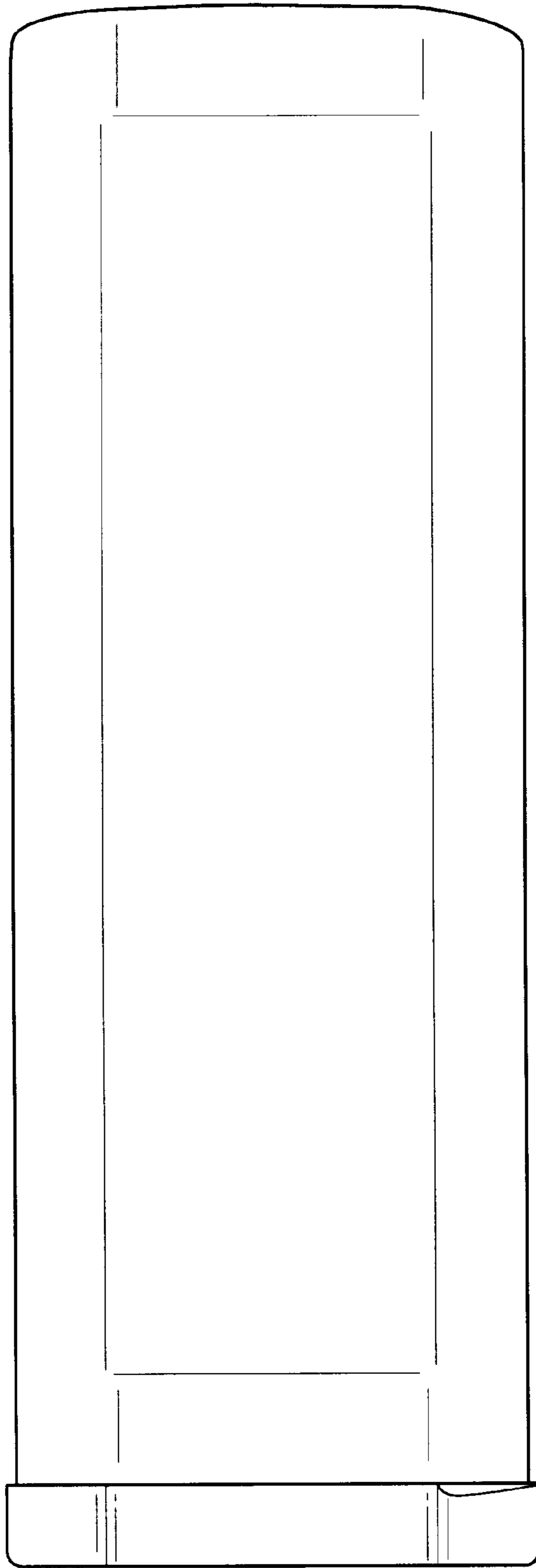
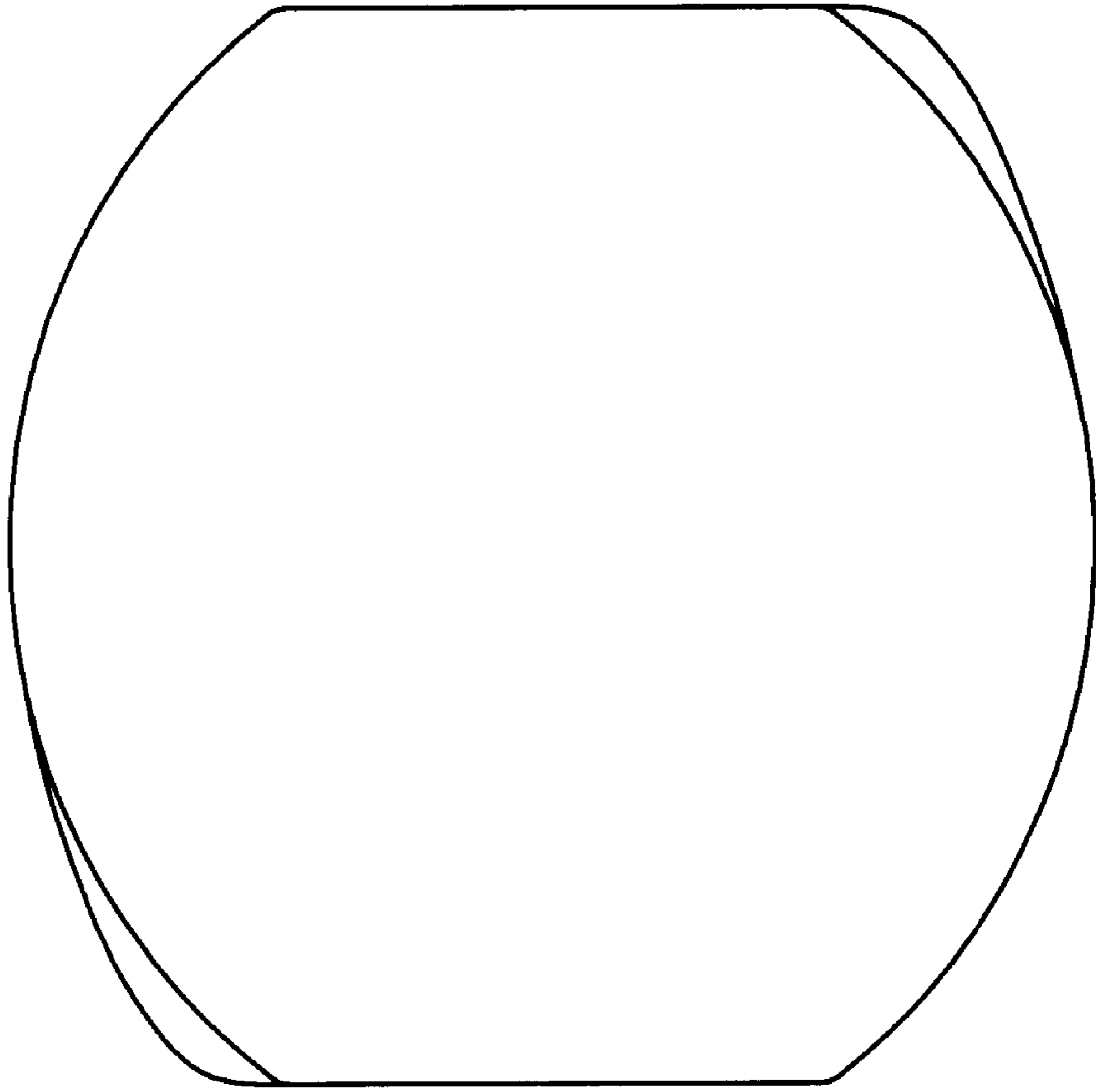
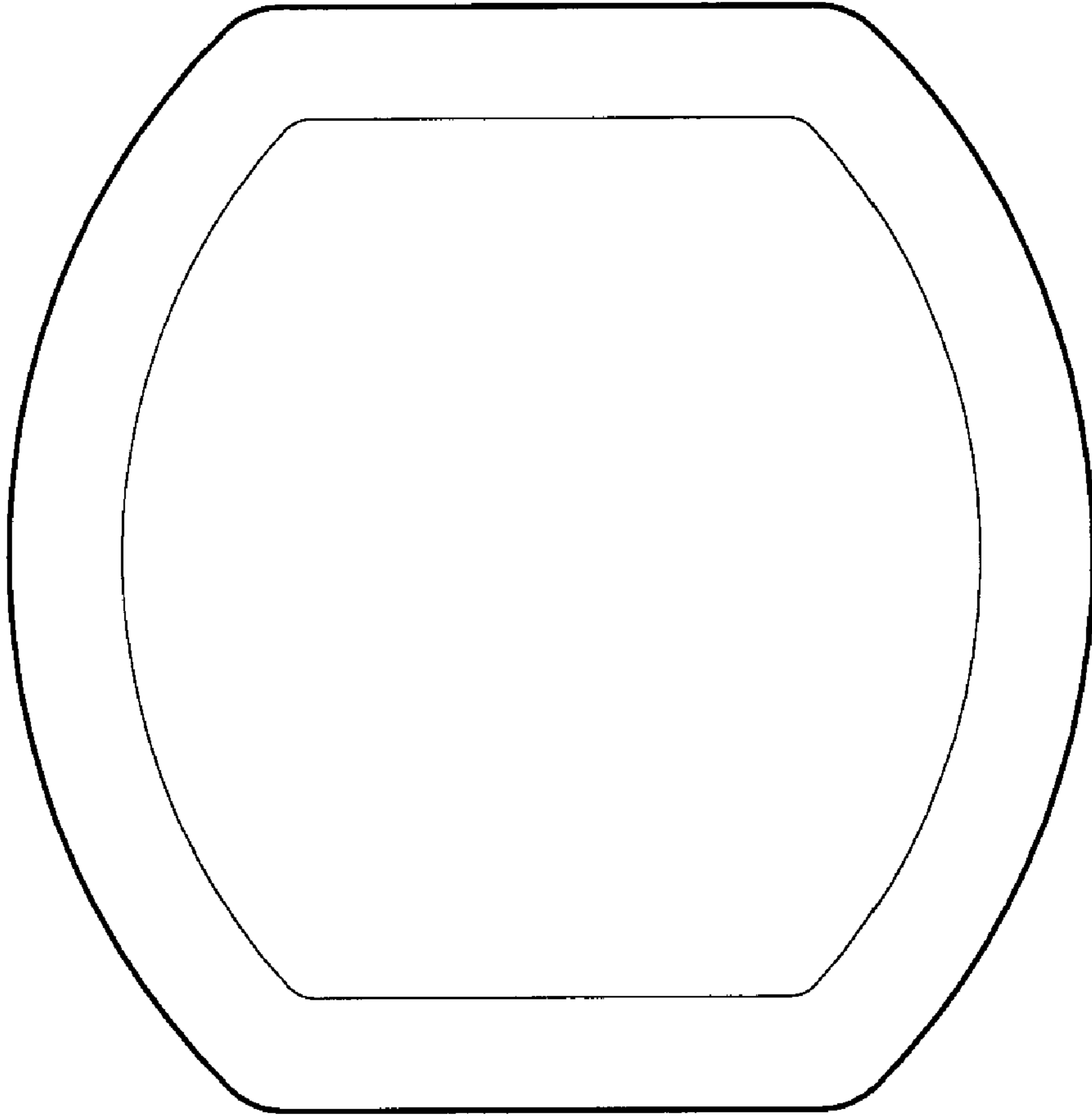

FIG. 6





***FIG. 7***



***FIG. 8***

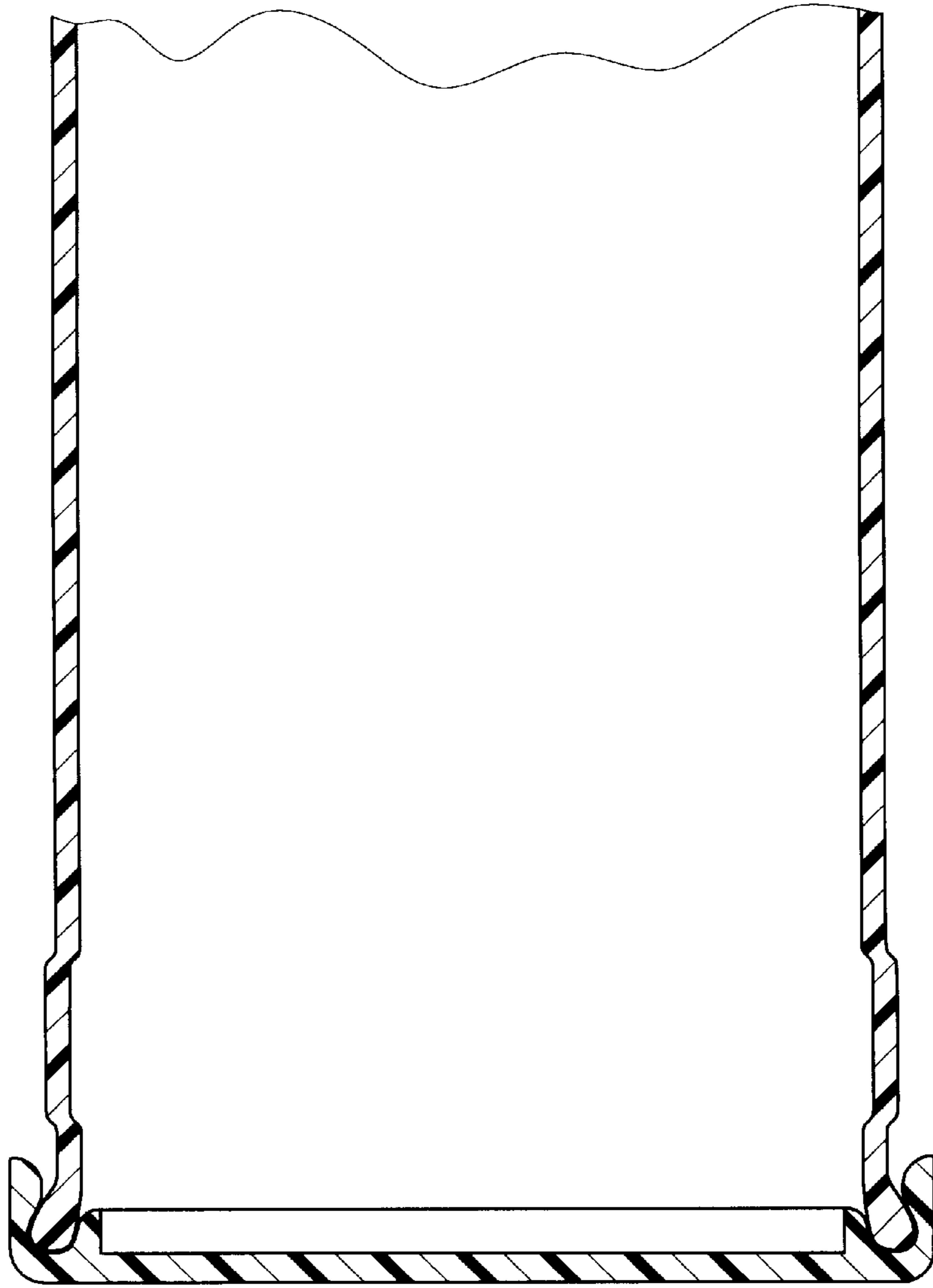
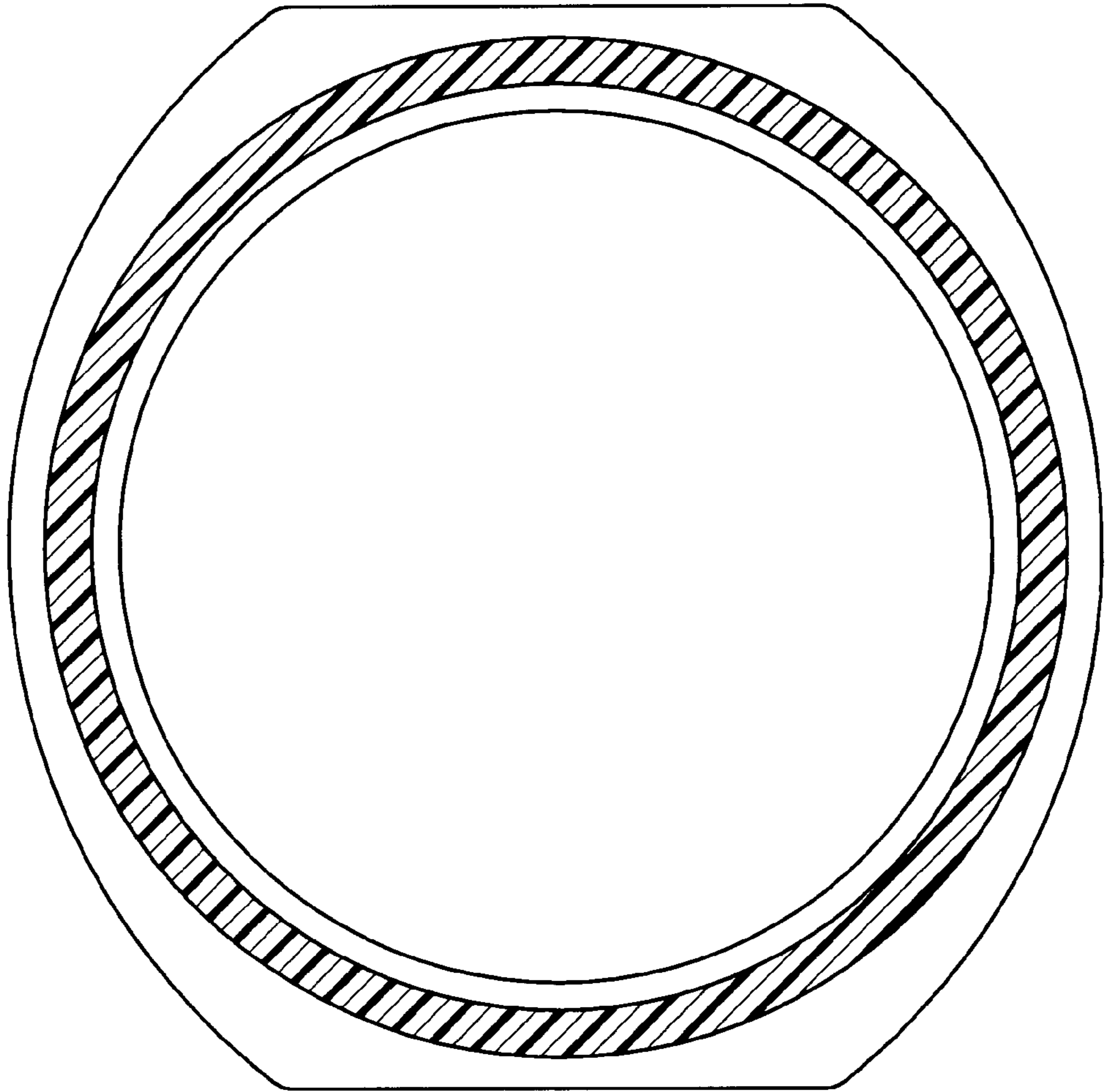

FIG. 9



**FIG. 10**

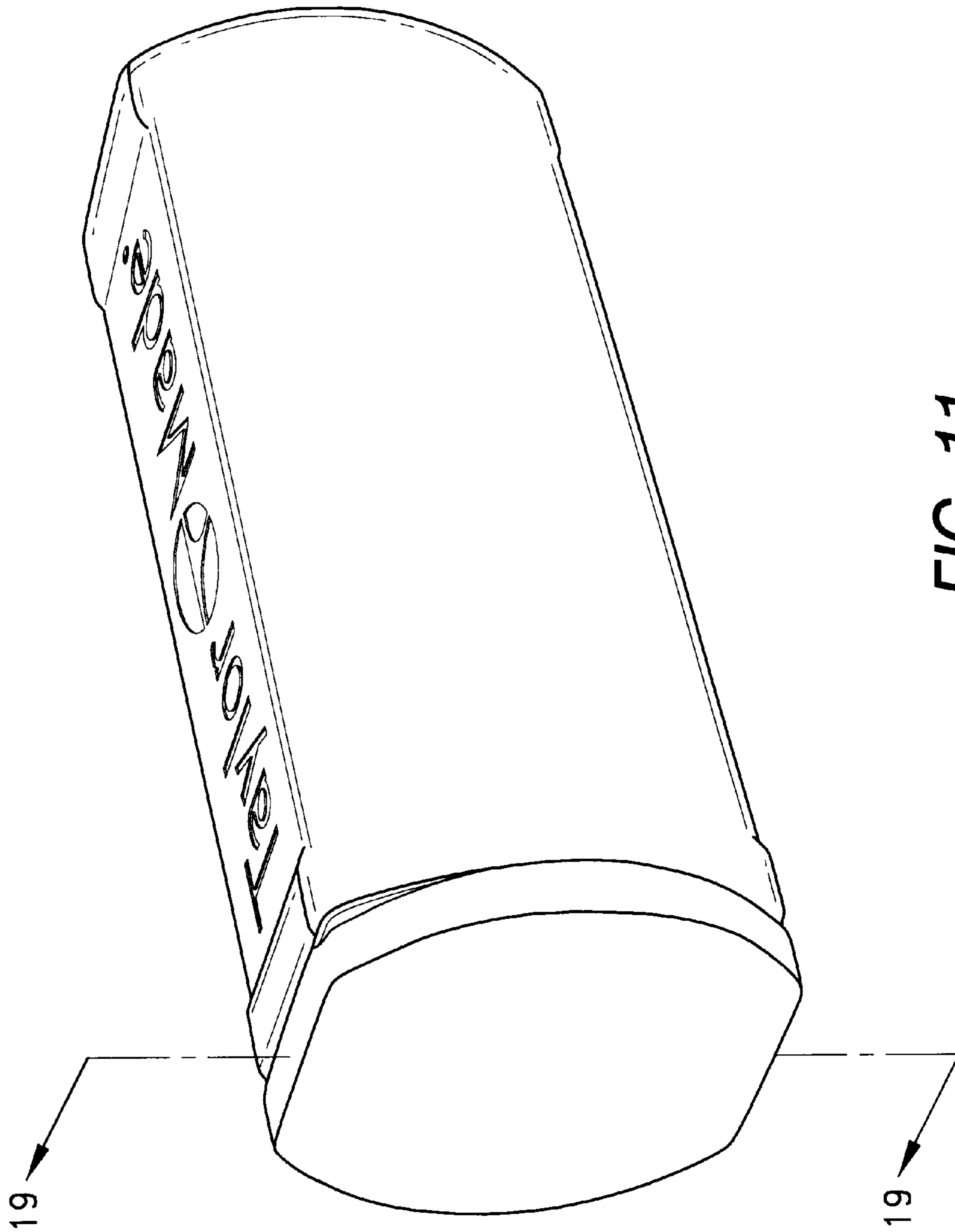

FIG. 11

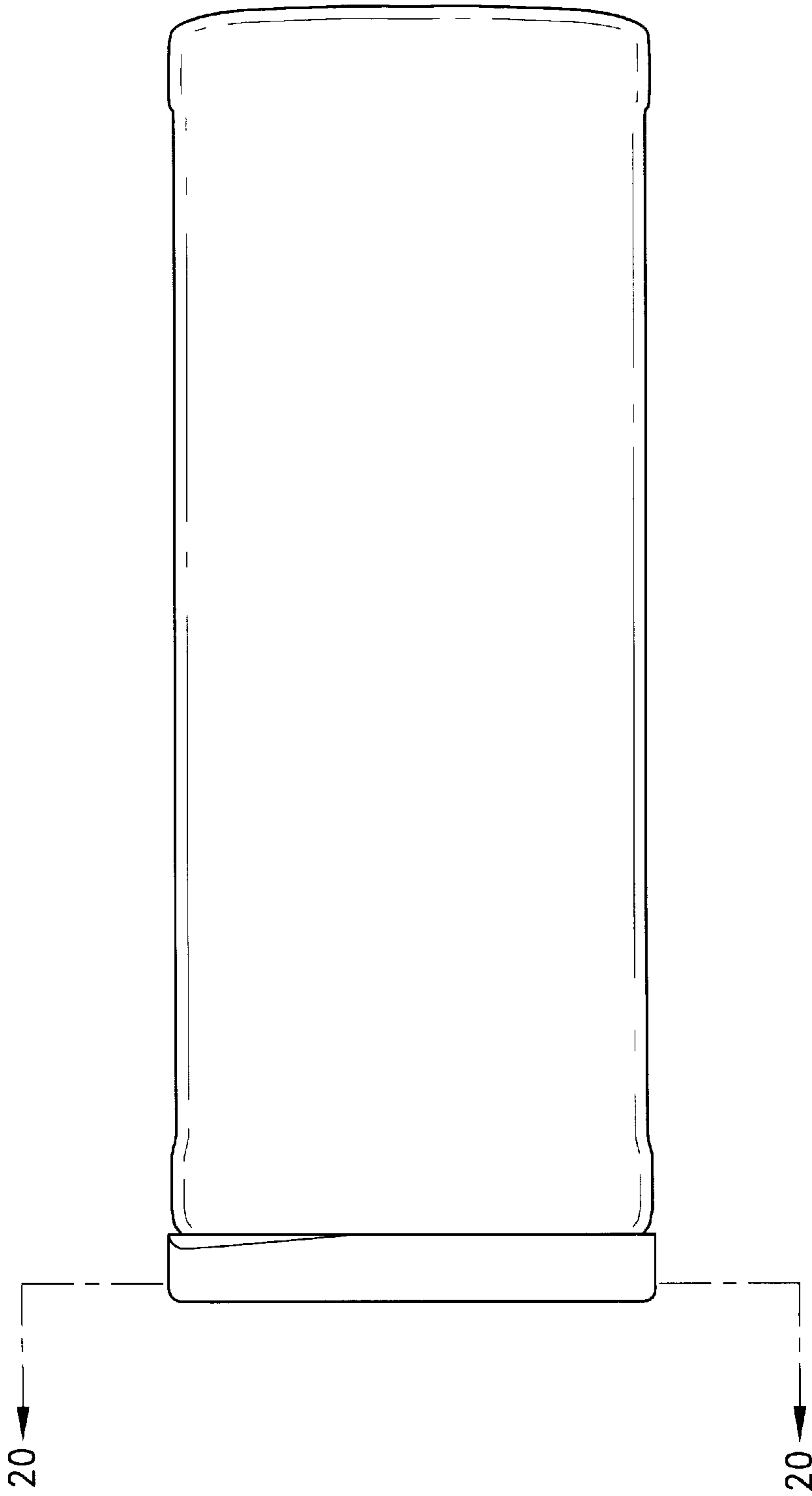

FIG. 12

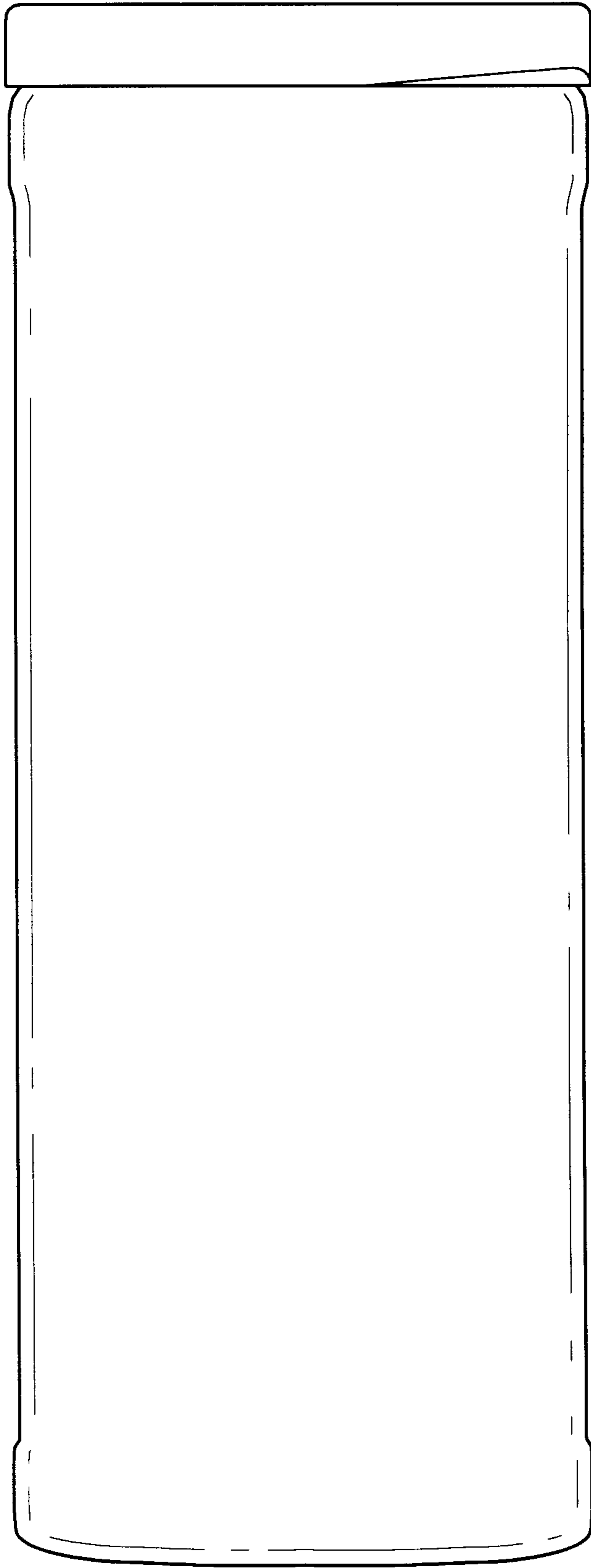

FIG. 13

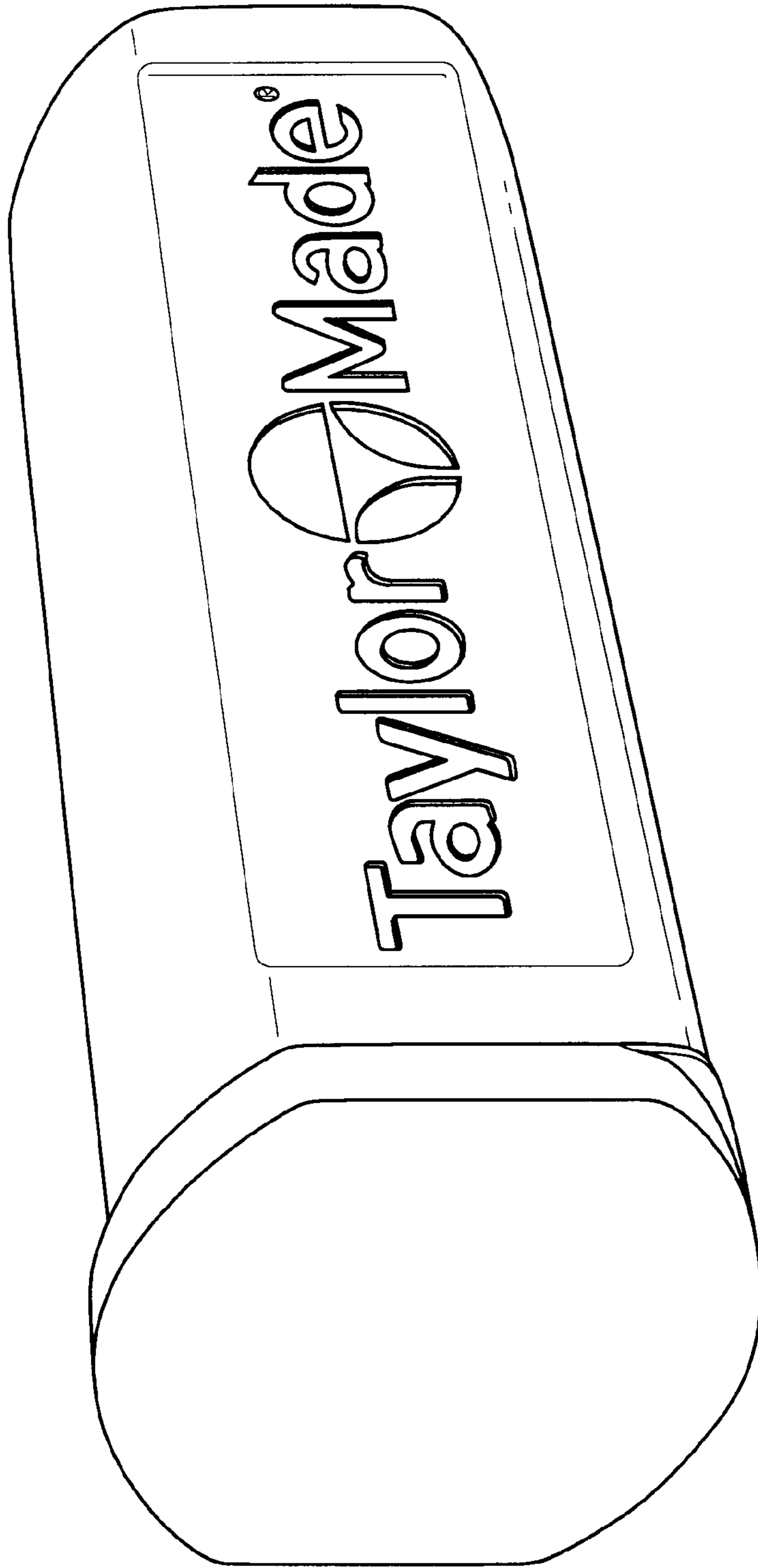

FIG. 14



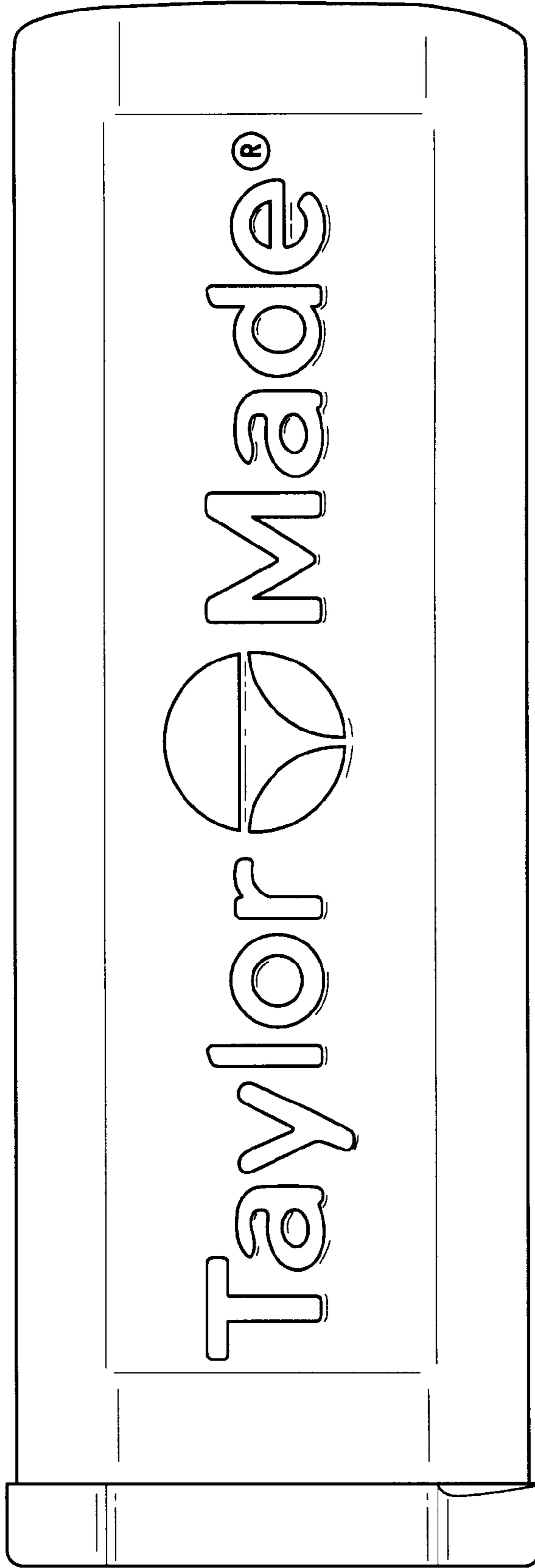

FIG. 15

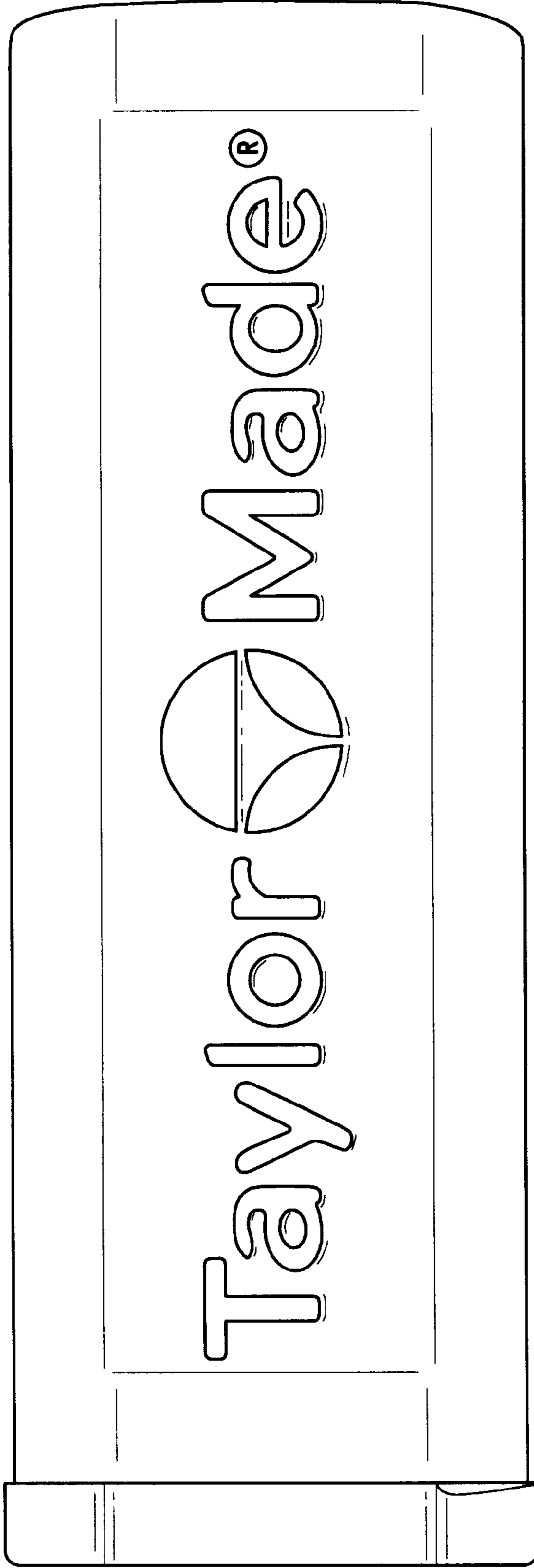
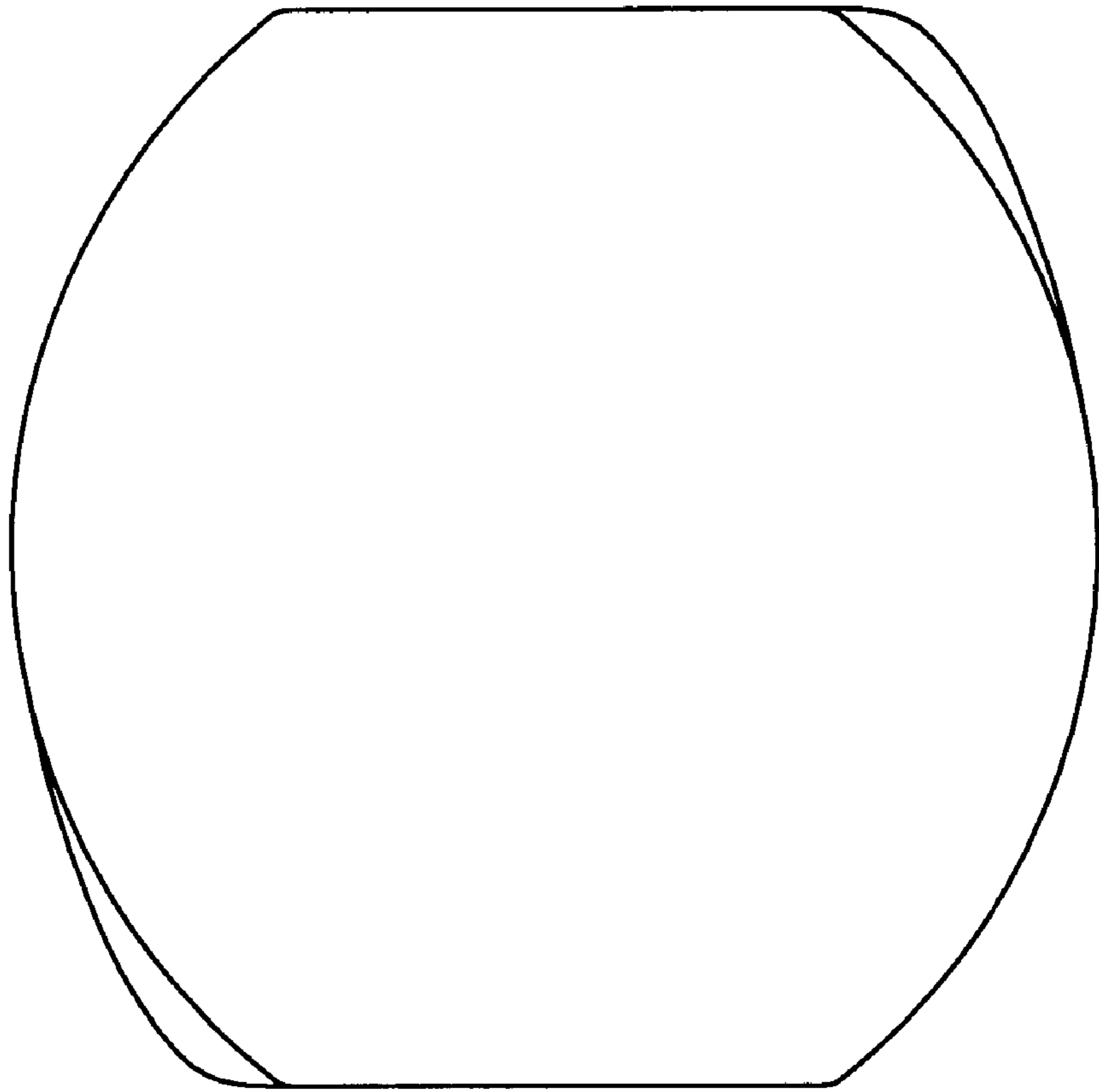
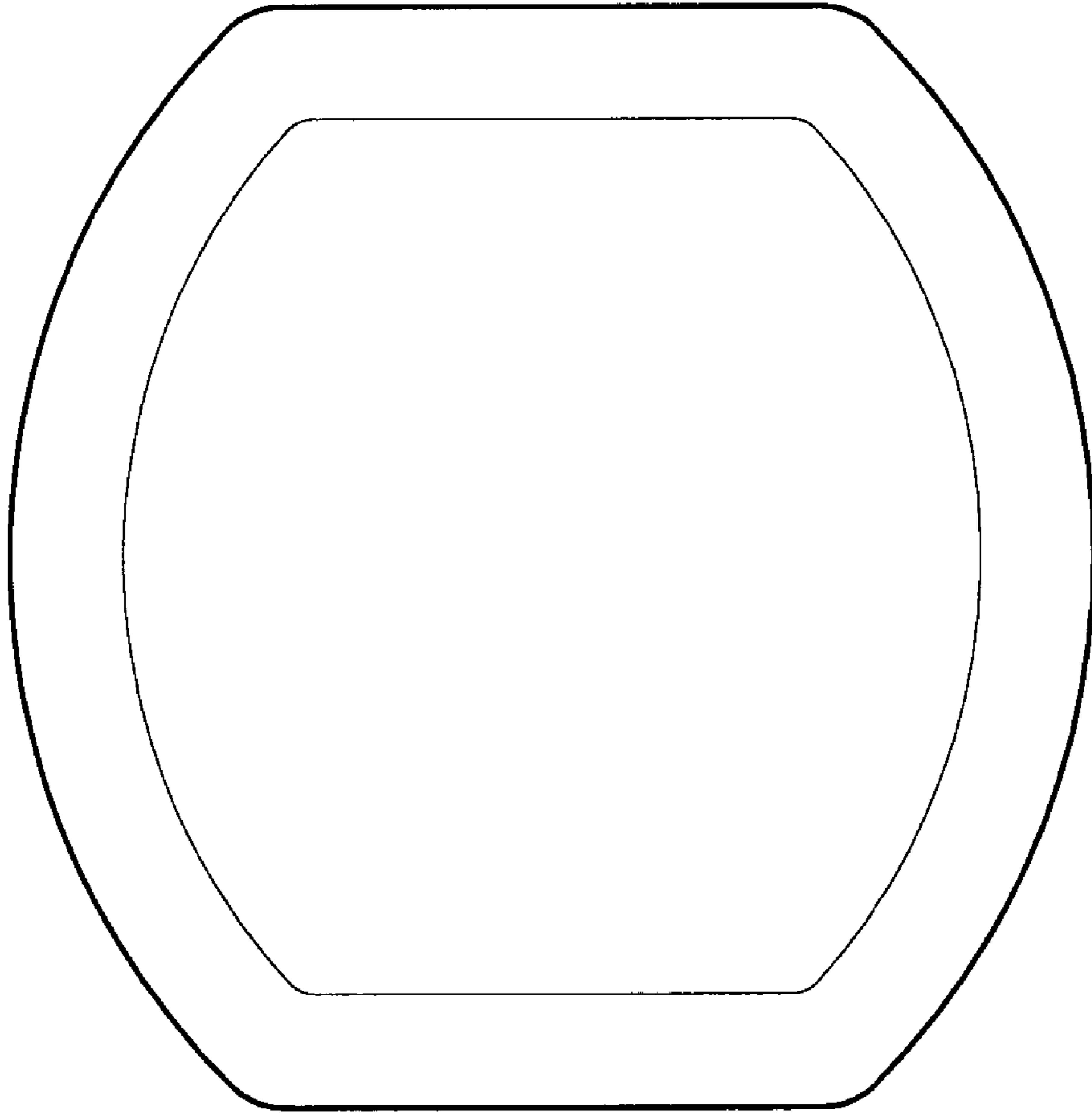

FIG. 16



***FIG. 17***



***FIG. 18***

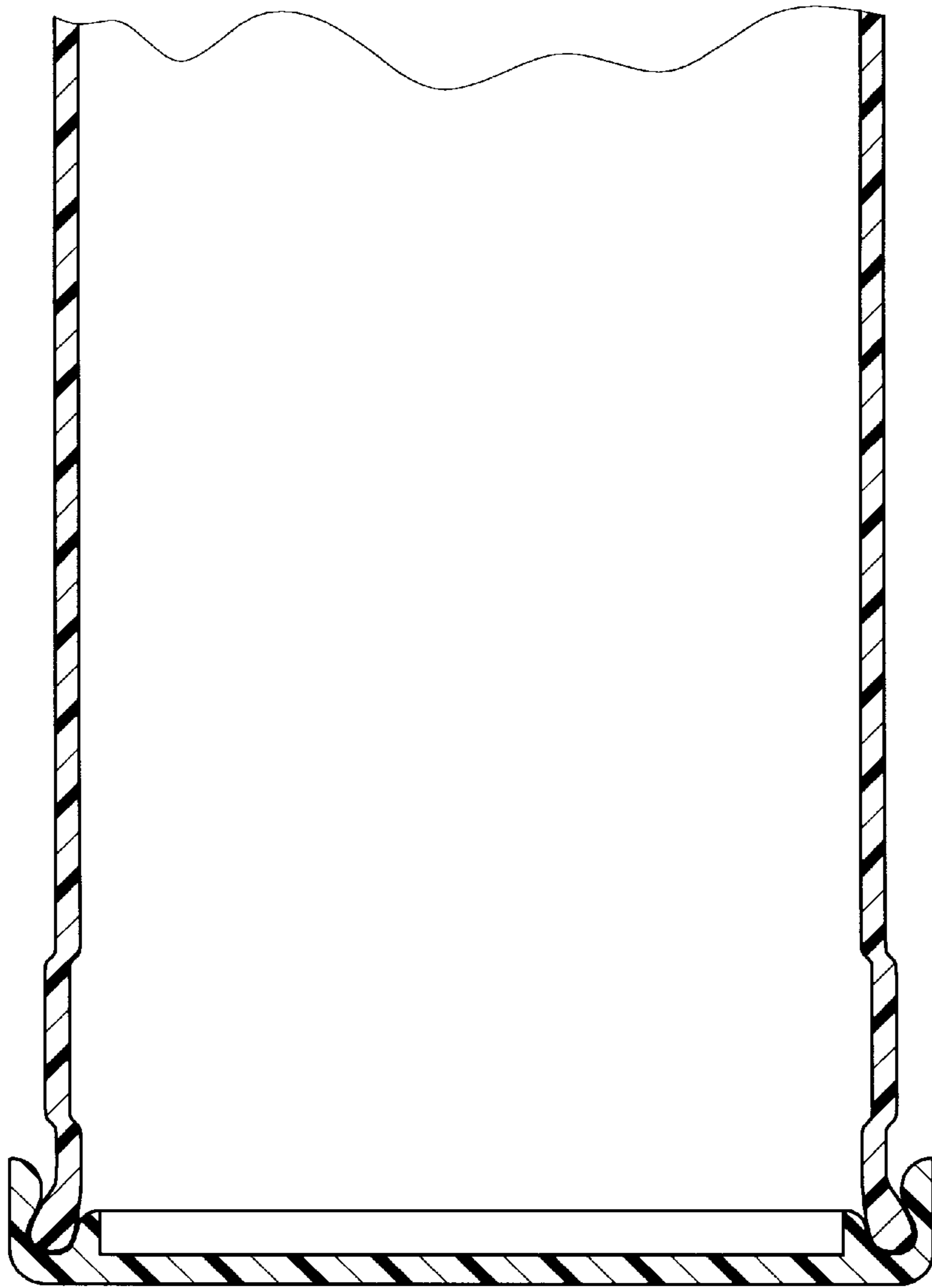
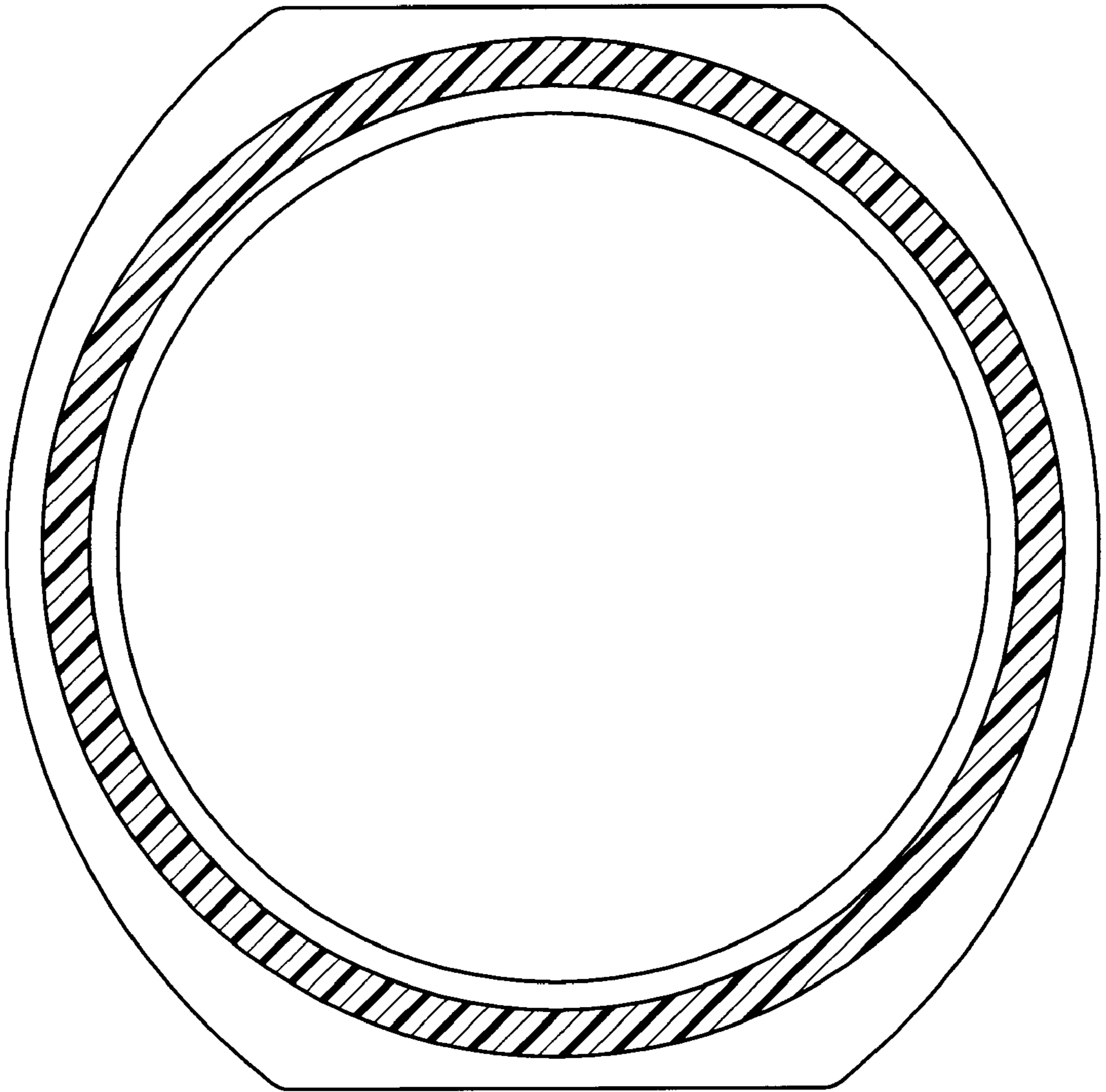

FIG. 19



**FIG. 20**

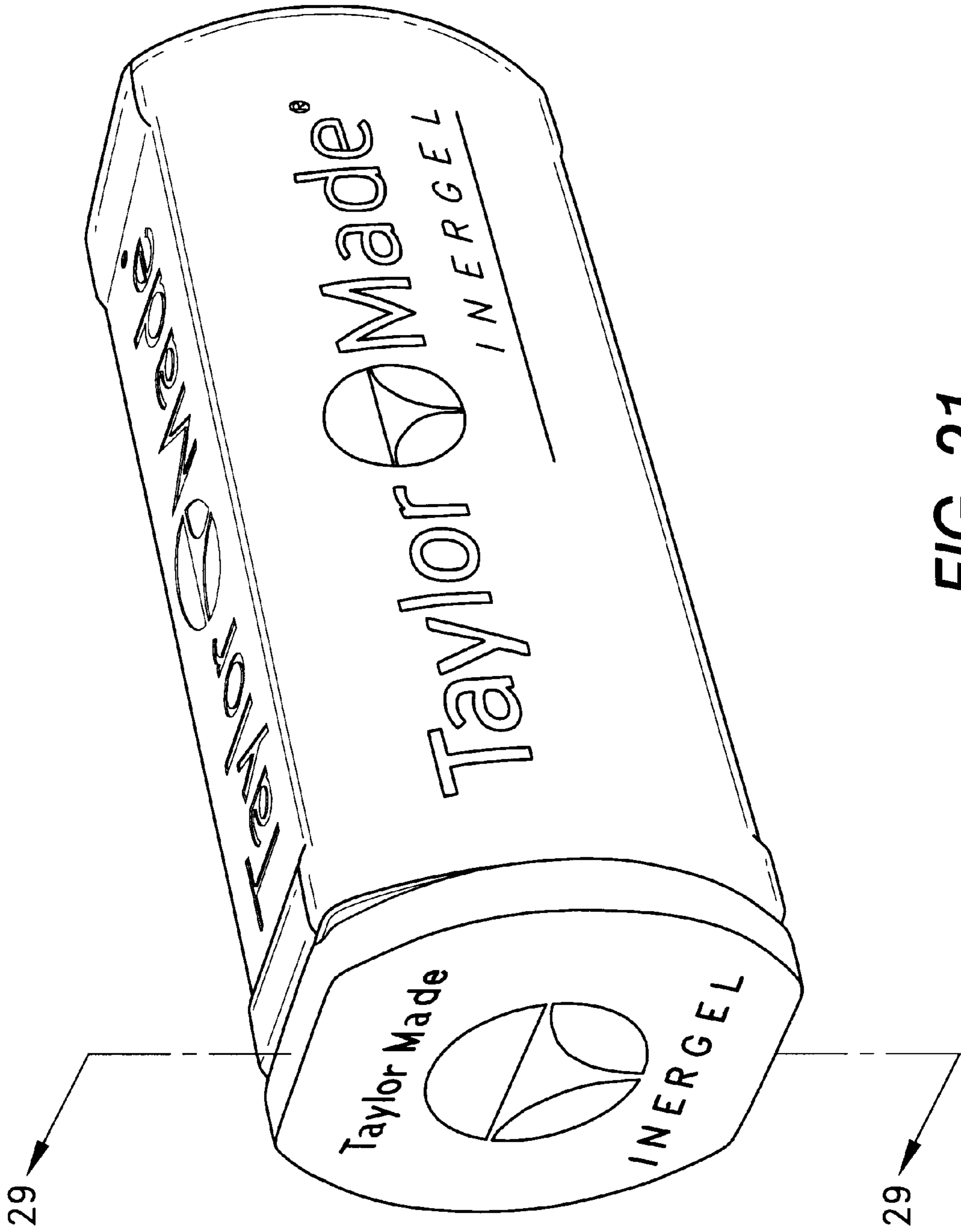

FIG. 21

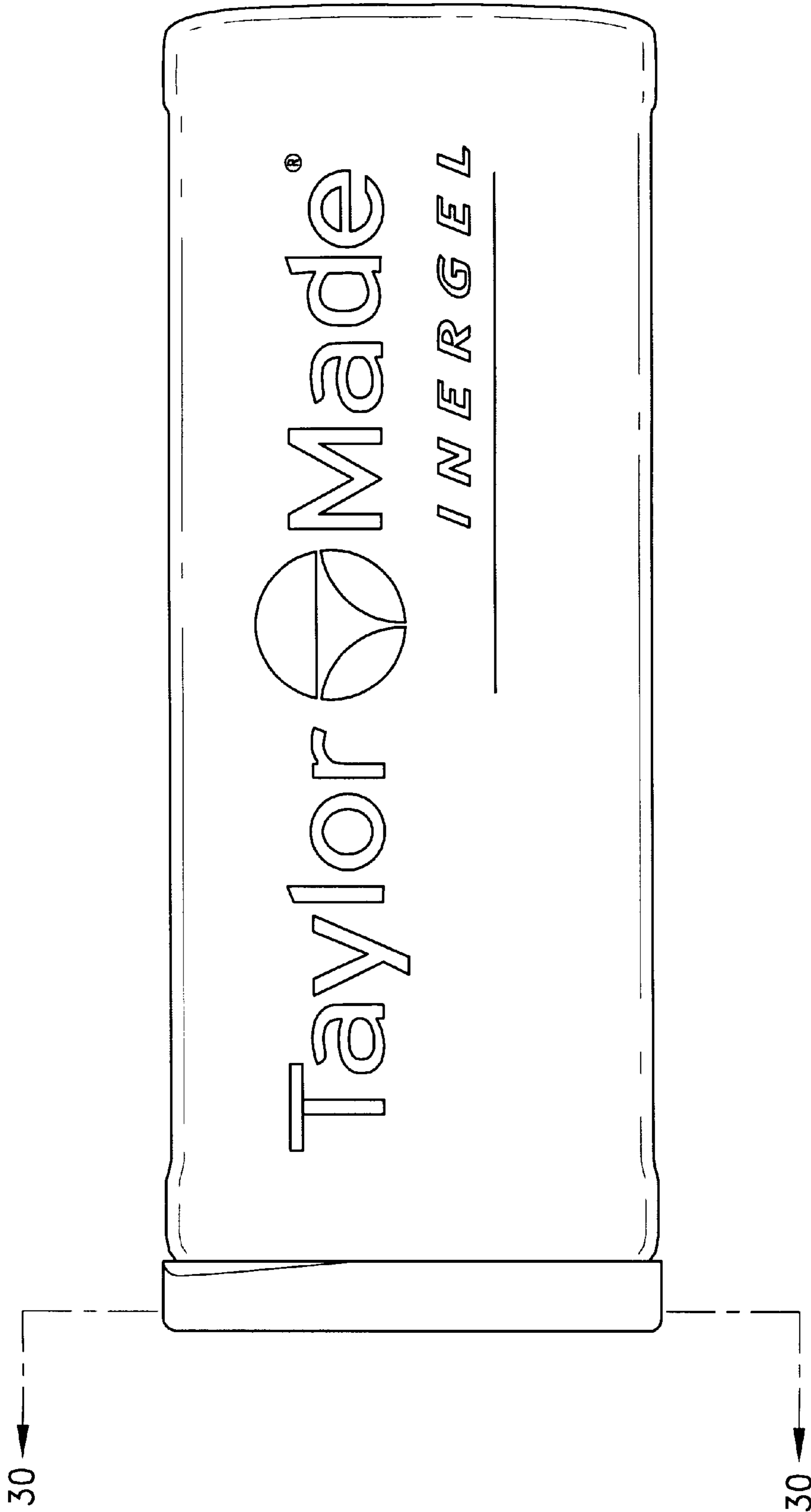

FIG. 22



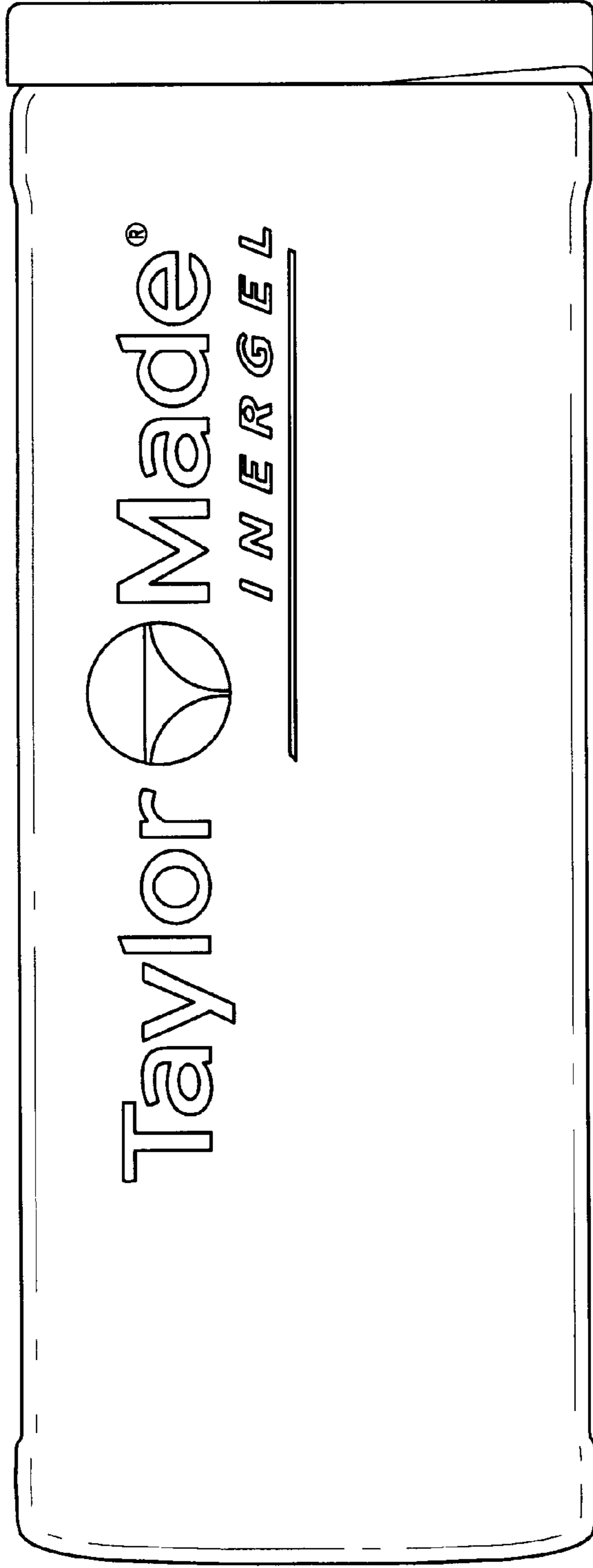

FIG. 23

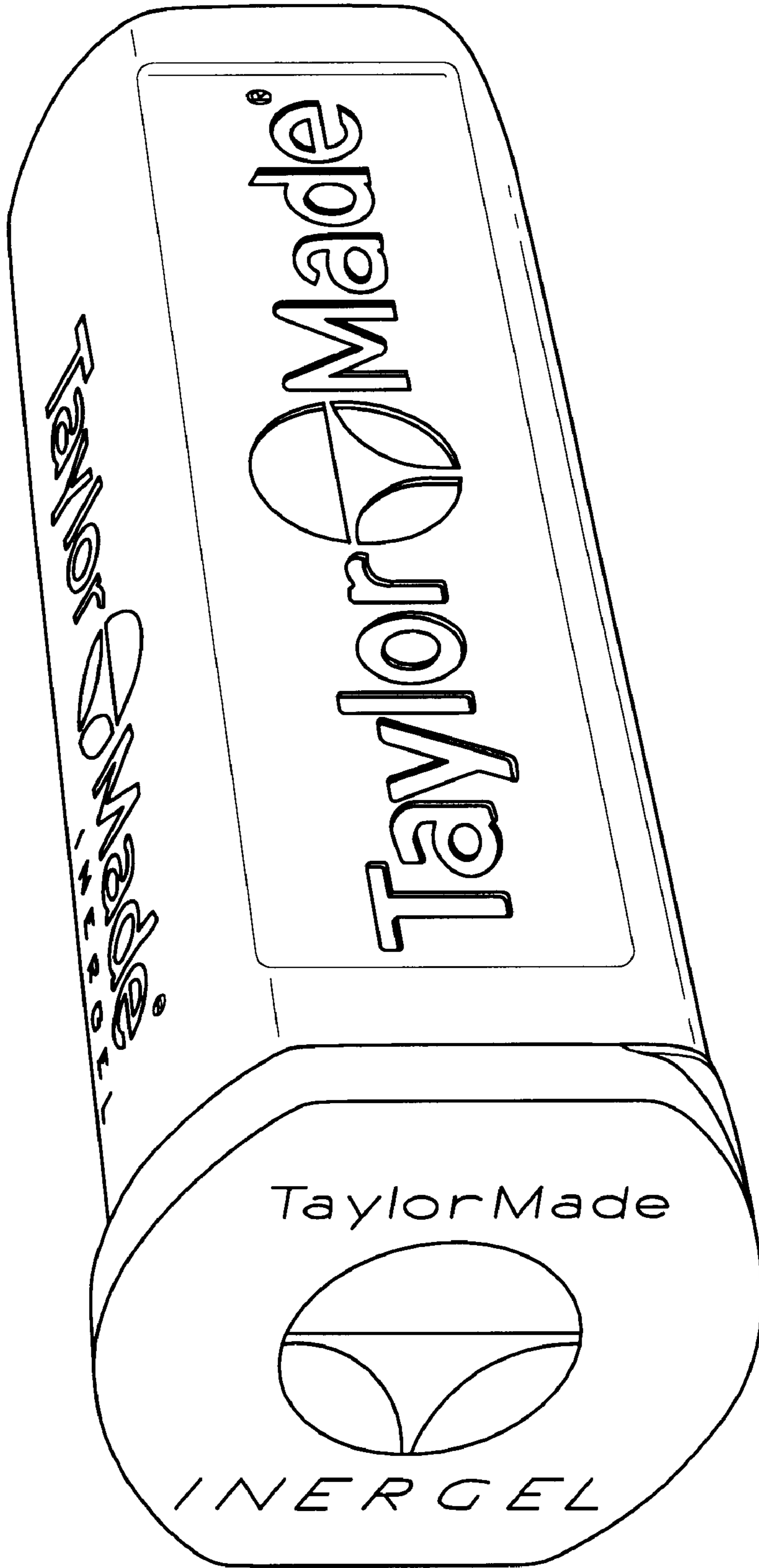

FIG. 24

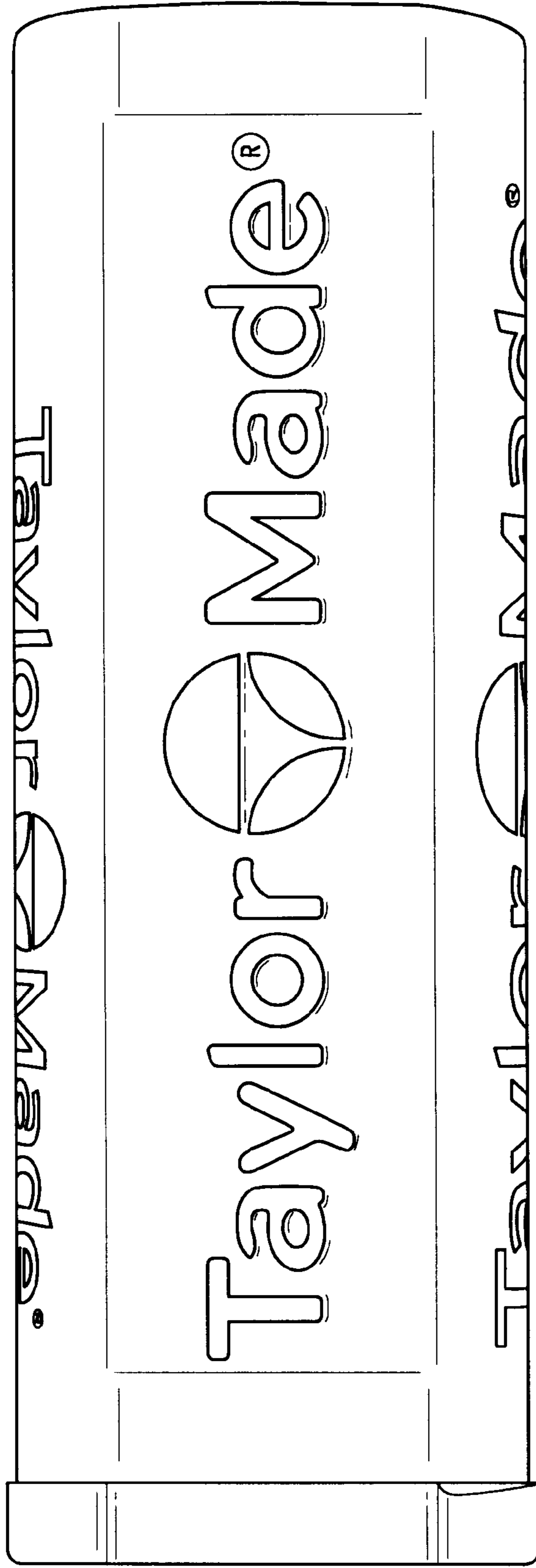

FIG. 25

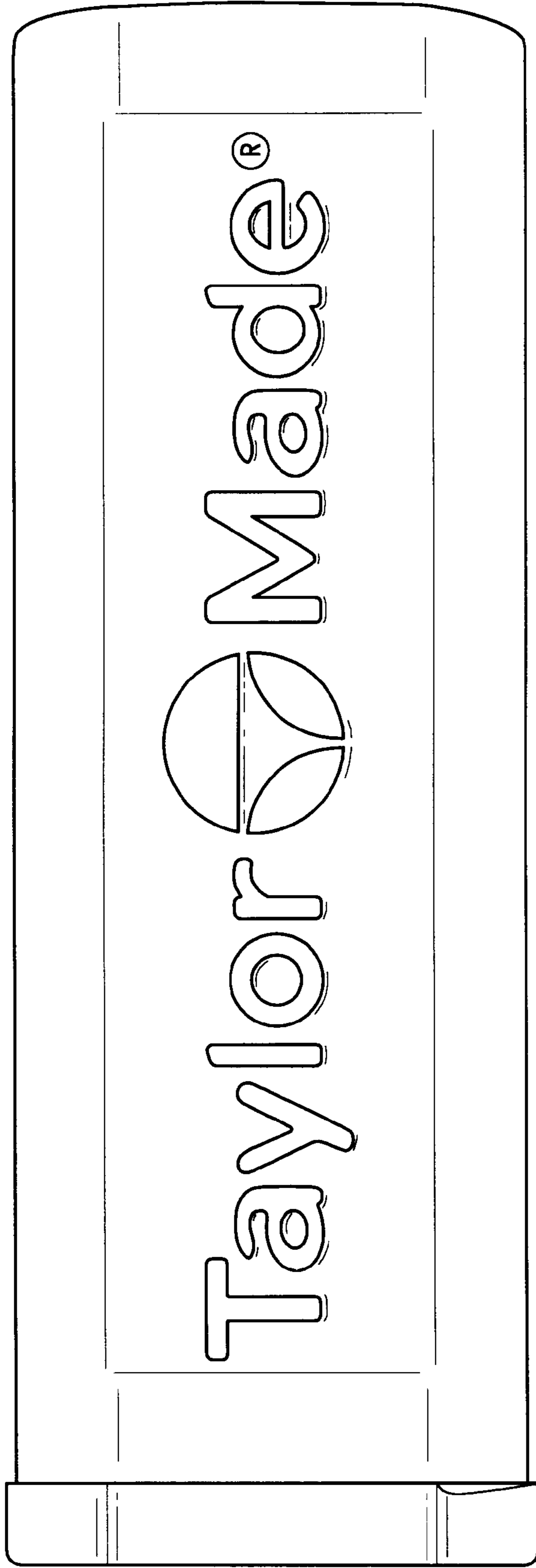
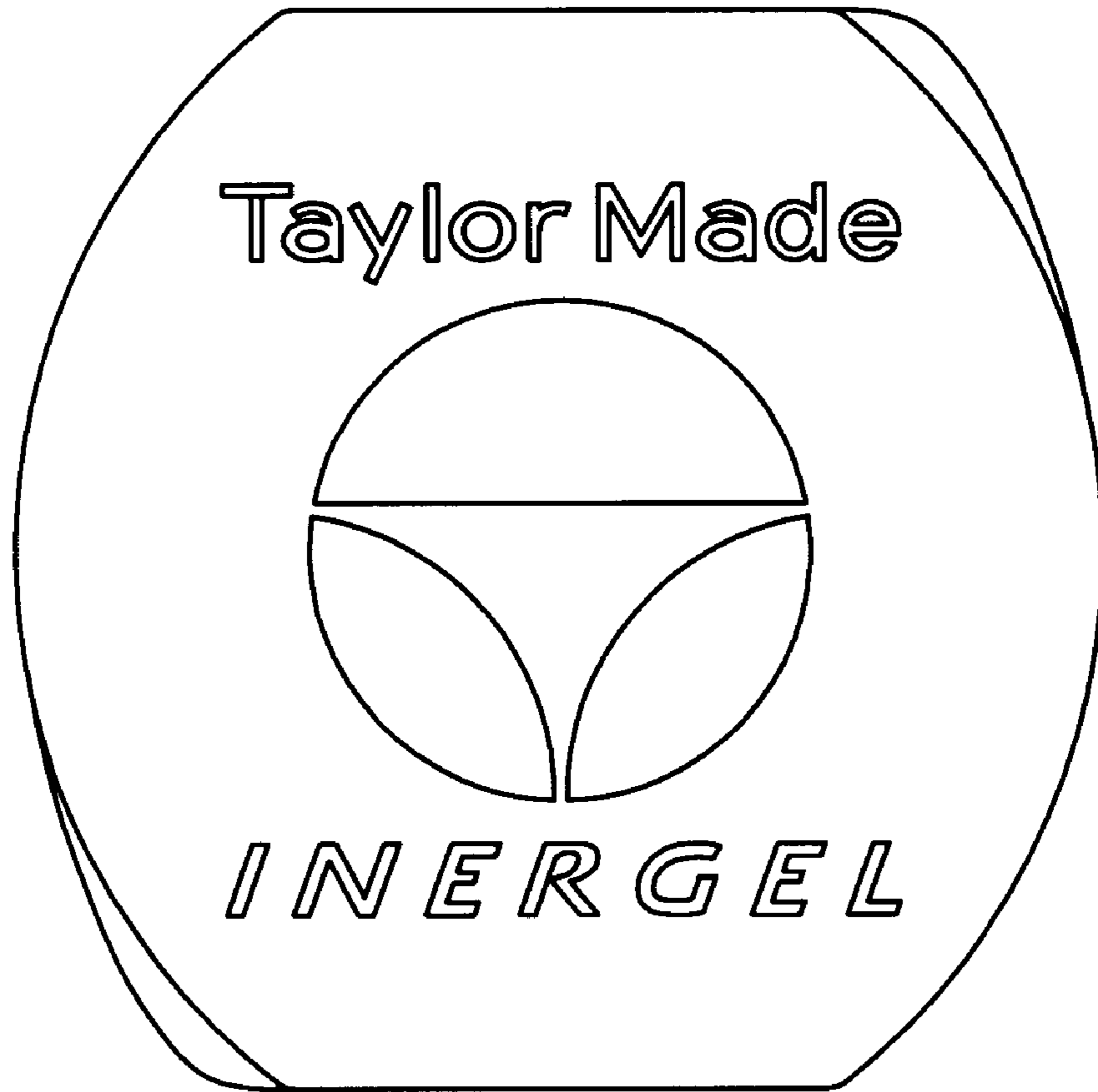
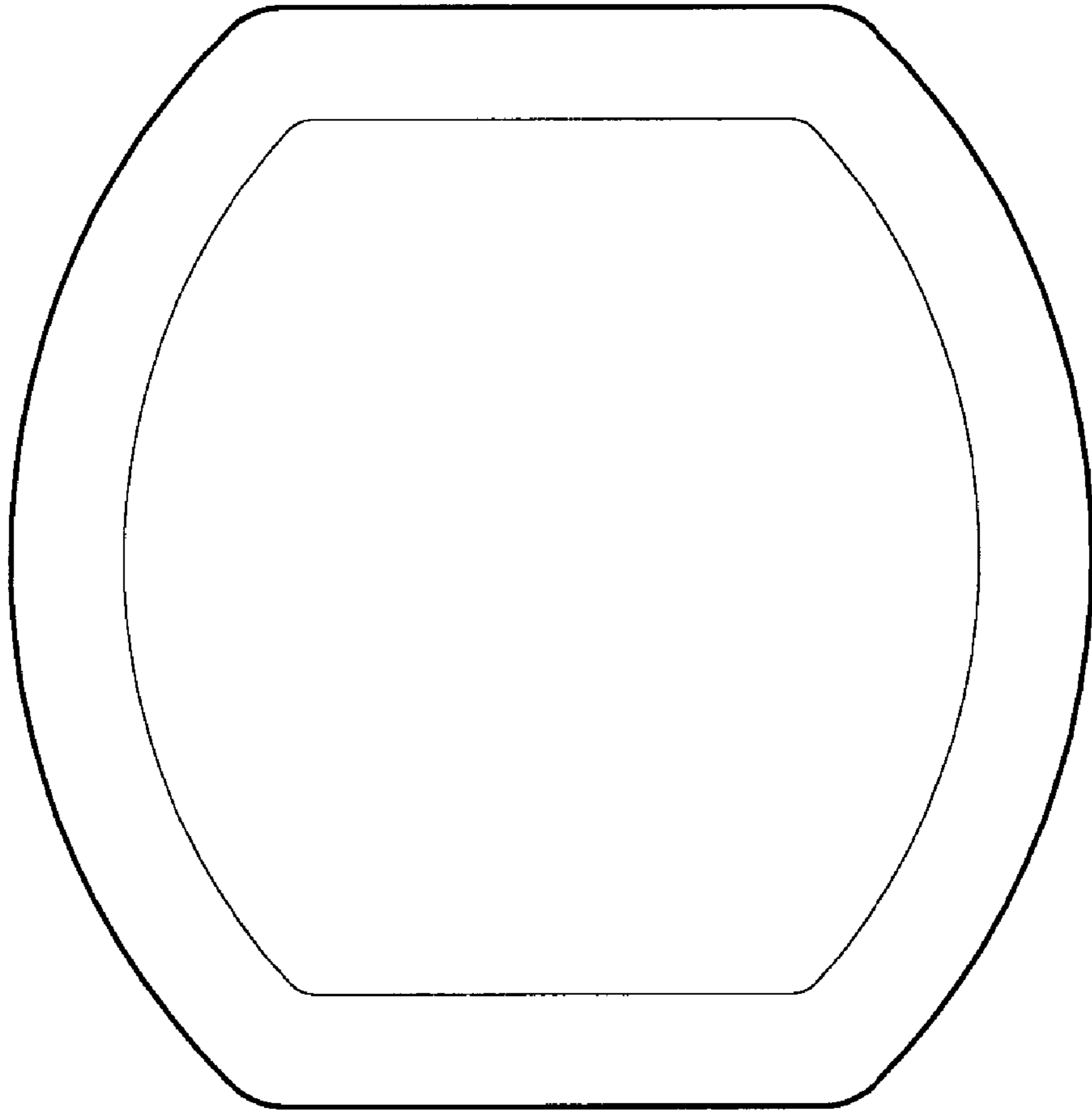

FIG. 26



**FIG. 27**



***FIG. 28***

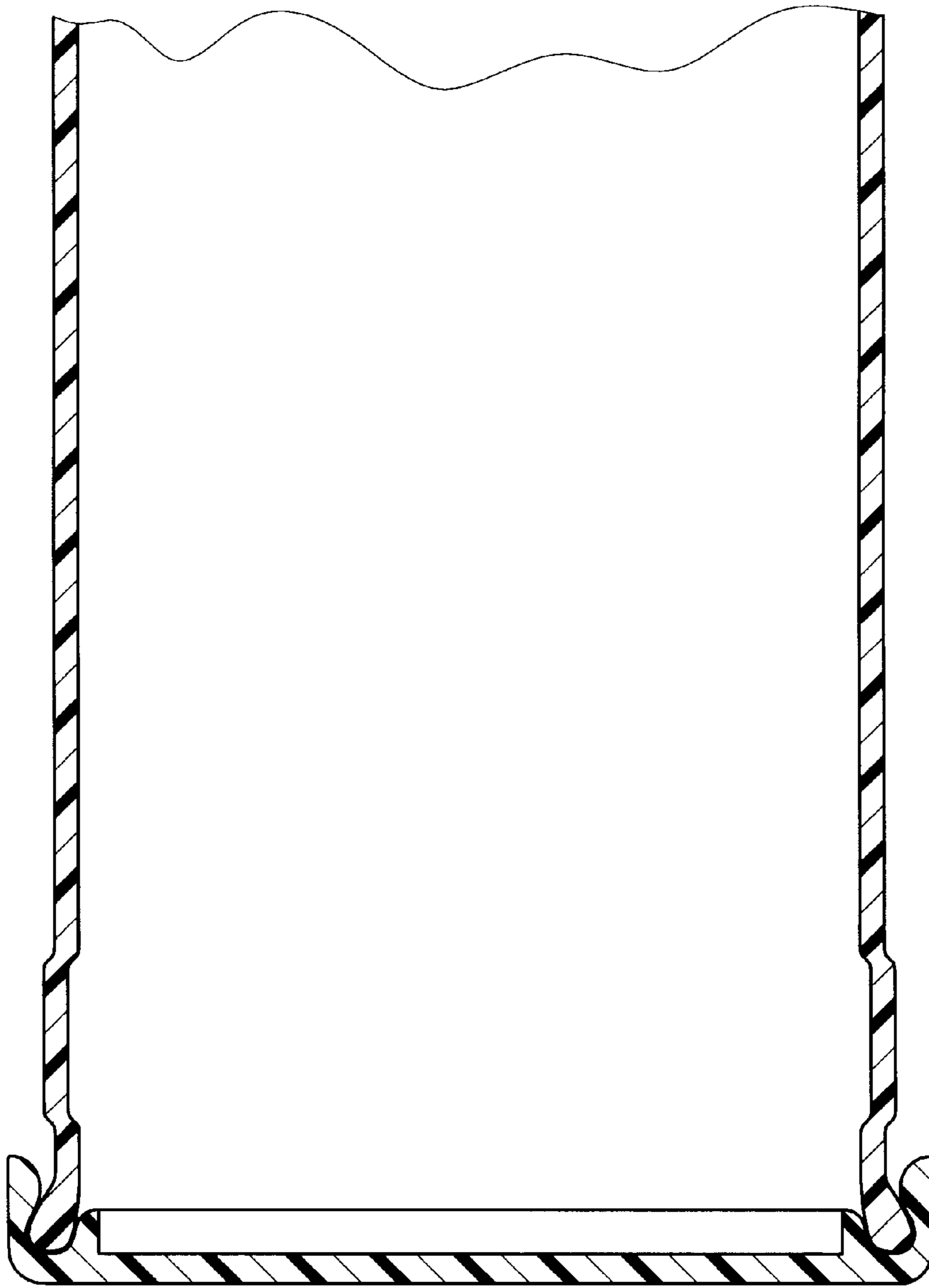
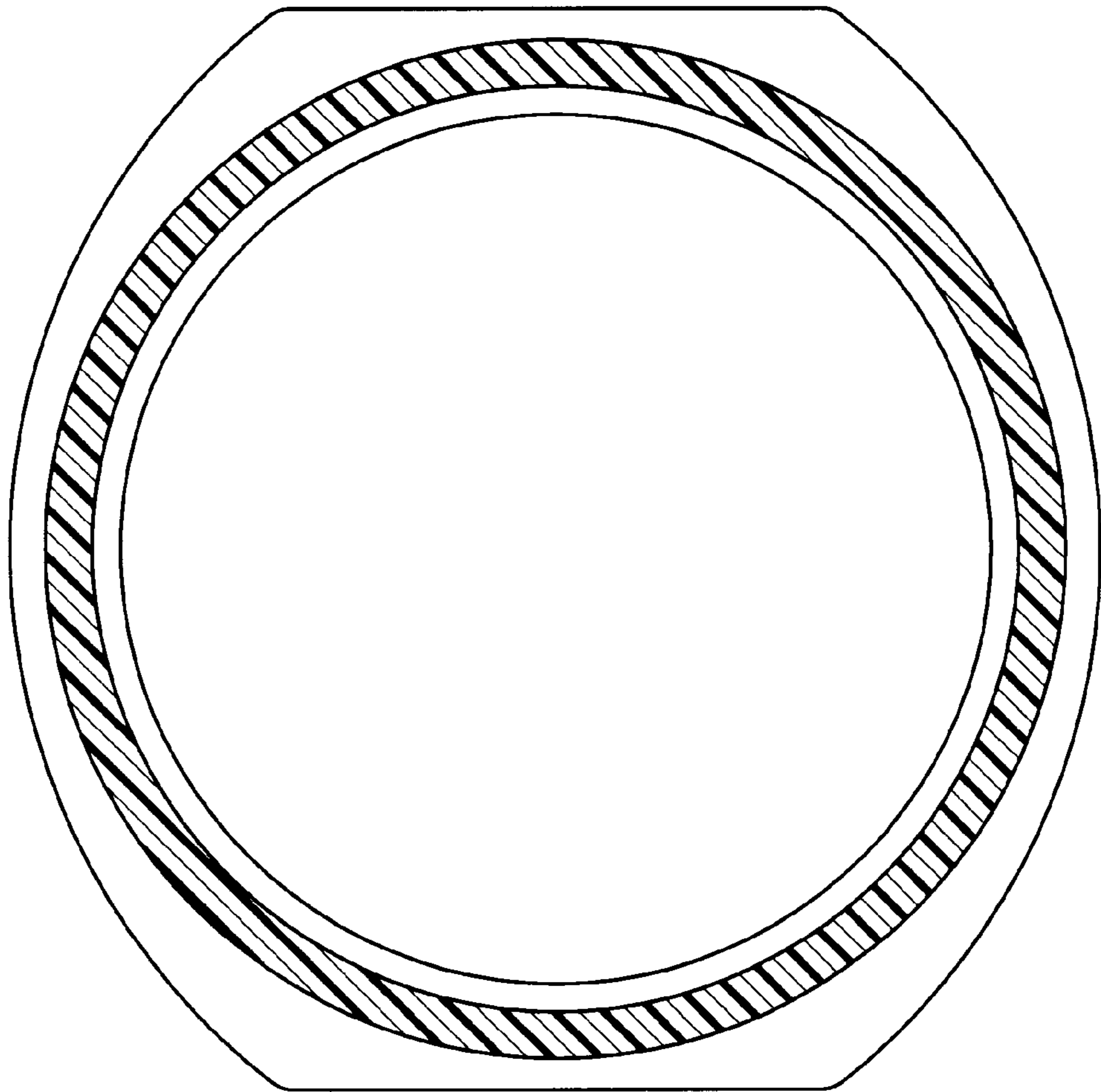

FIG. 29



**FIG. 30**