



US00D417047S

United States Patent [19]
Tsuda

[11] **Patent Number: Des. 417,047**

[45] **Date of Patent: ** Nov. 23, 1999**

[54] **ELECTRIC VACUUM CLEANER**

[75] Inventor: **Yukihiro Tsuda**, Nara, Japan

[73] Assignee: **Matsushita Electric Industrial Co., Ltd.**, Japan

[**] Term: **14 Years**

[21] Appl. No.: **29/087,981**

[22] Filed: **May 13, 1998**

[30] **Foreign Application Priority Data**

Nov. 27, 1997 [JP] Japan 9-76771

[51] **LOC (6) Cl.** **15-05**

[52] **U.S. Cl.** **D32/21**

[58] **Field of Search** D32/21, 23, 24;
15/320-321, 327.1, 327.2, 327.6, 327.7,
347

[56] **References Cited**

U.S. PATENT DOCUMENTS

D. 325,273	4/1992	Ikeda et al.	D32/21
D. 344,375	2/1994	Piret et al.	D32/21
D. 391,700	3/1998	Hughes	D32/21
D. 394,527	5/1998	Pochopien et al.	D32/21
D. 399,617	10/1998	Fujita	D32/21

OTHER PUBLICATIONS

Sanyo Catalog issued in Aug. 10, 1997, containing Sanyo Model Nos. SC-MX05, SC-AO5, SC-ASO5, SC-M9, SC-A9, SC-9, SC-WX55, SC-88, SC-T7, SC-L2, SC-ATP2, SC-H20, and SC-P95V.

National Catalog issued on Nov. 1, 1997, containing Matsushita Model Nos. S101XP, S66, S100XP, L52VA, S60VA, M60, M50, L51 and L31P A11C.

Primary Examiner—Ruth McInroy

Attorney, Agent, or Firm—SAIDMAN DesignLaw Group

[57] **CLAIM**

The ornamental design for an electric vacuum cleaner, as shown and described.

DESCRIPTION

FIG. 1 is a perspective view of the top, front and right side of an electric vacuum cleaner showing my new design; FIG. 2 is a front view thereof; FIG. 3 is a top plan view thereof; FIG. 4 is a right side view thereof; FIG. 5 is a left side view thereof; FIG. 6 is a bottom view thereof; FIG. 7 is a rear view thereof; and, FIG. 8 is a reference view showing the handle in a raising position.

1 Claim, 4 Drawing Sheets

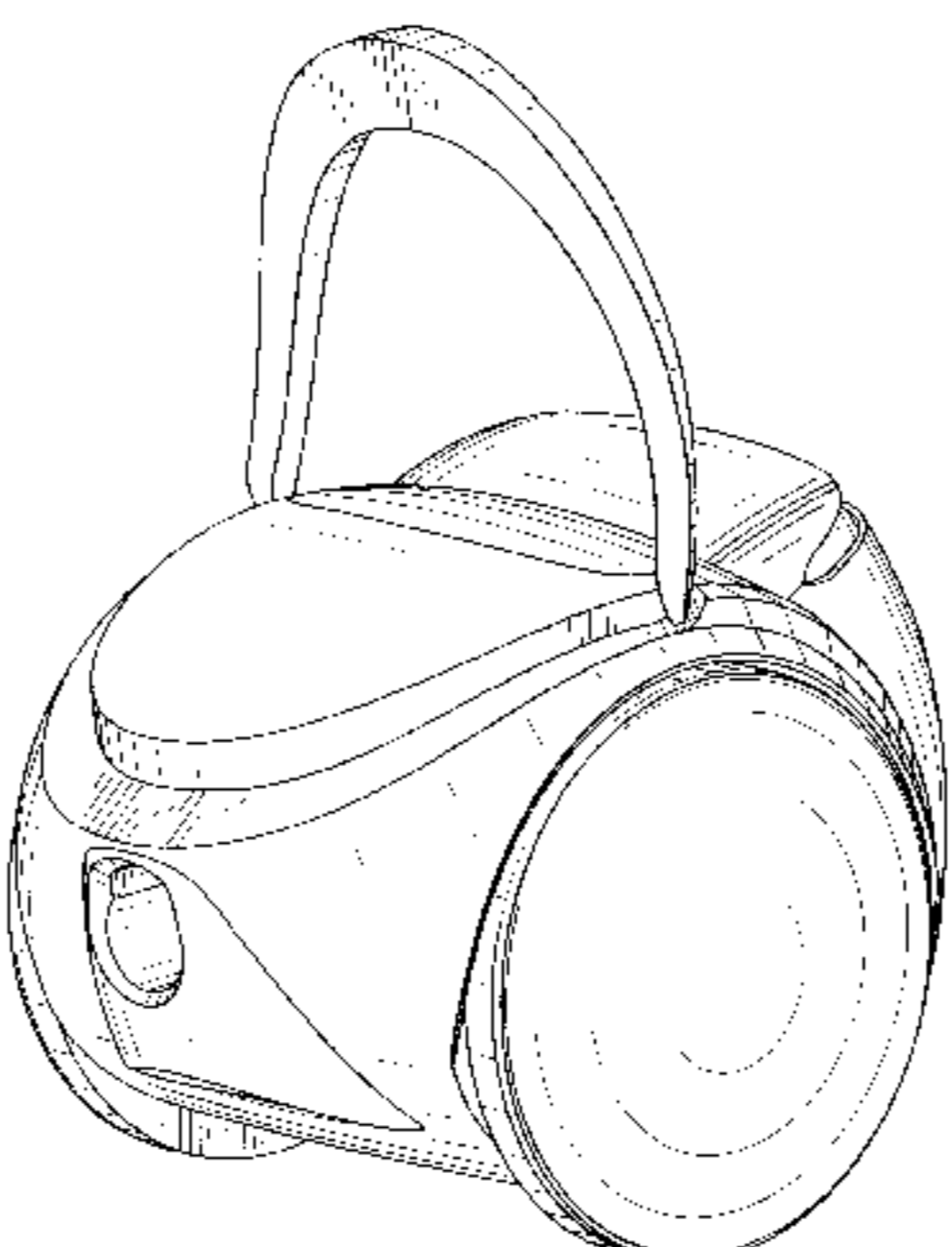
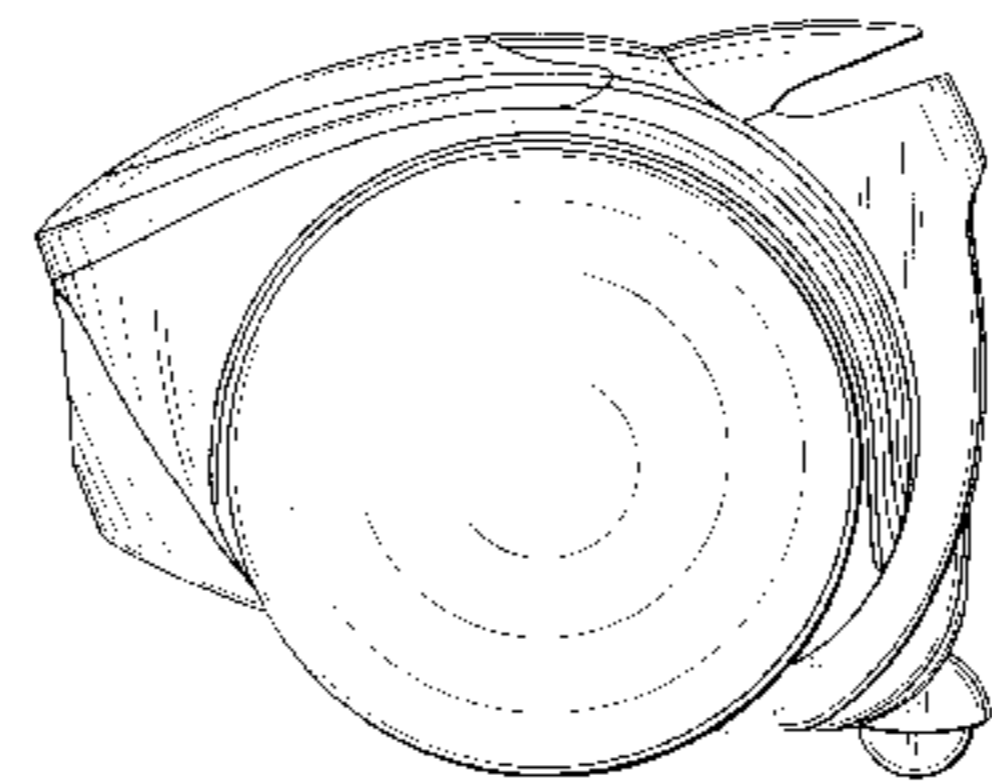
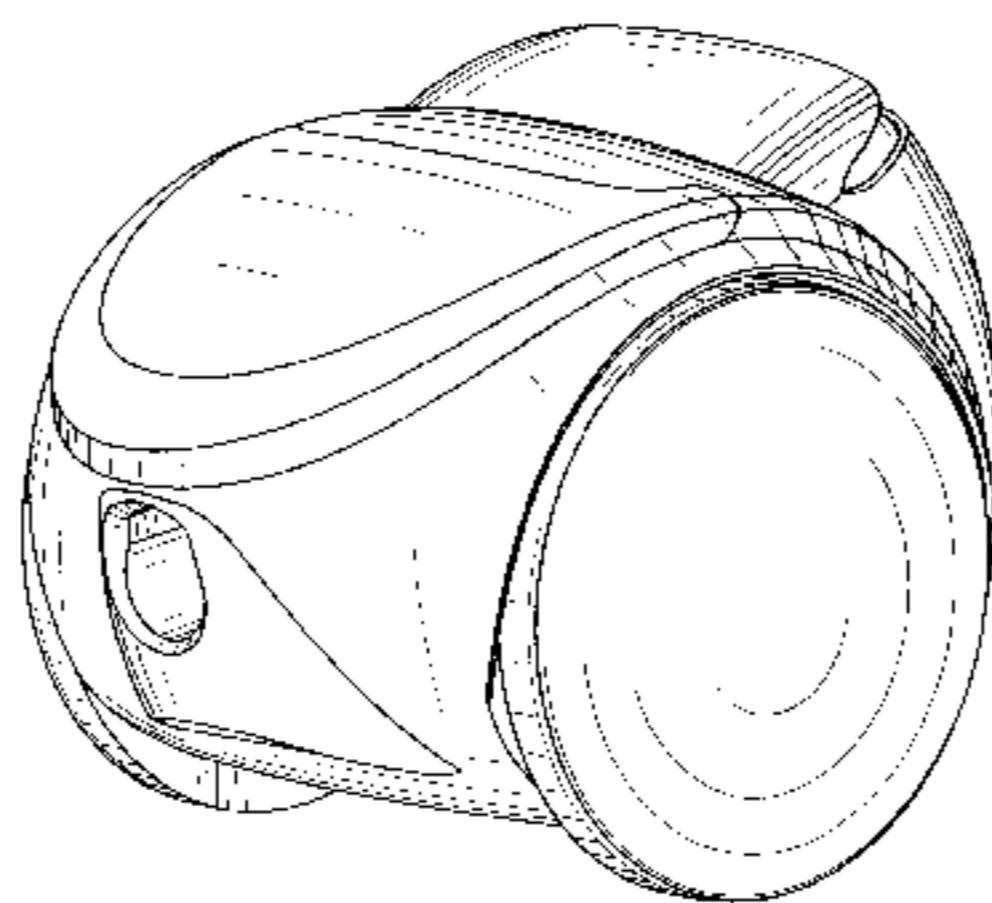

FIG. 1

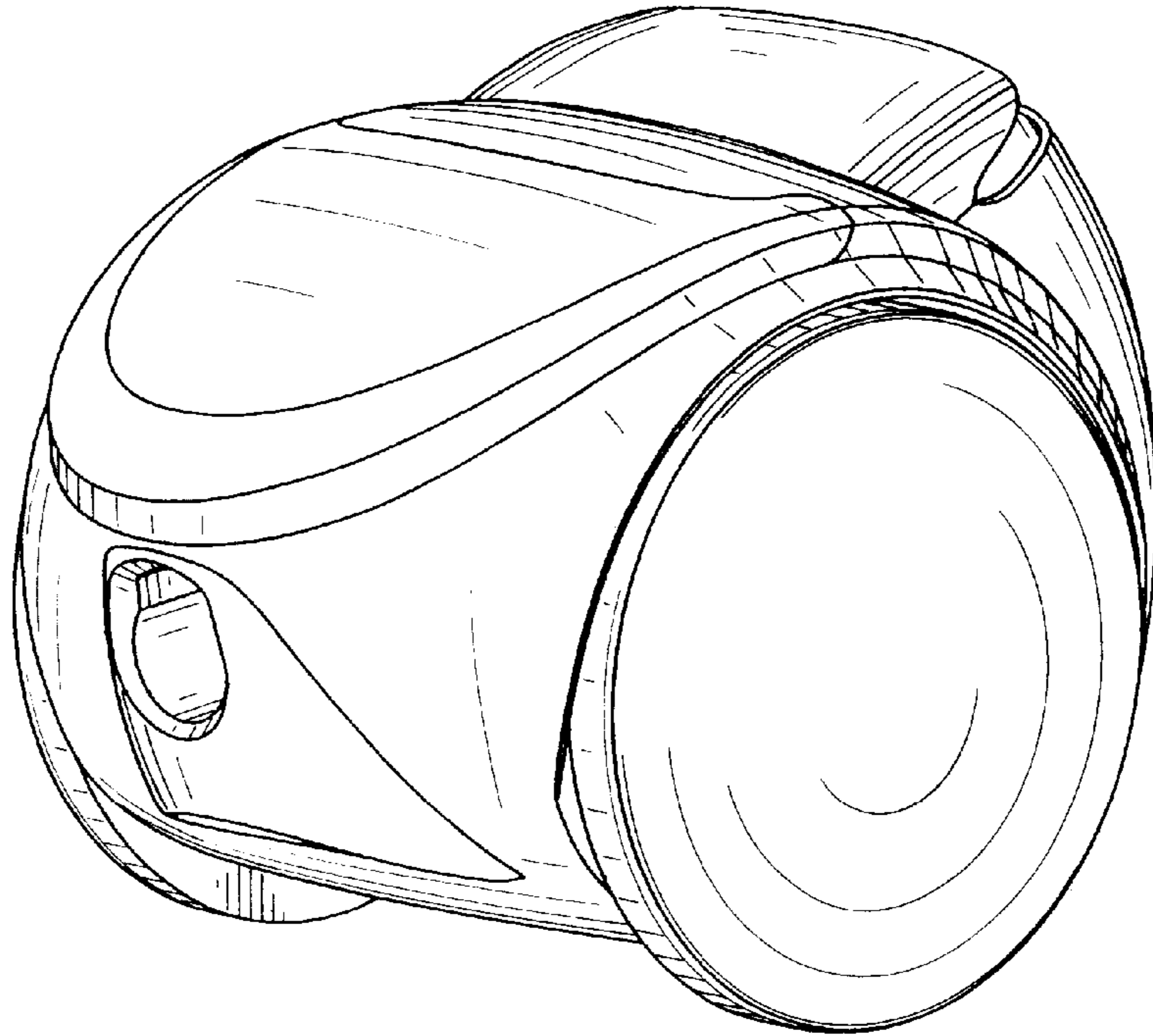

FIG. 2

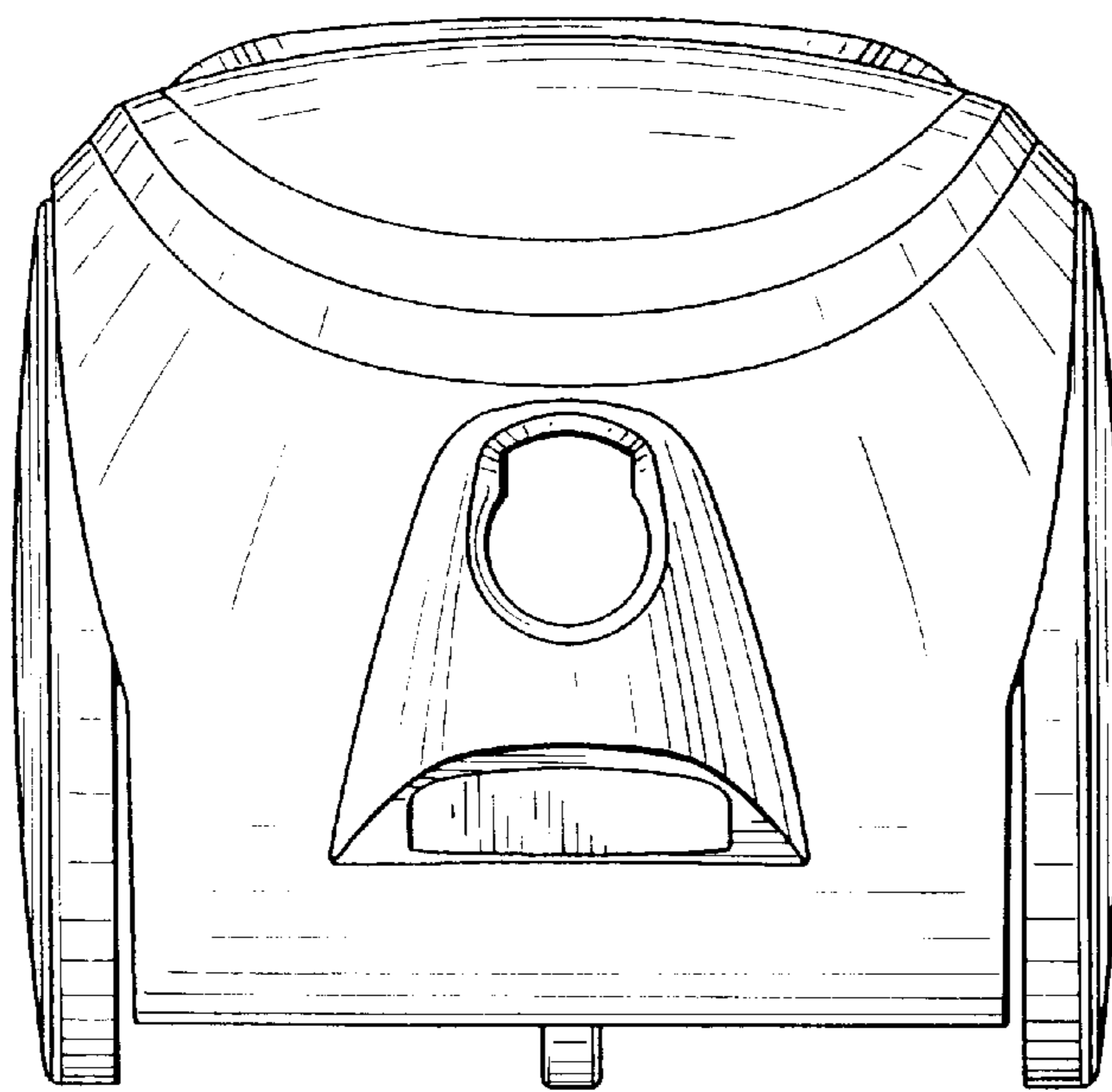

FIG. 3

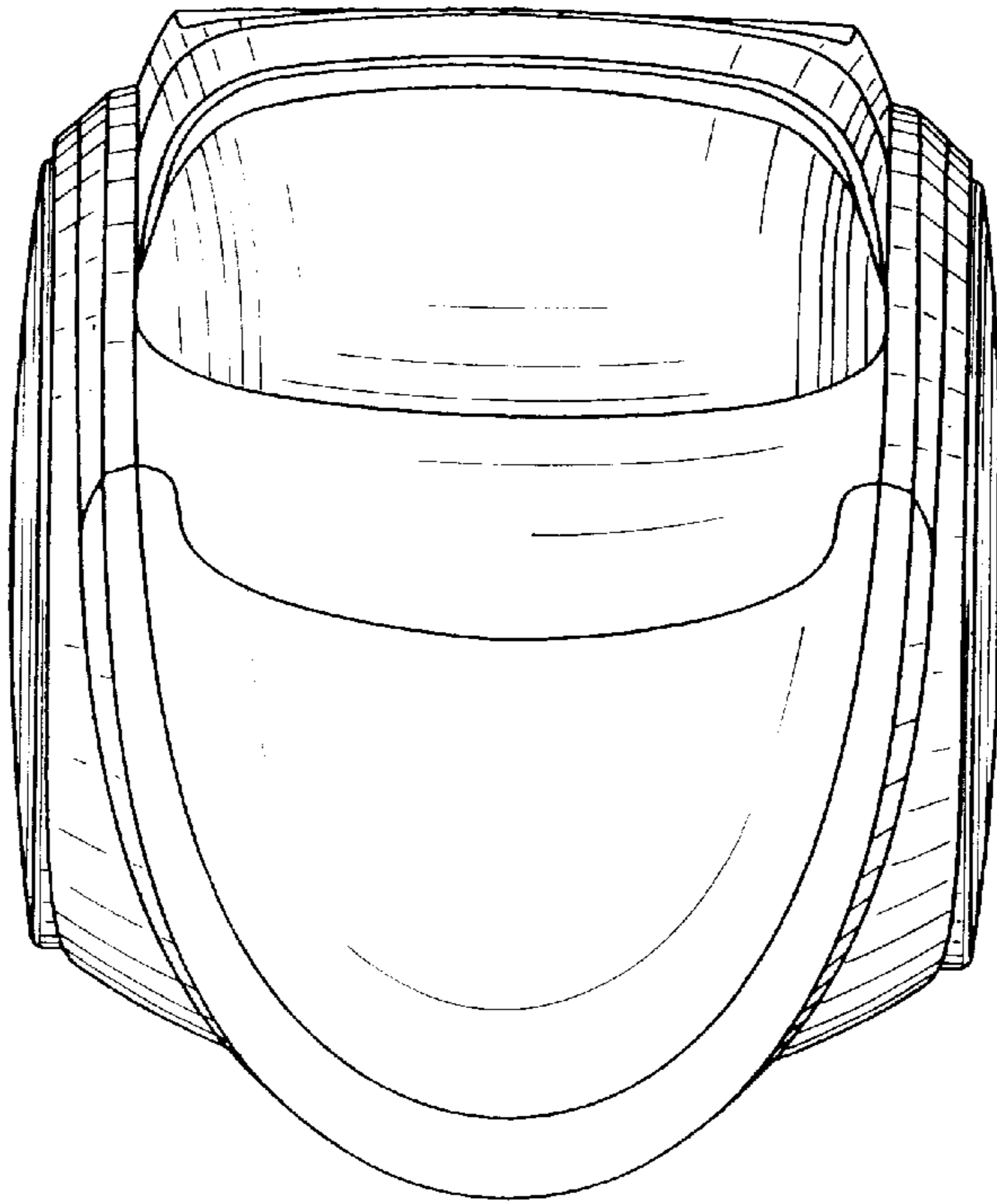

FIG. 4

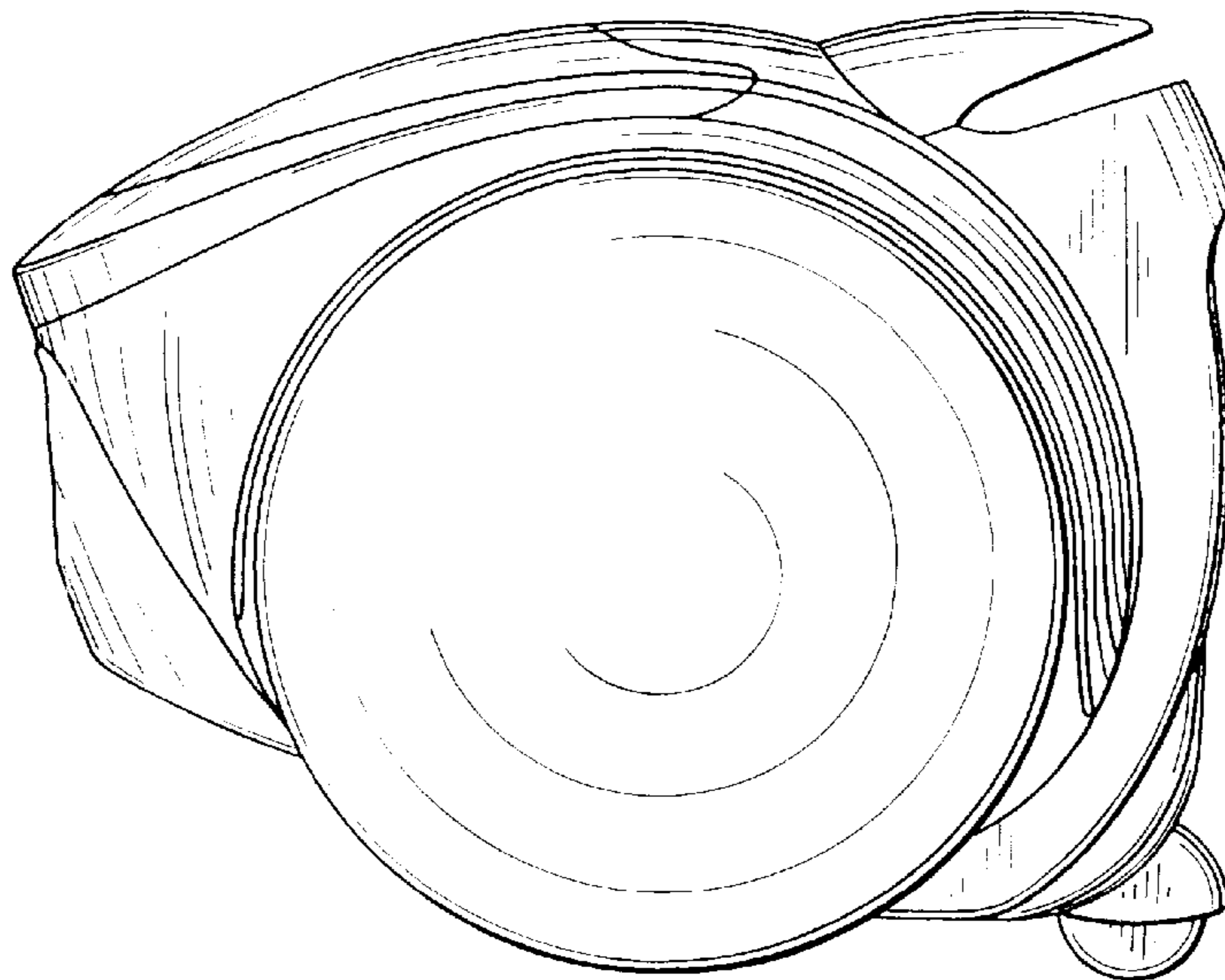

FIG. 5

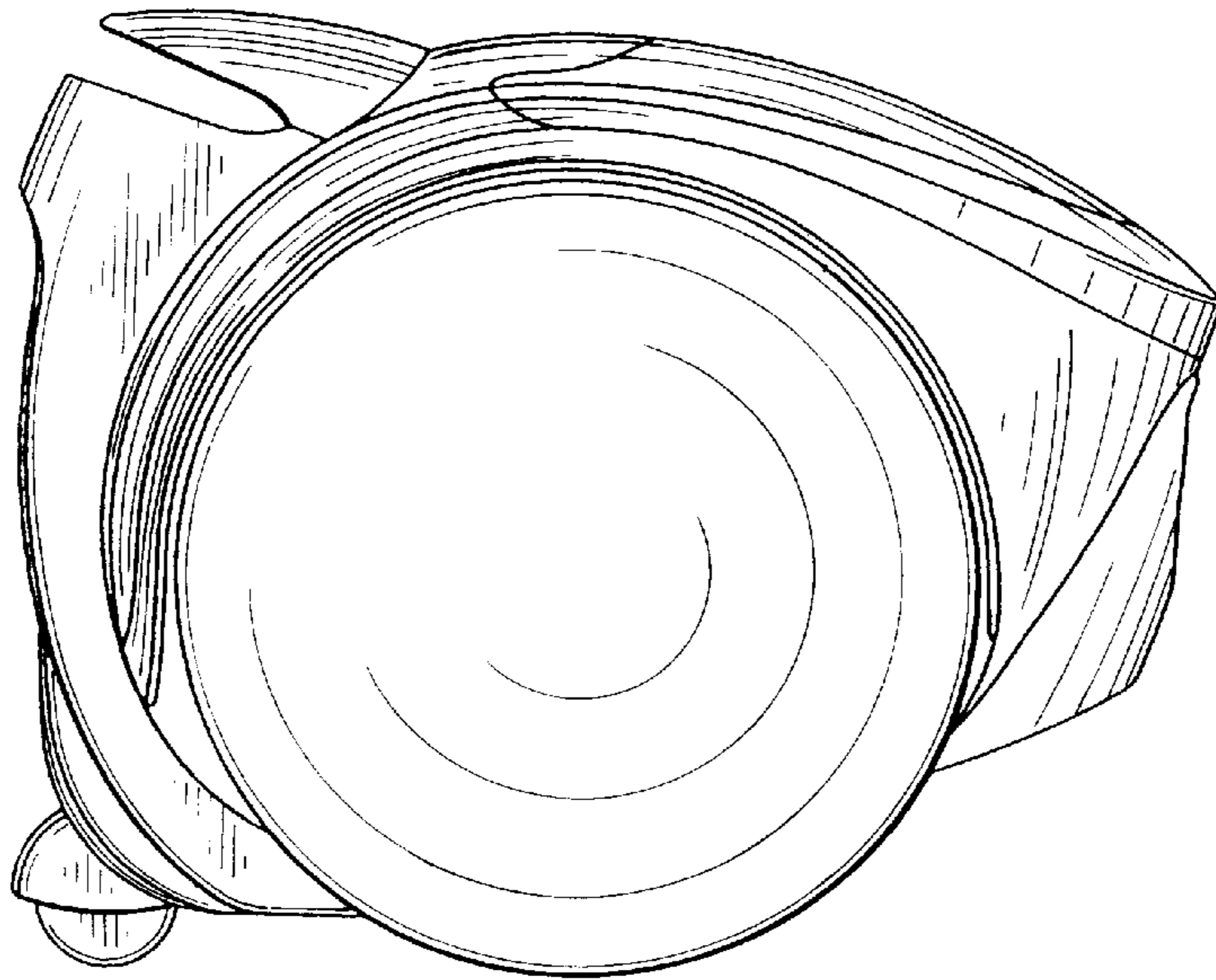

FIG. 6

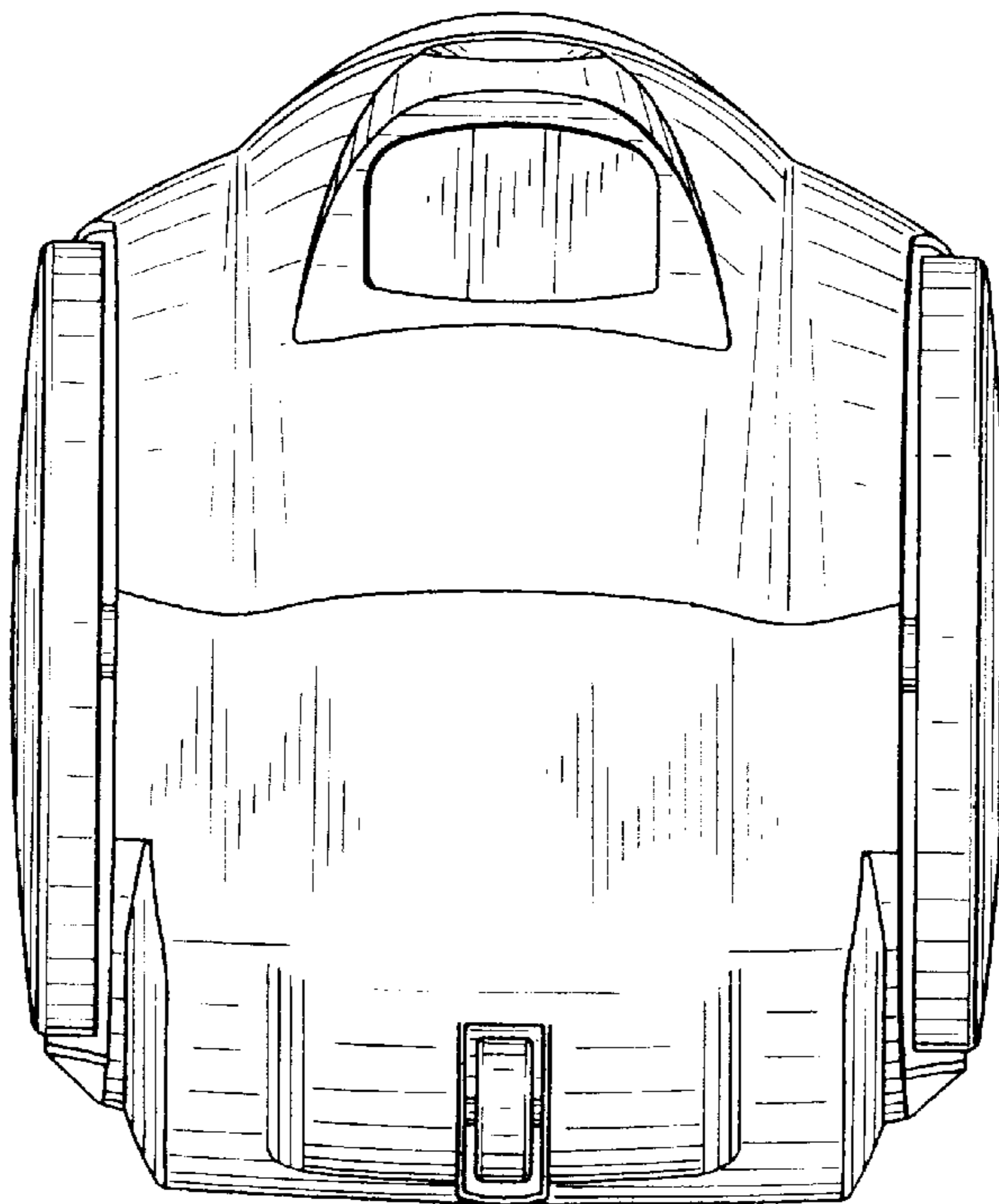

FIG. 7

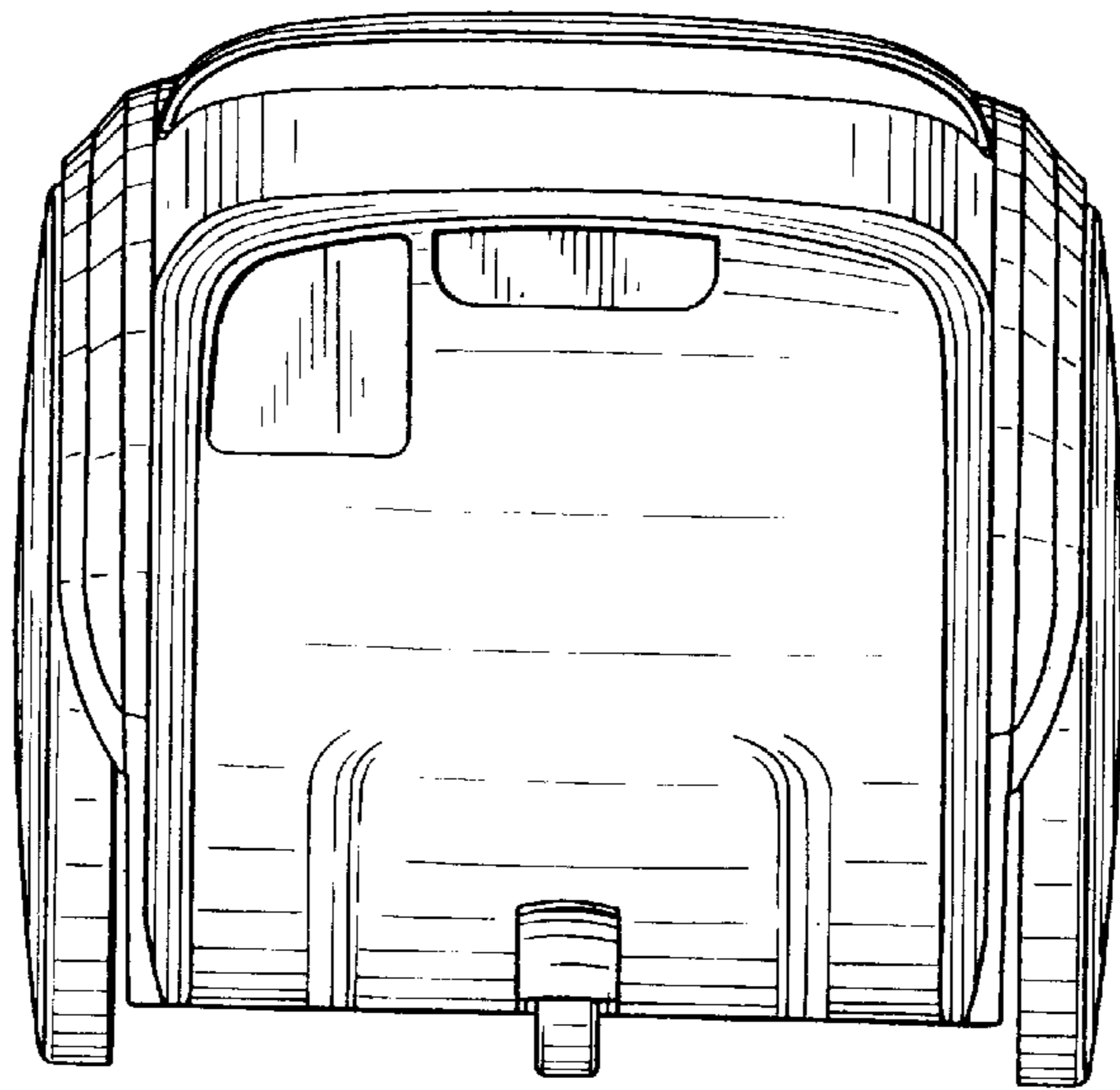

FIG. 8

