



US00D416967S

# United States Patent [19]

Ackerman

[11] Patent Number: **Des. 416,967**

[45] Date of Patent: **\*\* Nov. 23, 1999**

[54] **GOLF CLUB HEAD**

[76] Inventor: **William R. Ackerman**, 2964 Blake Ave., NW., Canton, Ohio 44718-3418

[\*\*] Term: **14 Years**

[21] Appl. No.: **29/098,193**

[22] Filed: **Dec. 22, 1998**

[51] **LOC (6) Cl.** ..... **21-02**

[52] **U.S. Cl.** ..... **D21/752**

[58] **Field of Search** ..... D21/733, 752;  
473/345, 346, 324, 327, 328, 330

[56] **References Cited**

**U.S. PATENT DOCUMENTS**

D. 352,538	11/1994	Williams, Jr.	.....	D21/752
D. 363,748	10/1995	Iinuma et al.	.....	D21/752
D. 363,750	10/1995	Reed	.....	D21/752
D. 369,392	4/1996	Adams et al.	.....	D21/733
D. 379,390	5/1997	Watanabe et al.	.....	D21/752
D. 390,616	2/1998	Maltby	.....	D21/733
D. 401,989	12/1998	Sheets et al.	.....	D21/733

*Primary Examiner*—Mitchell Siegel  
*Attorney, Agent, or Firm*—Sand & Sebolt

[57] **CLAIM**

The ornamental design for a golf club head, as shown and described.

**DESCRIPTION**

FIG. 1 is a perspective view of a golf club head showing my new design;  
 FIG. 2 is a top plan view of the golf club head of FIG. 1;  
 FIG. 3 is a front elevational view of FIG. 2;  
 FIG. 4 is a right side elevational view of FIG. 2;  
 FIG. 5 is a bottom plan view of FIG. 2;  
 FIG. 6 is a rear elevational view of FIG. 2;  
 FIG. 7 is a left side elevational view of FIG. 2;  
 FIG. 8 is a perspective view of a golf club head showing a modified design;  
 FIG. 9 is a top plan view of the golf club head of FIG. 8;  
 FIG. 10 is a front elevational view of FIG. 9;  
 FIG. 11 is a right side elevational view of FIG. 9;  
 FIG. 12 is a bottom plan view of FIG. 9;  
 FIG. 13 is a rear elevational view of FIG. 9; and,  
 FIG. 14 is a left side elevational view of FIG. 9.  
 The broken line showing of a fragmented shaft is for illustrative purposes only and forms no part of the claimed design.

**1 Claim, 6 Drawing Sheets**

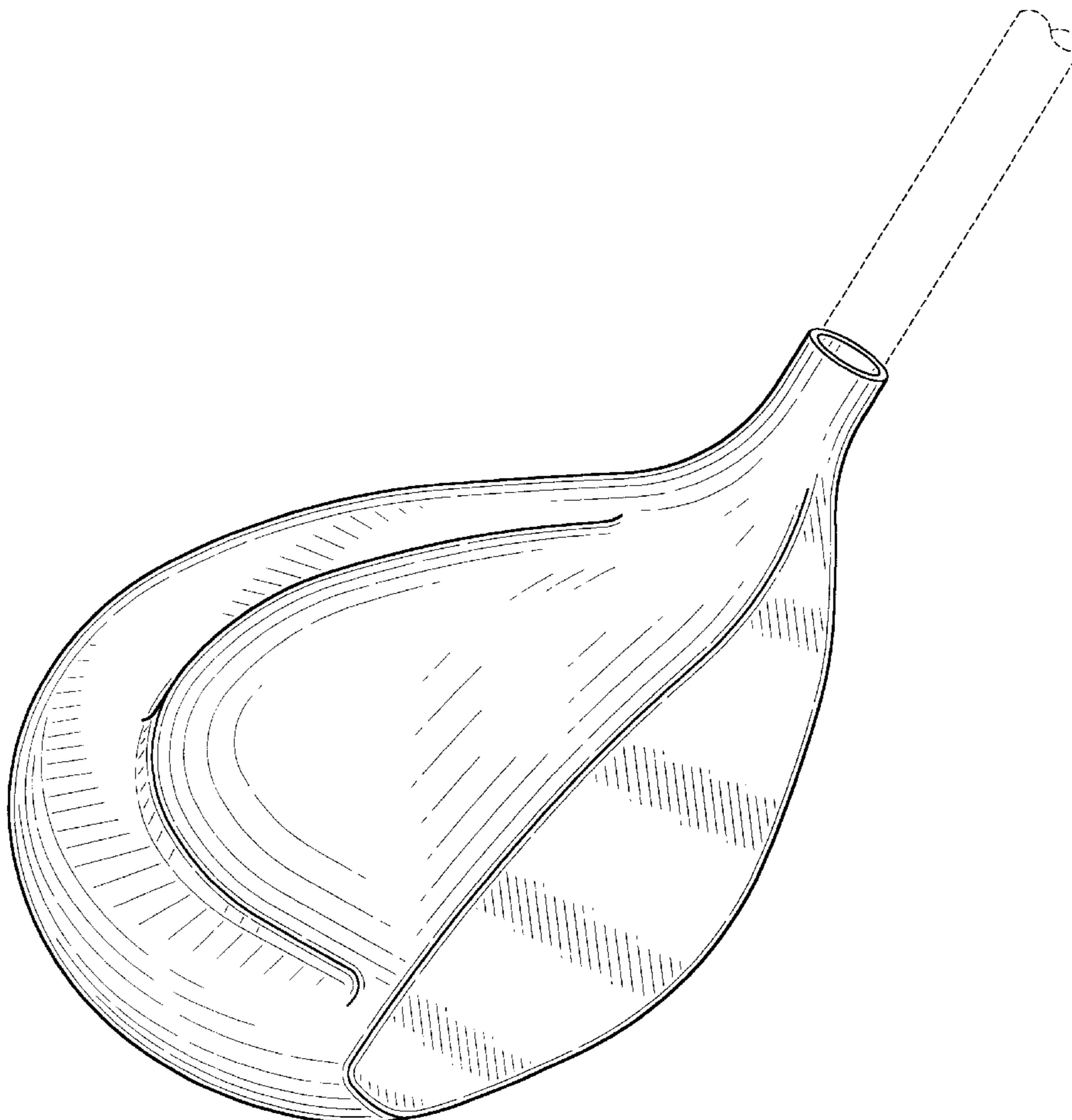

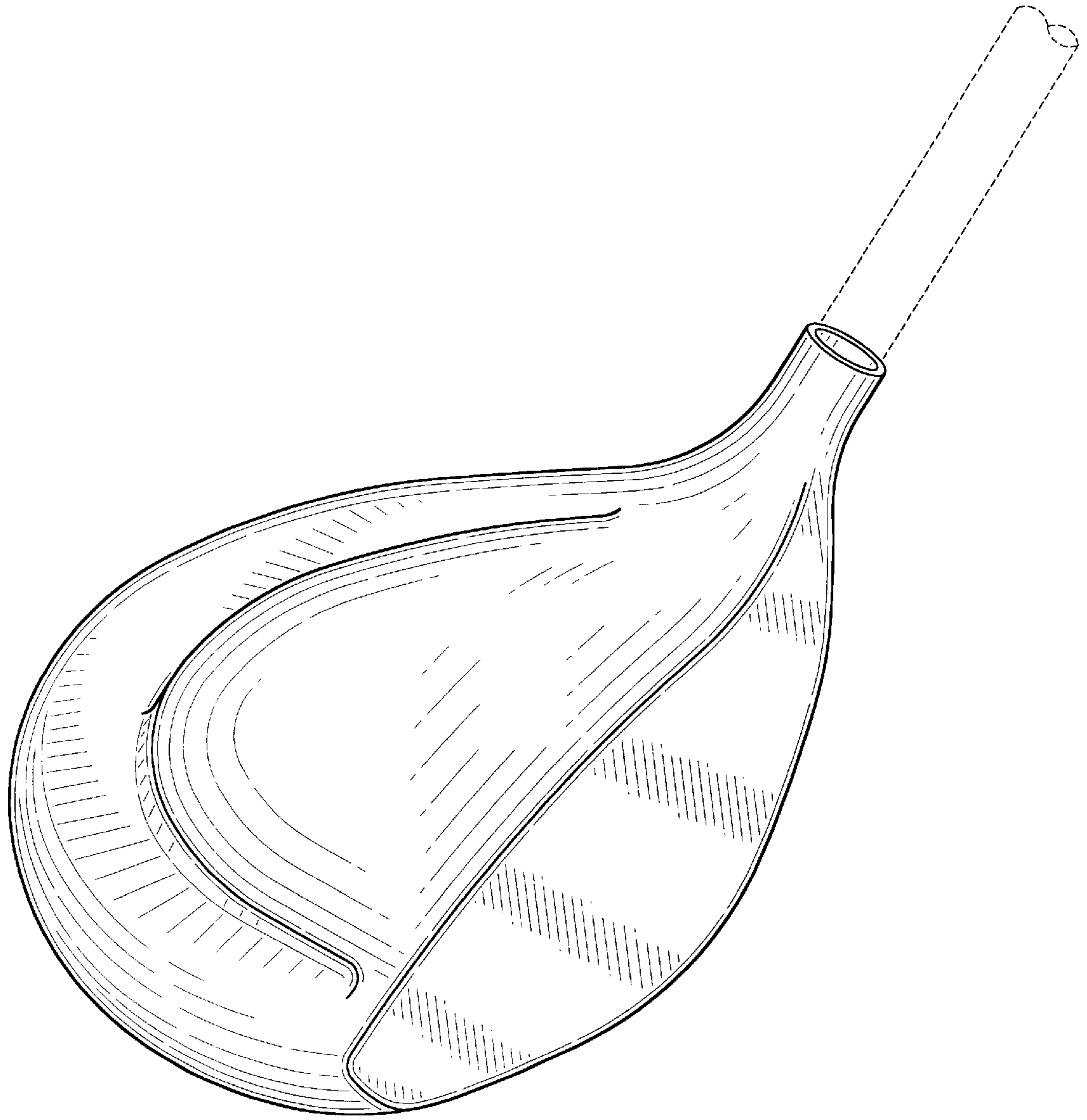

FIG-1

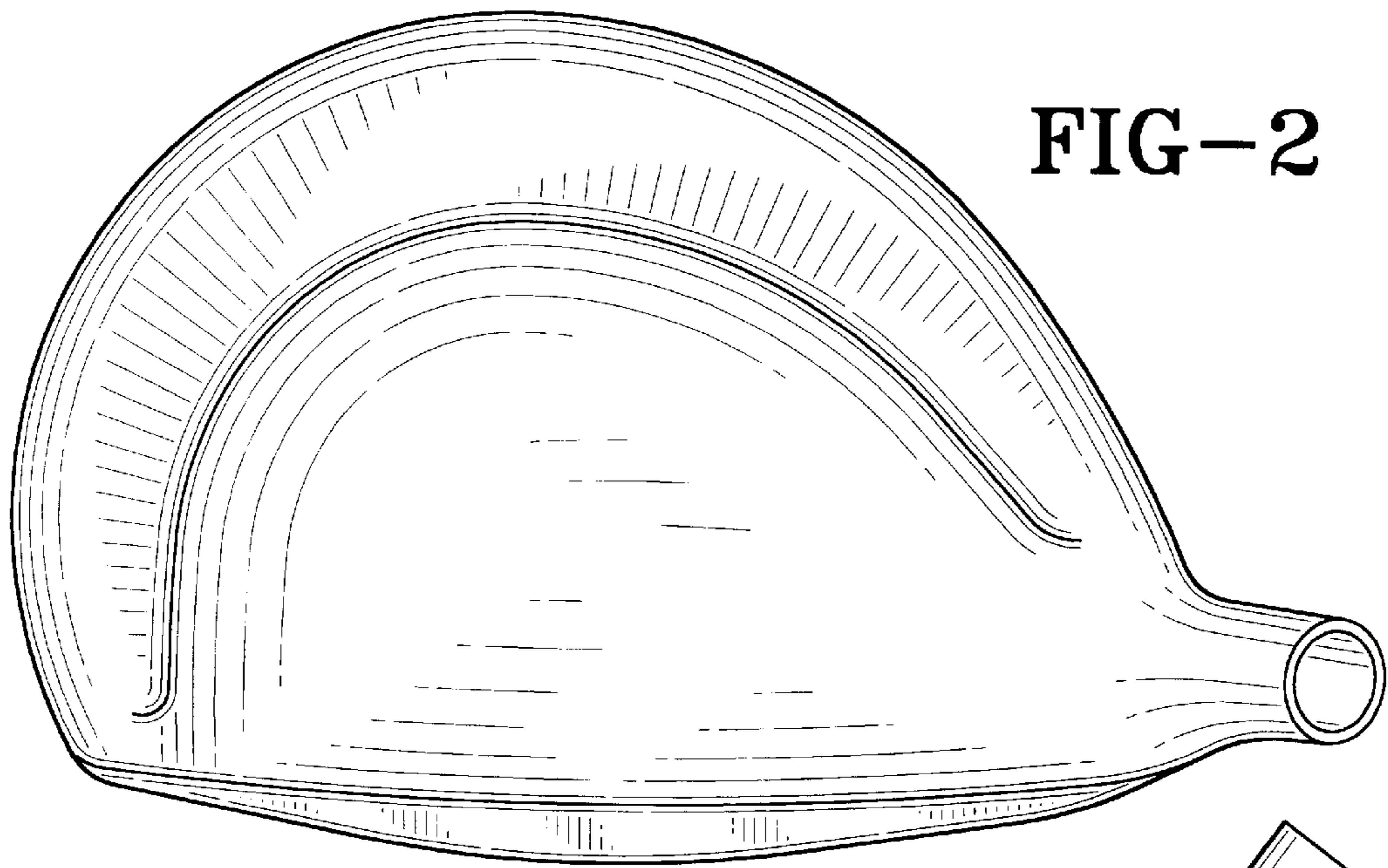

FIG-2

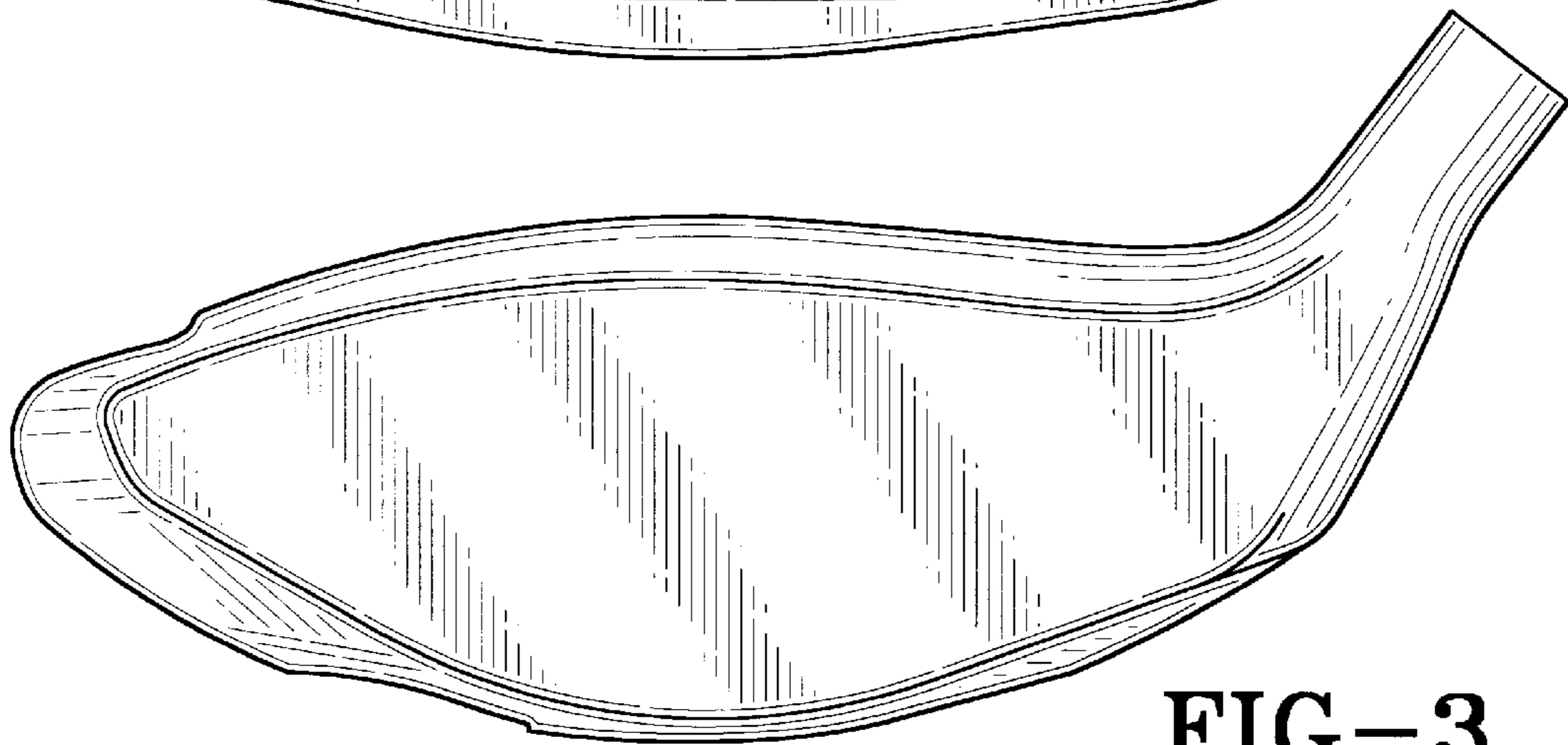

FIG-3

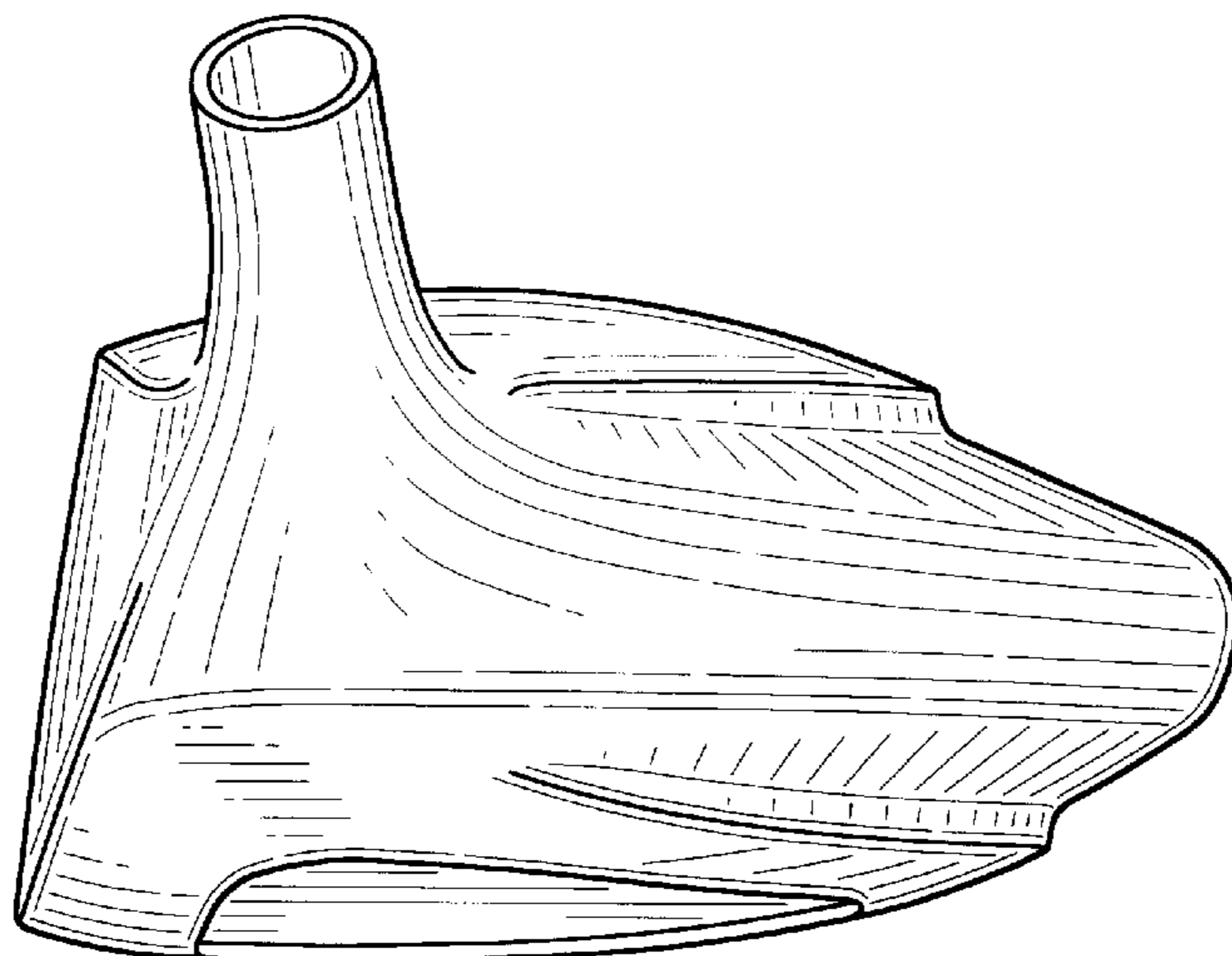

FIG-4

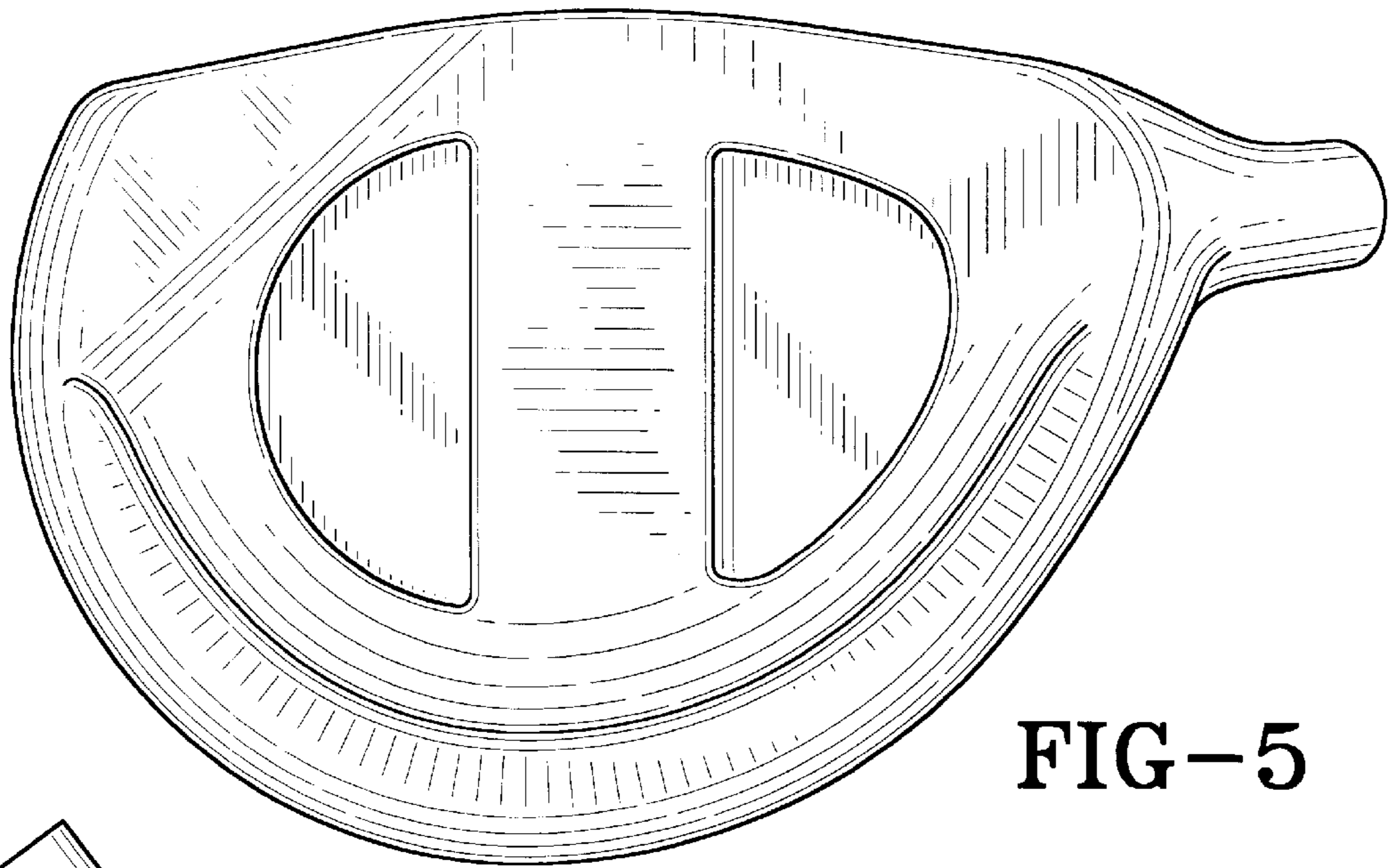

FIG-5

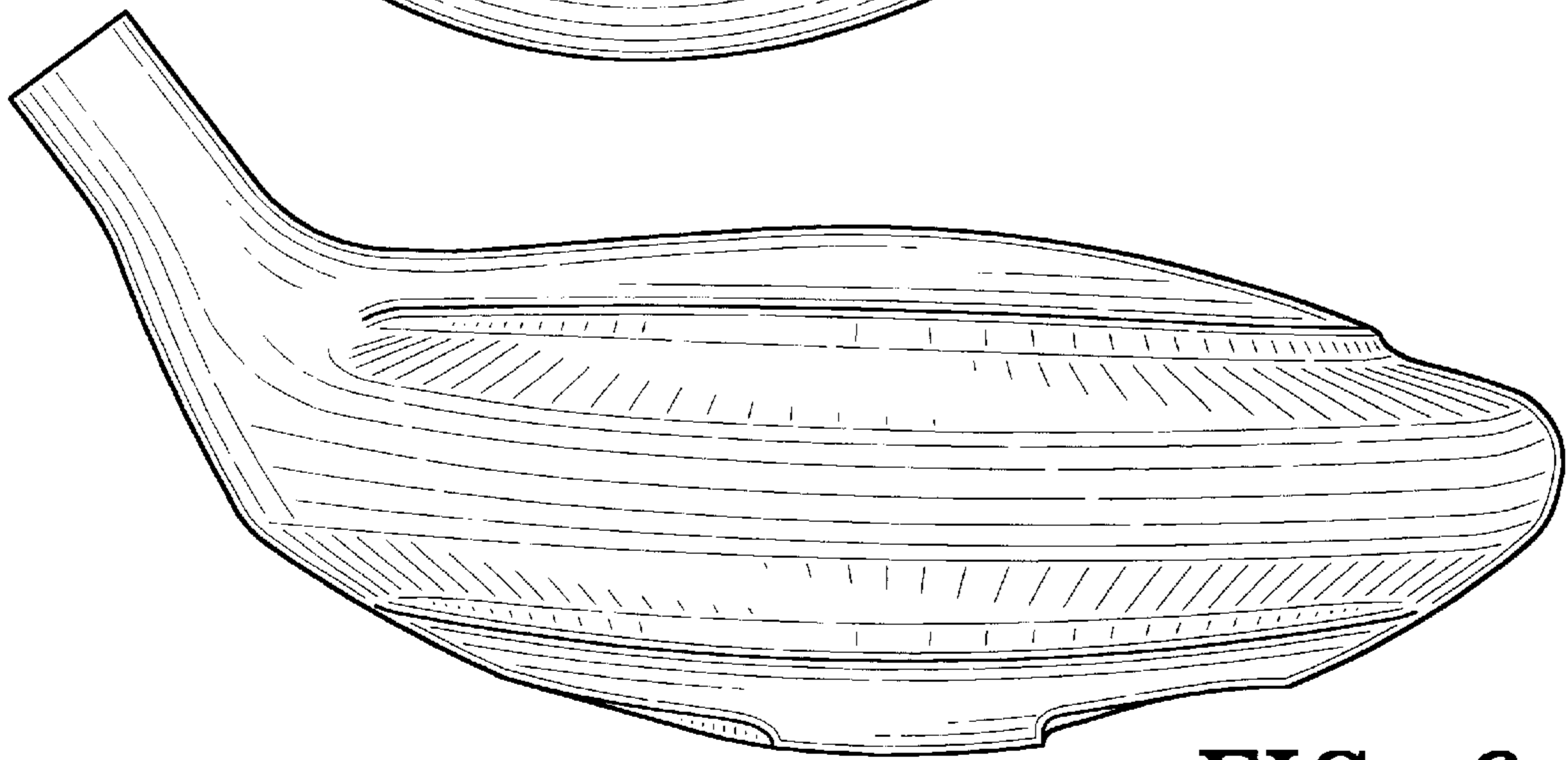

FIG-6

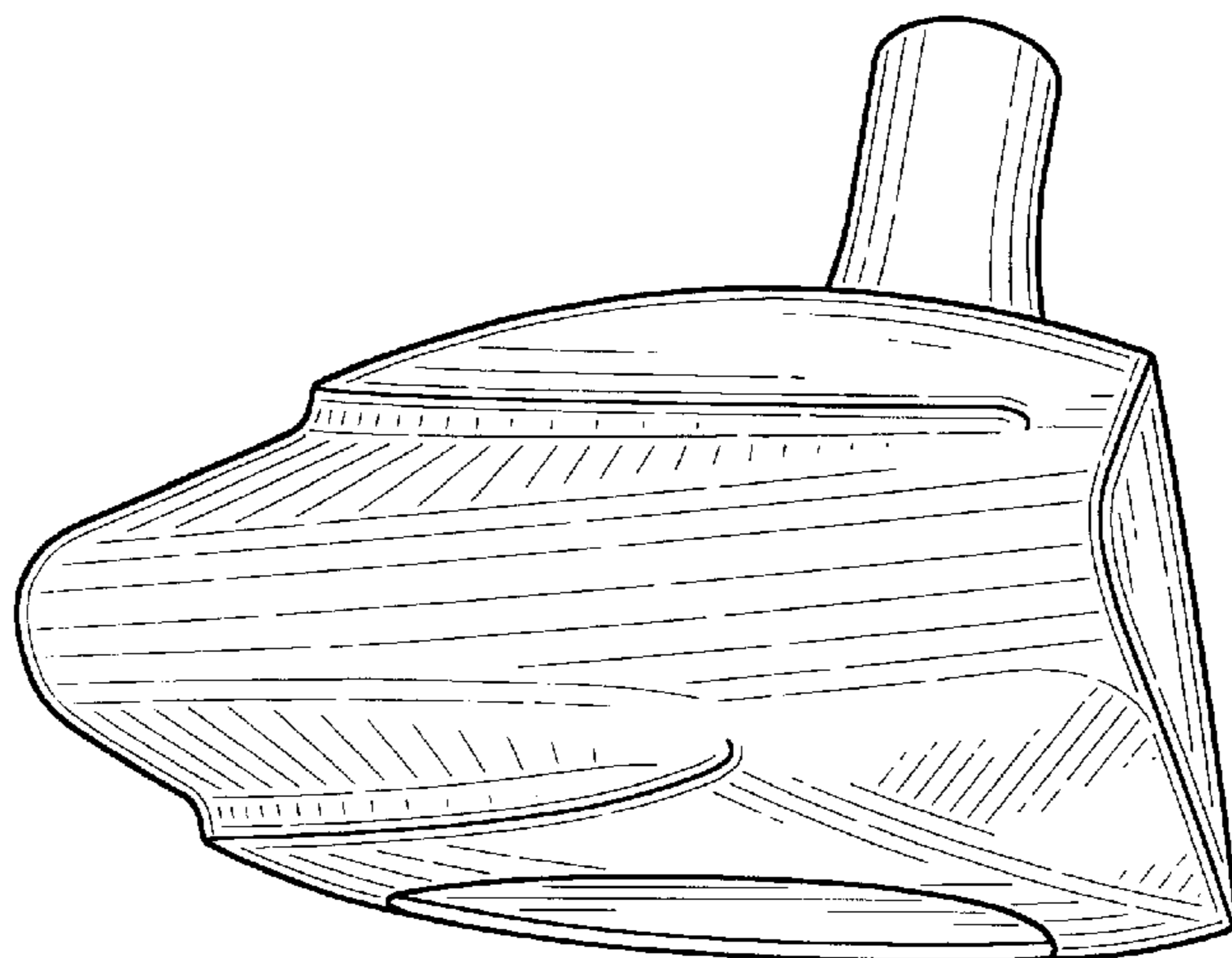

FIG-7

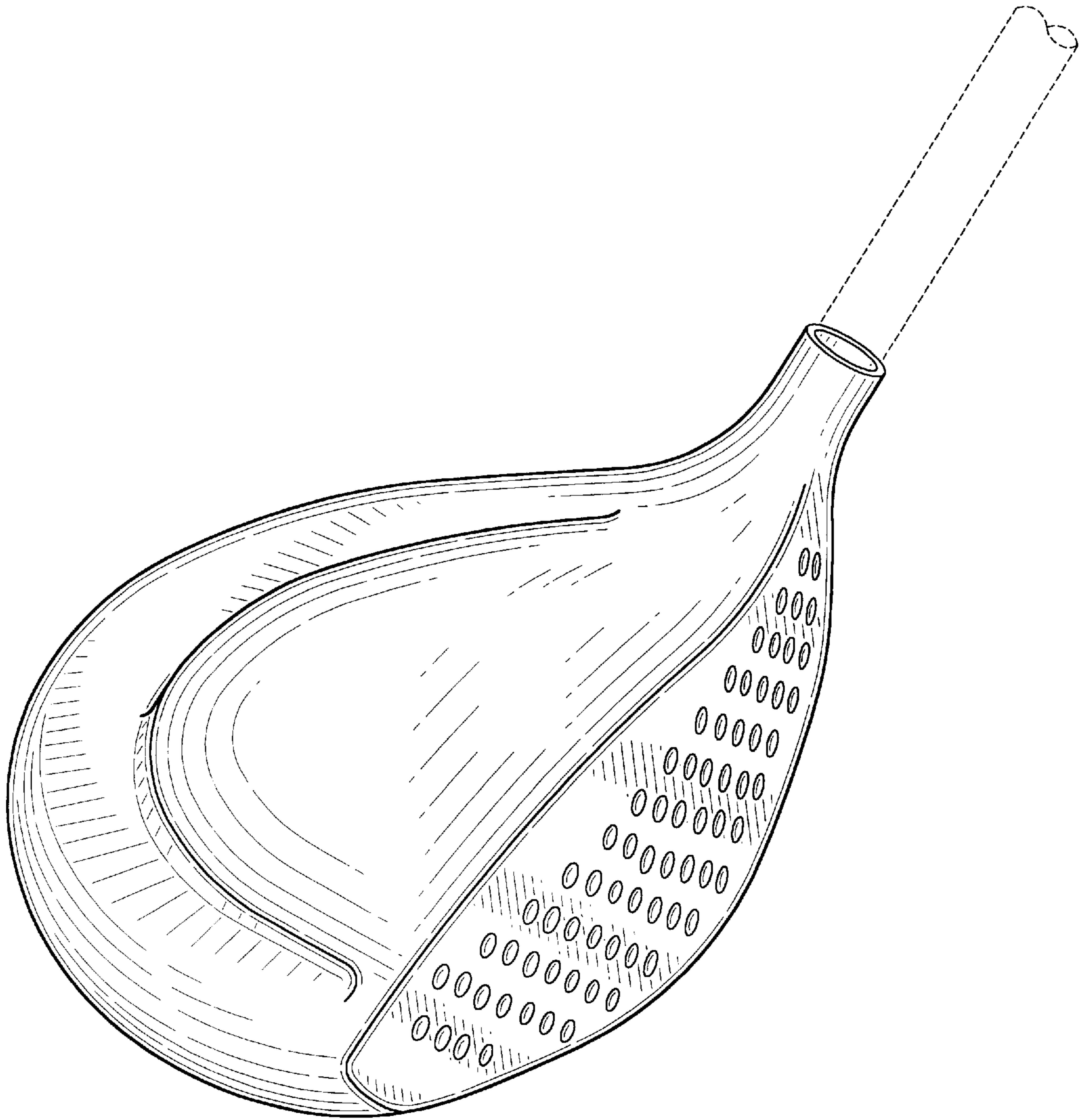

FIG-8

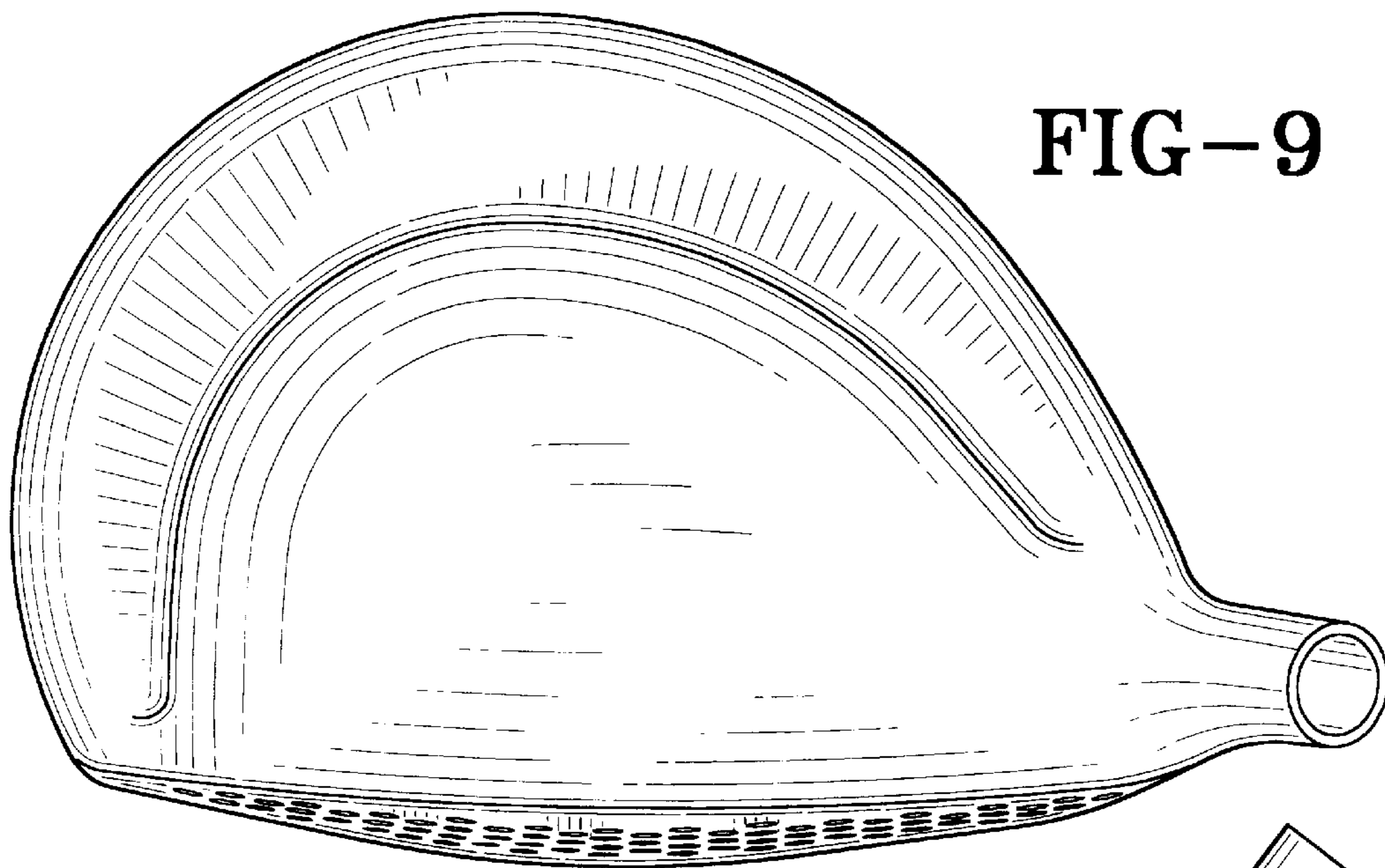

FIG-9

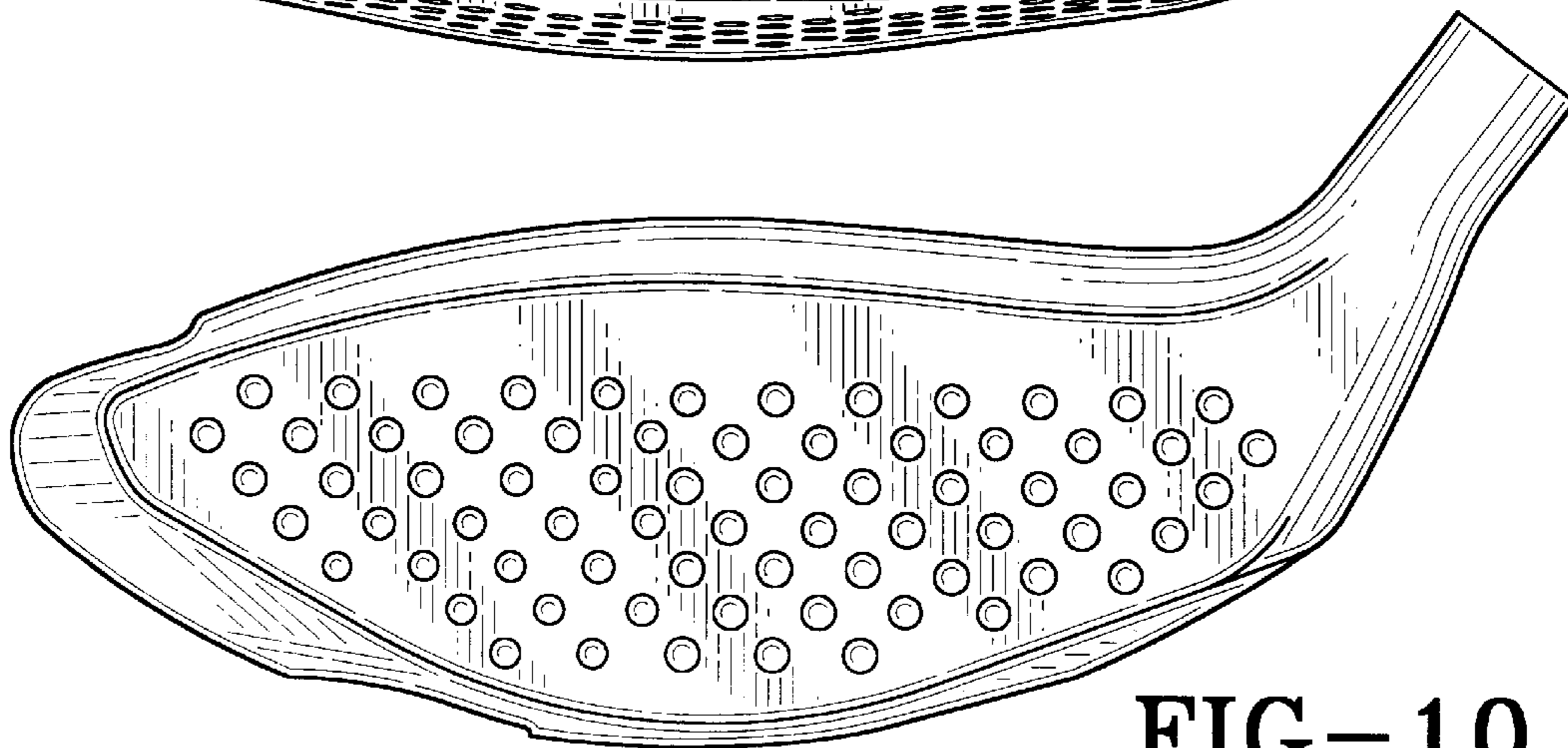

FIG-10

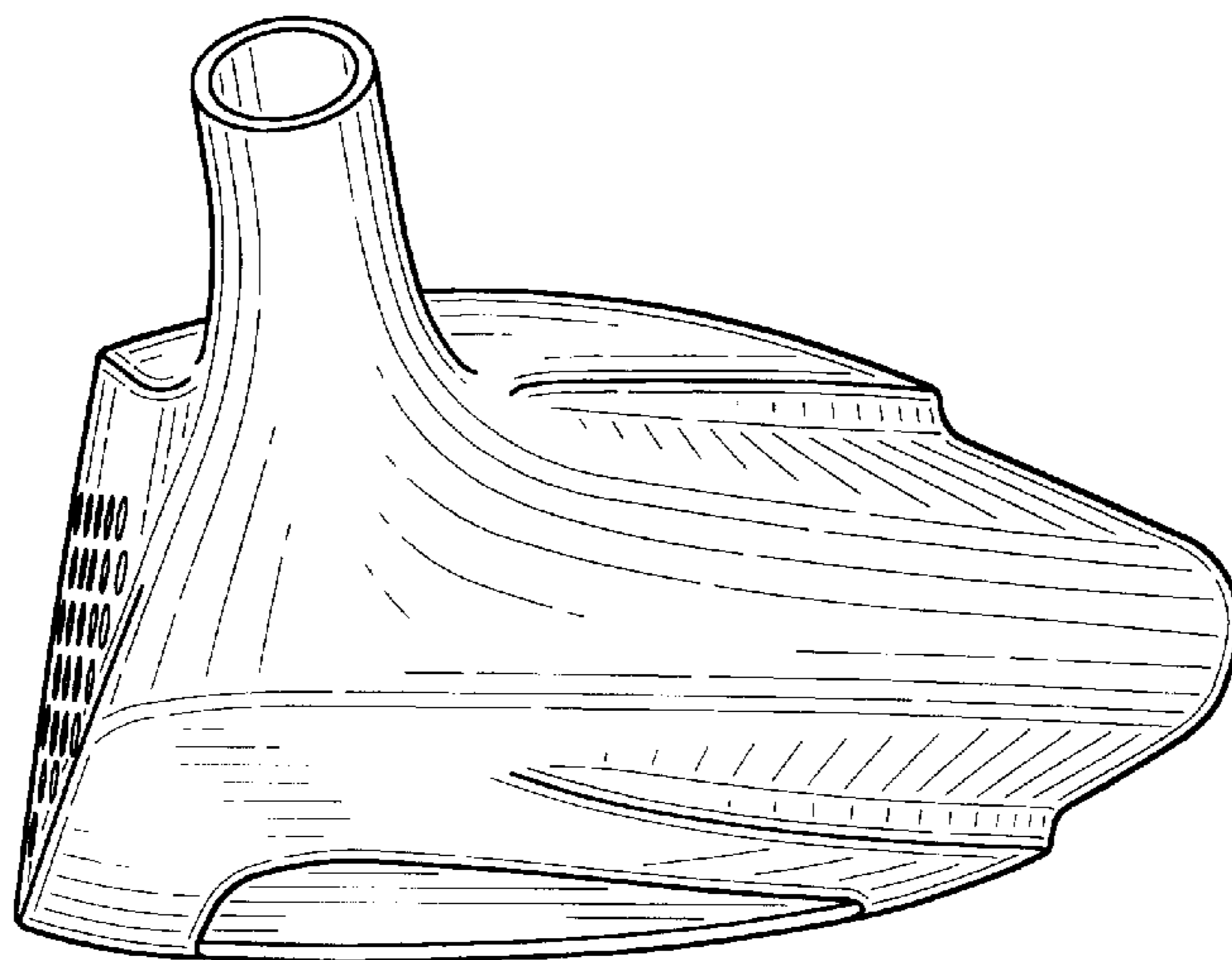

FIG-11

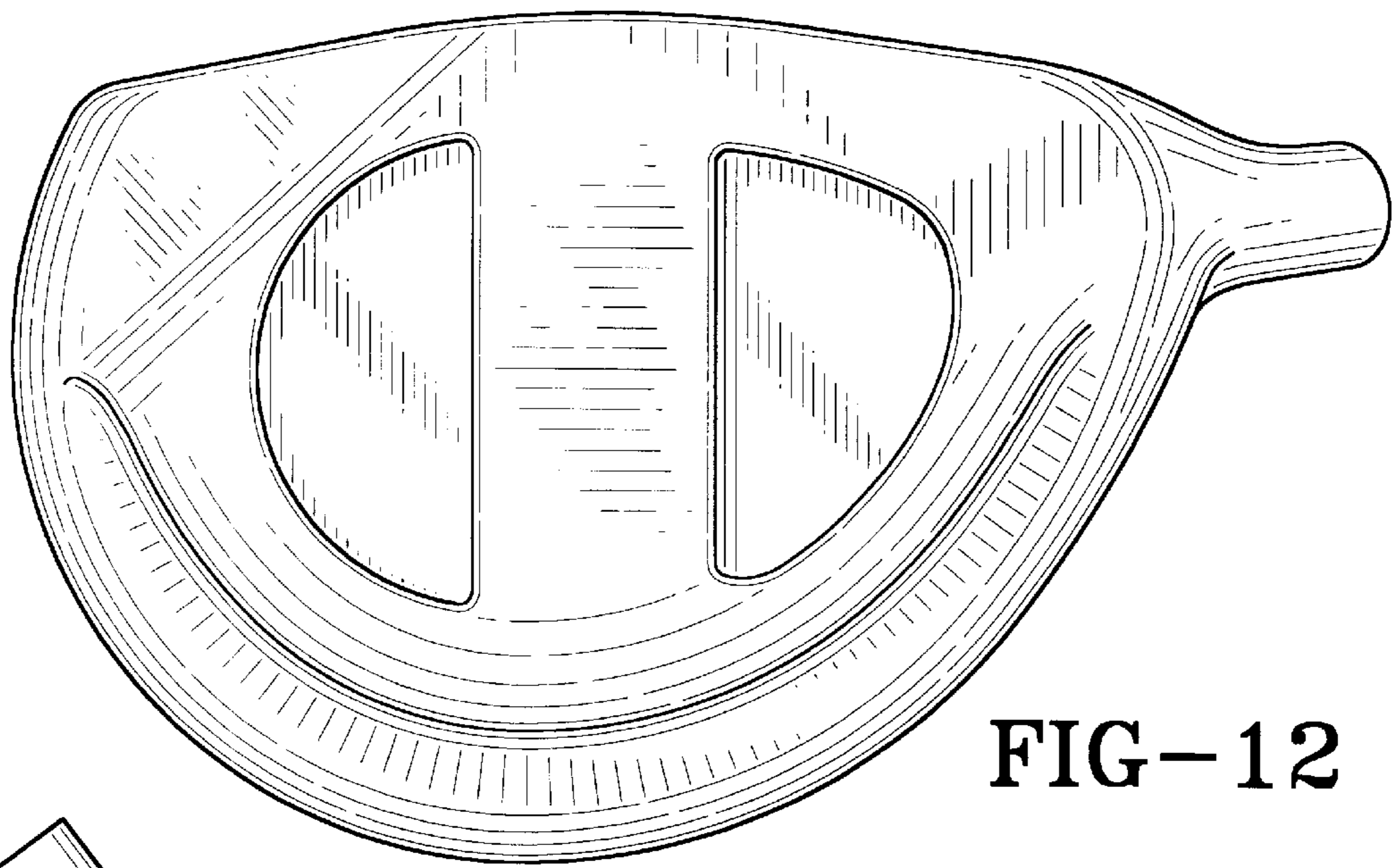

FIG-12

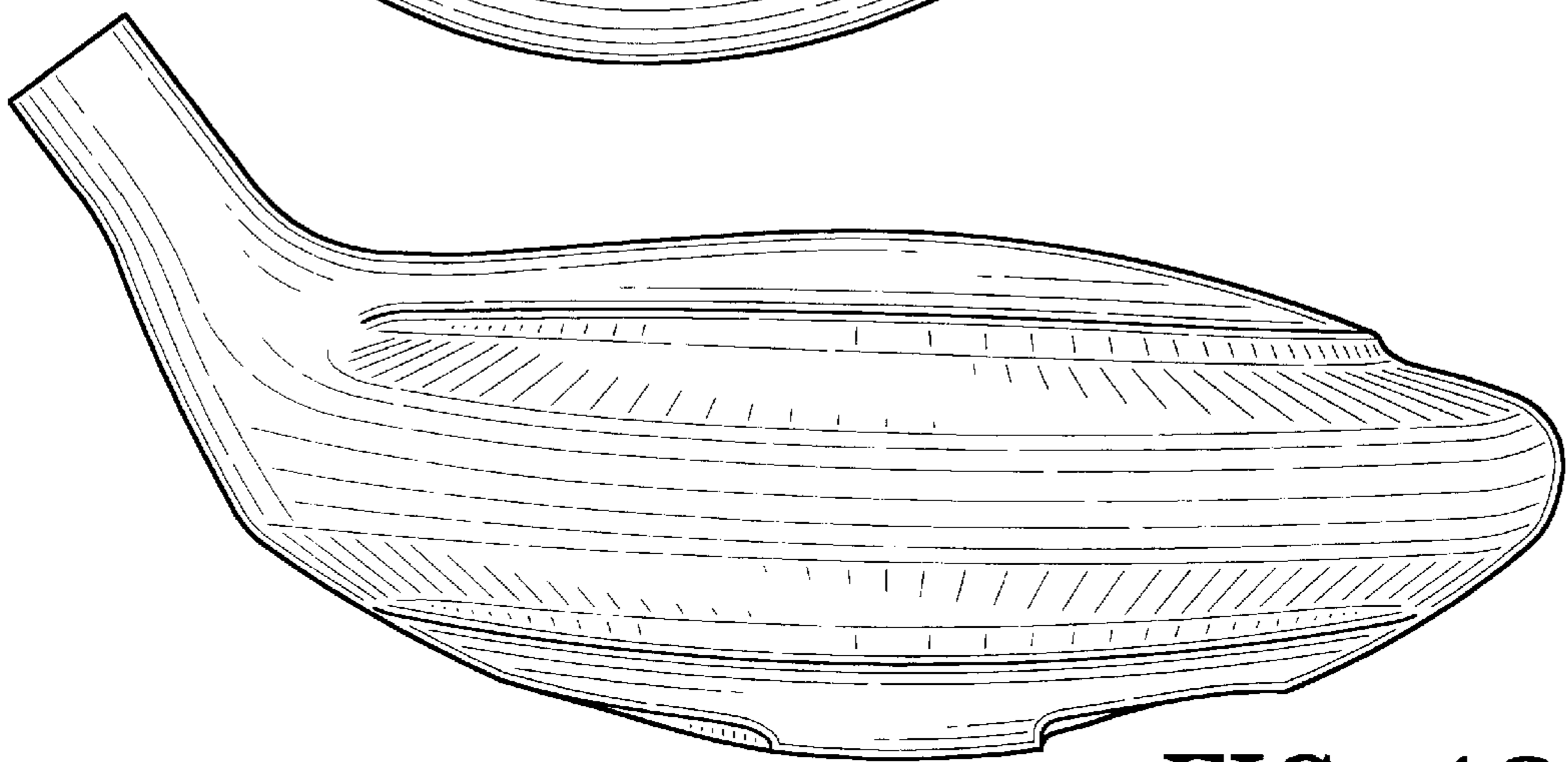

FIG-13

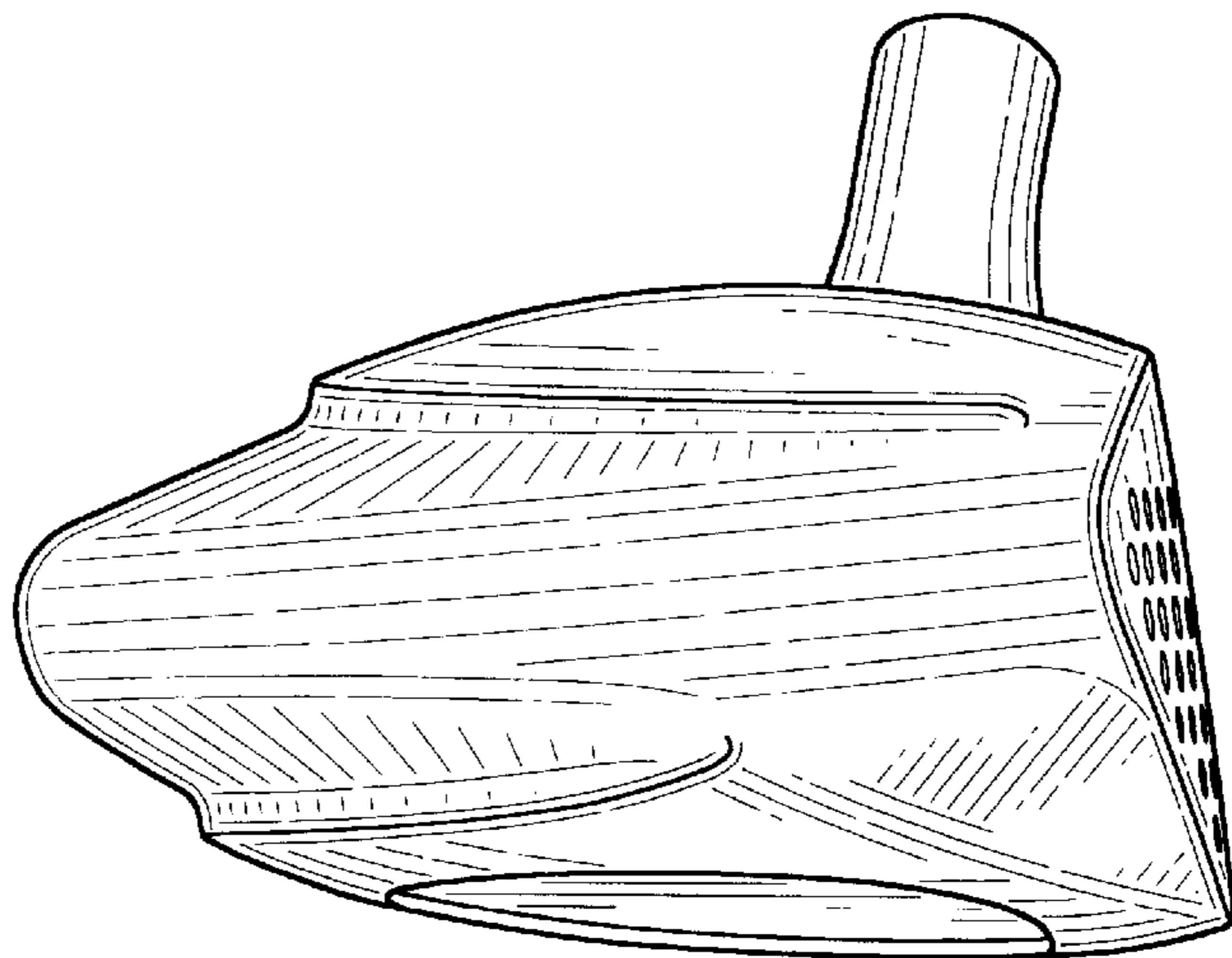

FIG-14