



US00D416911S

United States Patent [19]

[11] **Patent Number: Des. 416,911**

Takahashi et al.

[45] **Date of Patent: ** Nov. 23, 1999**

[54] REMOTE CONTROLLER FOR VIDEO TAPE RECORDER

[75] Inventors: **Masami Takahashi; Norihiko Shimose**, both of Ehime, Japan

[73] Assignee: **Matsushita Electric Industrial Co., Ltd.**, Japan

[**] Term: **14 Years**

[21] Appl. No.: **29/100,775**

[22] Filed: **Feb. 18, 1999**

[30] Foreign Application Priority Data

Sep. 3, 1998 [JP] Japan 10-25244

[51] **LOC (6) Cl.** **14-03**

[52] **U.S. Cl.** **D14/218**

[58] **Field of Search** D14/124, 217, D14/218, 299; D10/104, 106; D13/168; D21/333; 348/734; 455/151.1, 151.4, 152.1, 352-355; 200/331

[56] References Cited

U.S. PATENT DOCUMENTS

D. 376,366	12/1996	Patton et al.	D14/218
D. 382,878	8/1997	Erlin	D14/218
D. 386,185	11/1997	Cho	D14/218
D. 398,009	9/1998	Huppertz et al.	D14/218
D. 407,071	3/1999	Keating	D13/168

OTHER PUBLICATIONS

RCA Home Control, Satellite, NITEglo, and SystemLink universal remotes, catalog issued before Sep. 3, 1998, one unnumbered page.

JVC Video Cassette Recorder Model Nos. HR-DD840, HR-DD750, HR-VP654, HR-VP650, HR-A54, HR-VP450, HR-A34, catalog issued before Sep. 3, 1998, one unnumbered page.

Primary Examiner—Louis S. Zarfes

Assistant Examiner—G. Andoll

Attorney, Agent, or Firm—Saidman DesignLaw Group

[57] CLAIM

The ornamental design for a remote controller for video tape recorder, as shown and described.

DESCRIPTION

FIG. 1 is a perspective view of the top, front and right side of a remote controller for video tape recorder showing our new design;

FIG. 2 is a perspective view of the top, rear and right side thereof;

FIG. 3 is a front view thereof;

FIG. 4 is a rear view thereof;

FIG. 5 is a left side view thereof;

FIG. 6 is a right side view thereof;

FIG. 7 is a top plan view thereof; and,

FIG. 8 is a bottom view thereof.

1 Claim, 3 Drawing Sheets

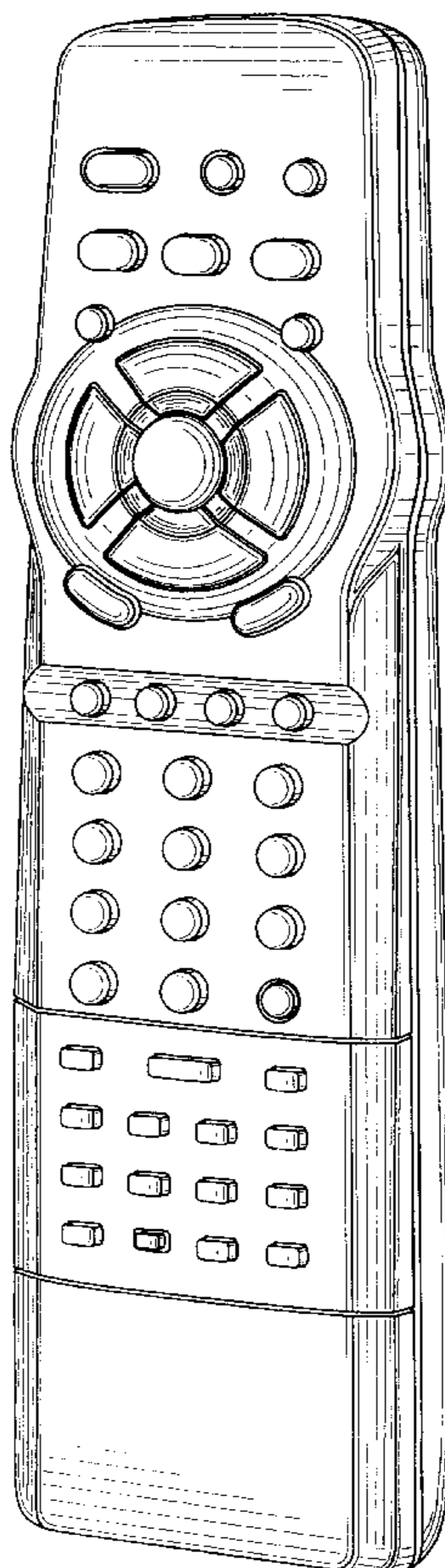

FIG. 1

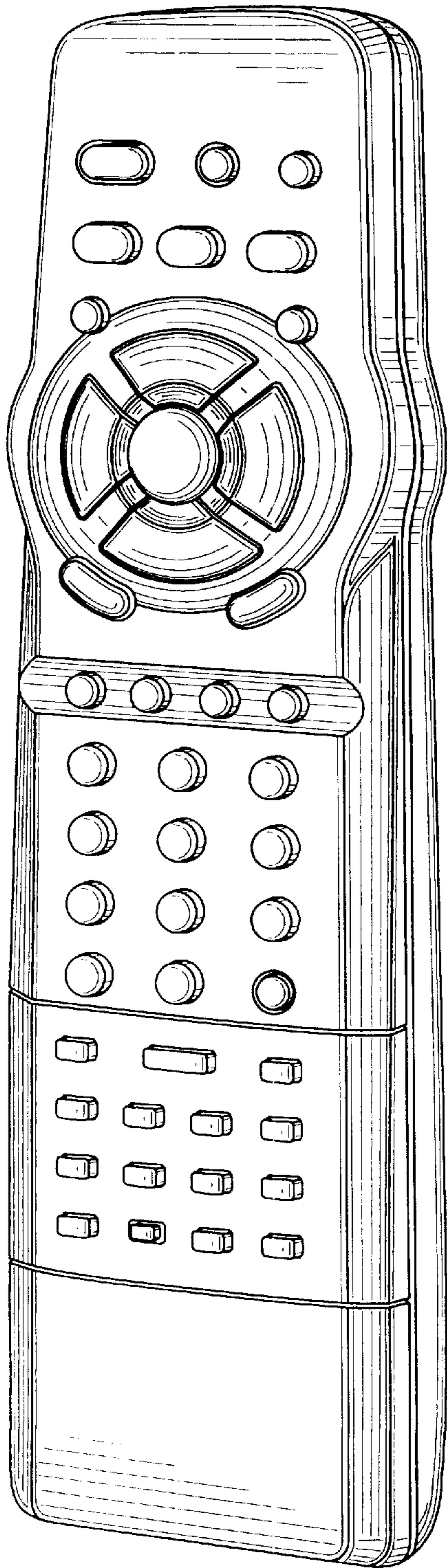

FIG. 2

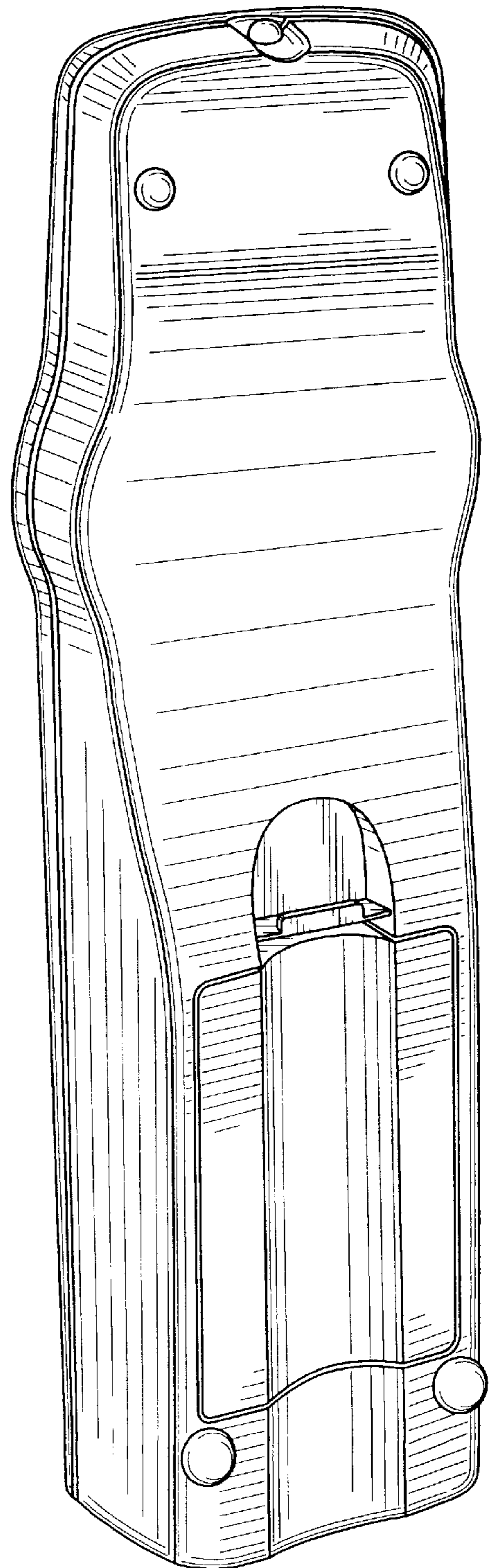

FIG. 3

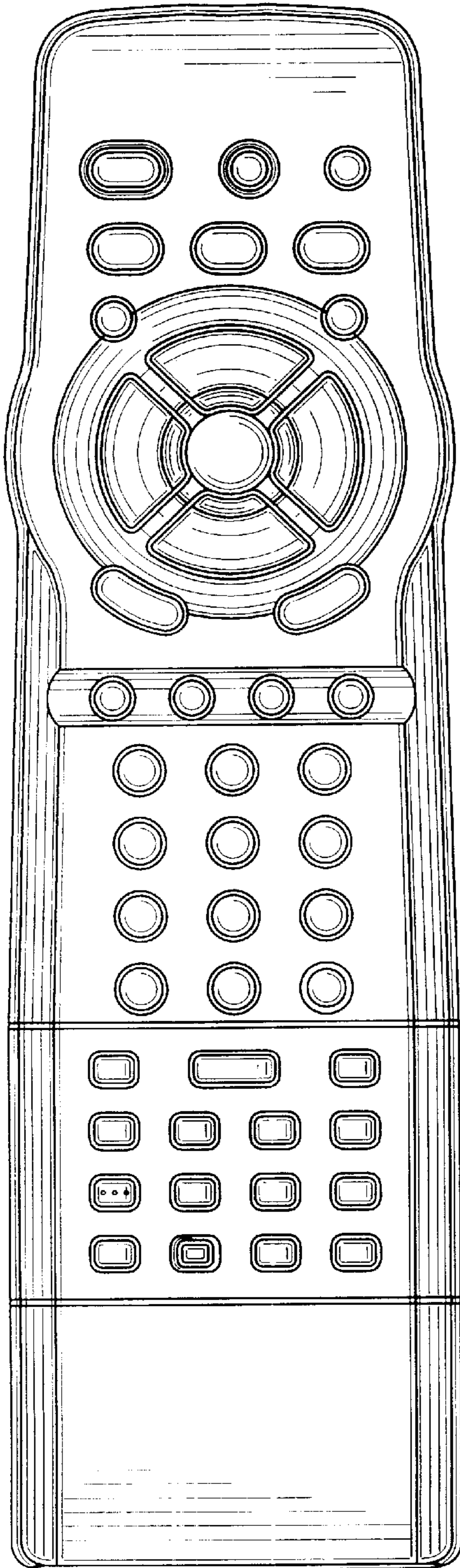

FIG. 4

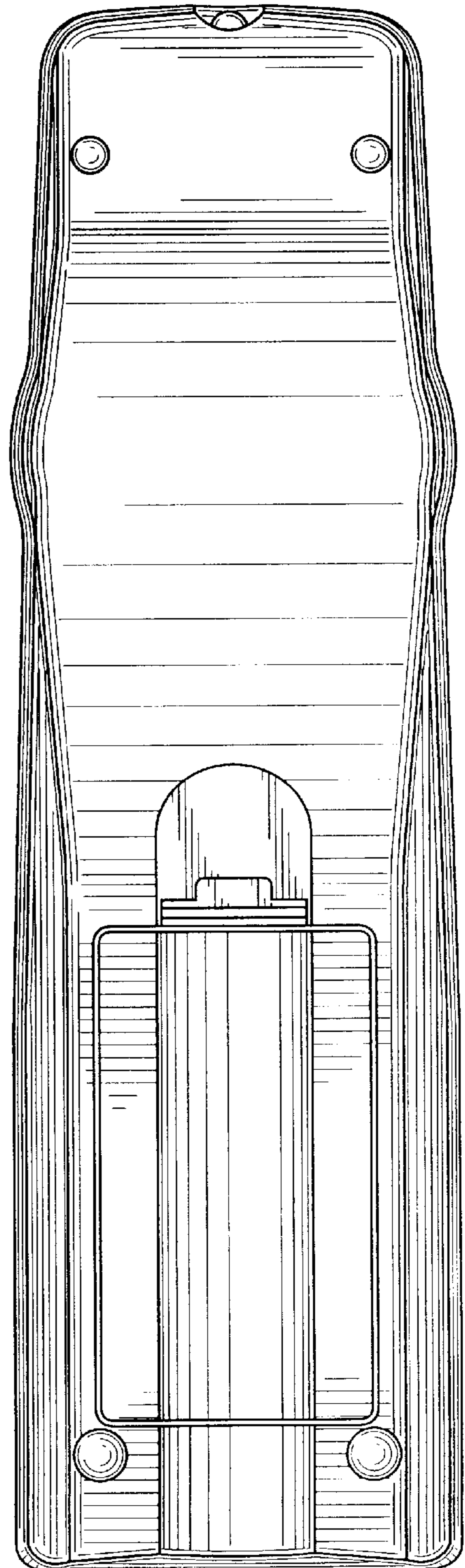

FIG. 5

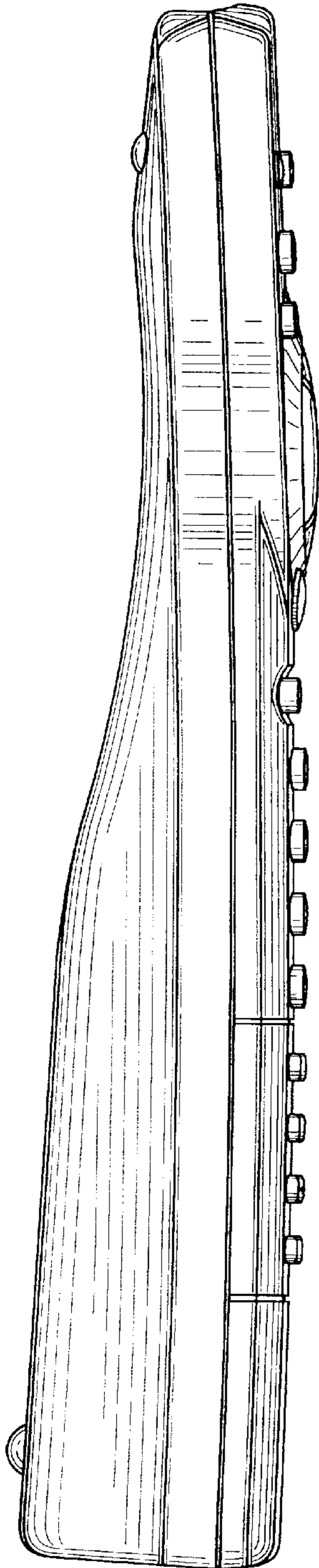

FIG. 6

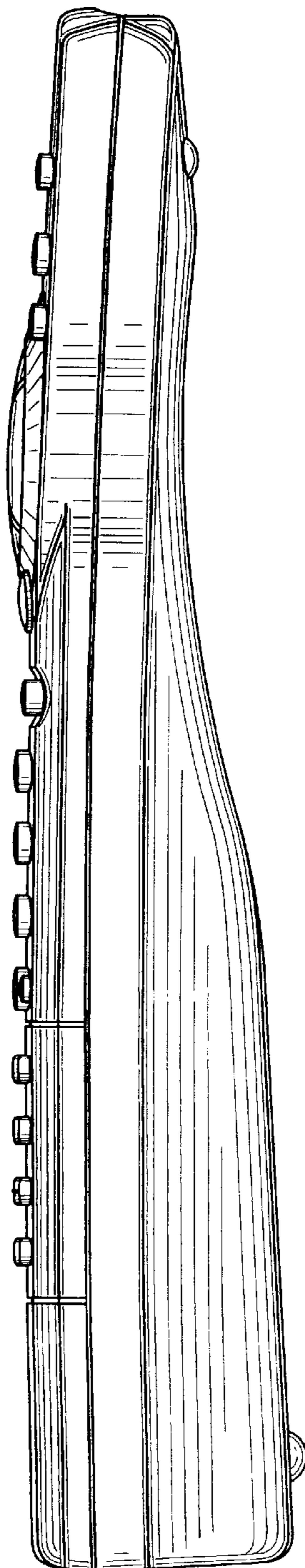

FIG. 7

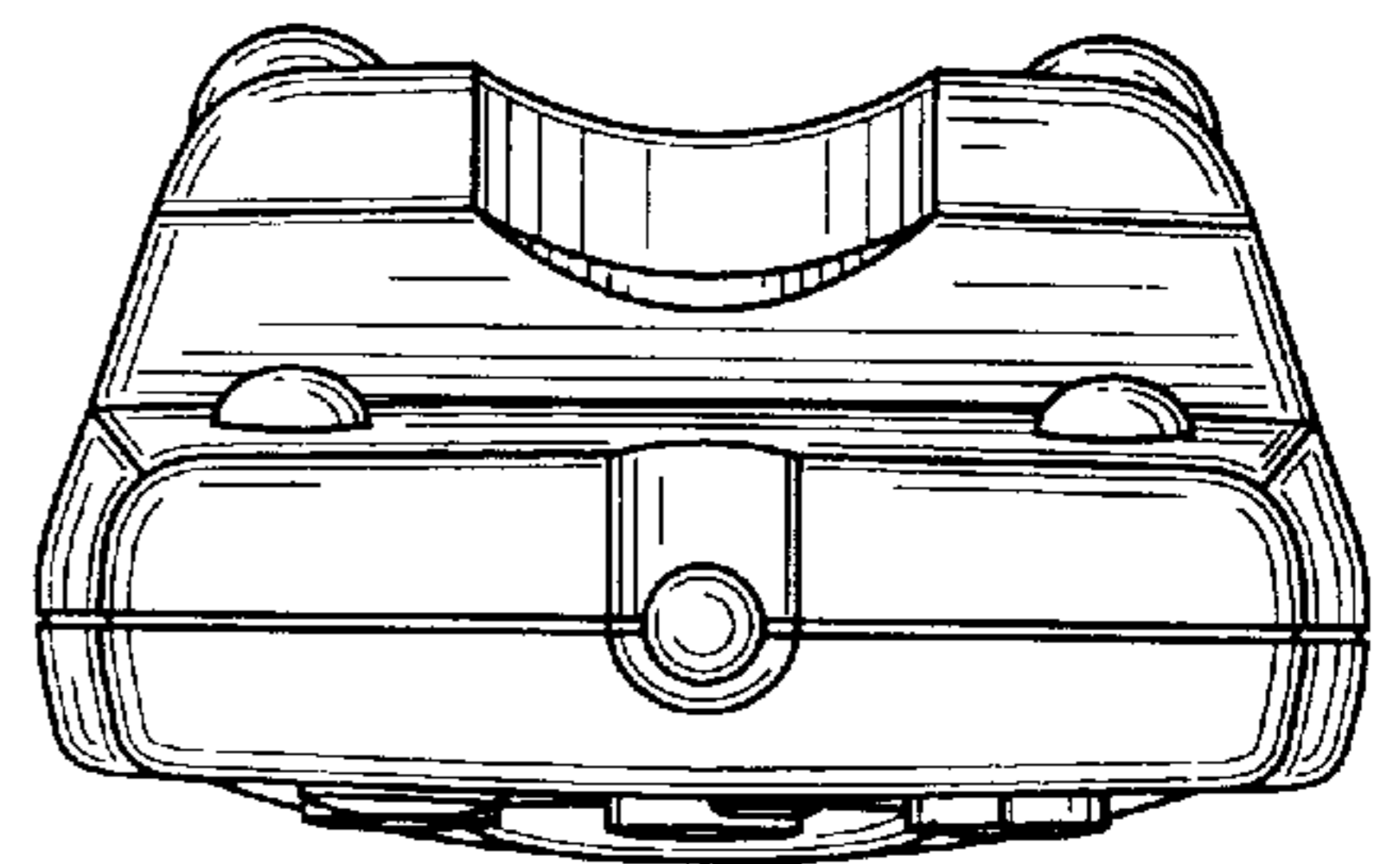

FIG. 8

