



US00D416906S

# United States Patent [19] Miyazaki

[11] **Patent Number: Des. 416,906**

[45] **Date of Patent: \*\* Nov. 23, 1999**

[54] **SPEAKER BOX**

4,805,729 2/1989 Wascom ..... 181/144

[75] Inventor: **Tetsuro Miyazaki**, Tokyo, Japan

### OTHER PUBLICATIONS

[73] Assignee: **Sony Corporation**, Tokyo, Japan

PC and Mac Connection, p. 127, MDS 40 Watt Speakers, model No. 18730, Jun. 1995.

[\*\*] Term: **14 Years**

Sony, "Catalog 89", p. 115, (Jul. 1998).

[21] Appl. No.: **29/092,577**

*Primary Examiner*—Nanda Bondade

*Attorney, Agent, or Firm*—Foley & Lardner

[22] Filed: **Aug. 24, 1998**

[57] **CLAIM**

[51] **LOC (6) Cl.** ..... **14-01**

The ornamental design for a speaker box, as shown and described.

[52] **U.S. Cl.** ..... **D14/214**

[58] **Field of Search** ..... D14/204, 209–216,  
D14/219; 181/144, 145, 147, 148, 150,  
153, 157, 198, 199; 381/24, 88, 90, 153,  
159, 186, 188

### DESCRIPTION

[56] **References Cited**

#### U.S. PATENT DOCUMENTS

D. 268,673	4/1983	Iijima	.....	D14/214
D. 317,008	5/1991	Emmerling	.....	D14/210 X
D. 342,255	12/1993	Ito et al.	.....	D14/211 X
D. 392,977	3/1998	Kim	.....	D14/214

FIG. 1 is a perspective view of a speaker box showing my new design;

FIG. 2 is a top plan view thereof;

FIG. 3 is a left side elevational view thereof;

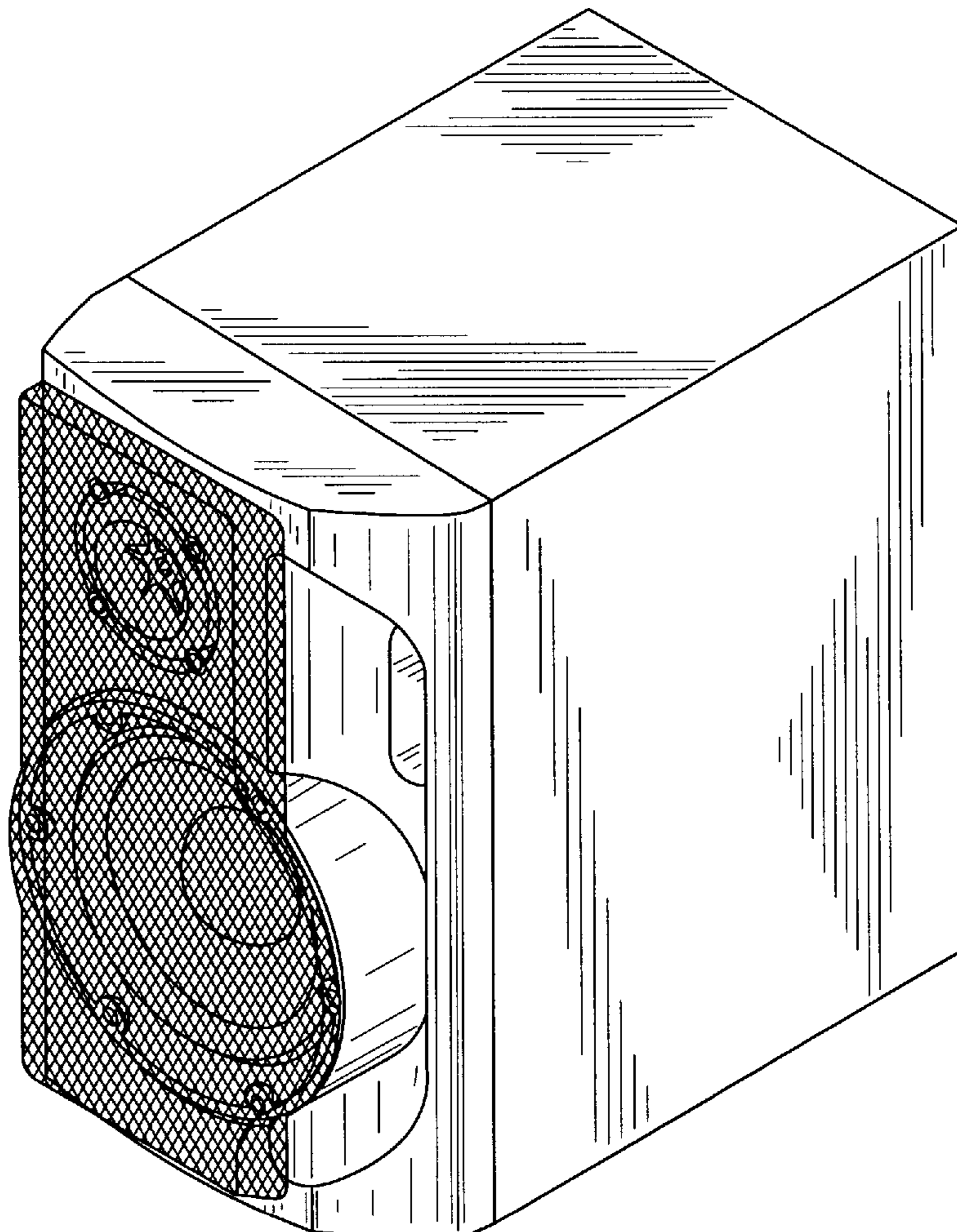
FIG. 4 is a front elevational view thereof;

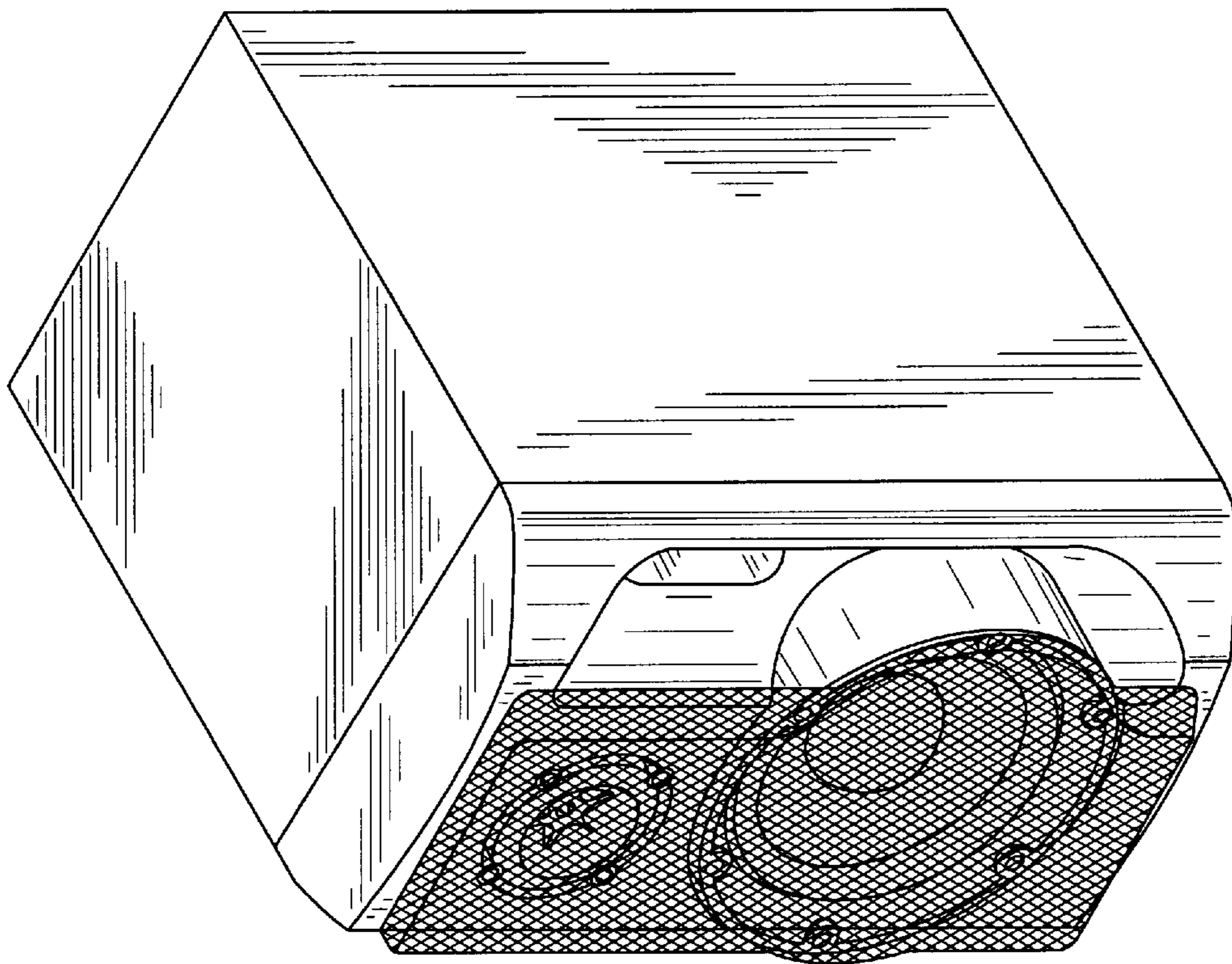
FIG. 5 is a right side elevational view thereof;

FIG. 6 is a rear elevational view thereof; and,

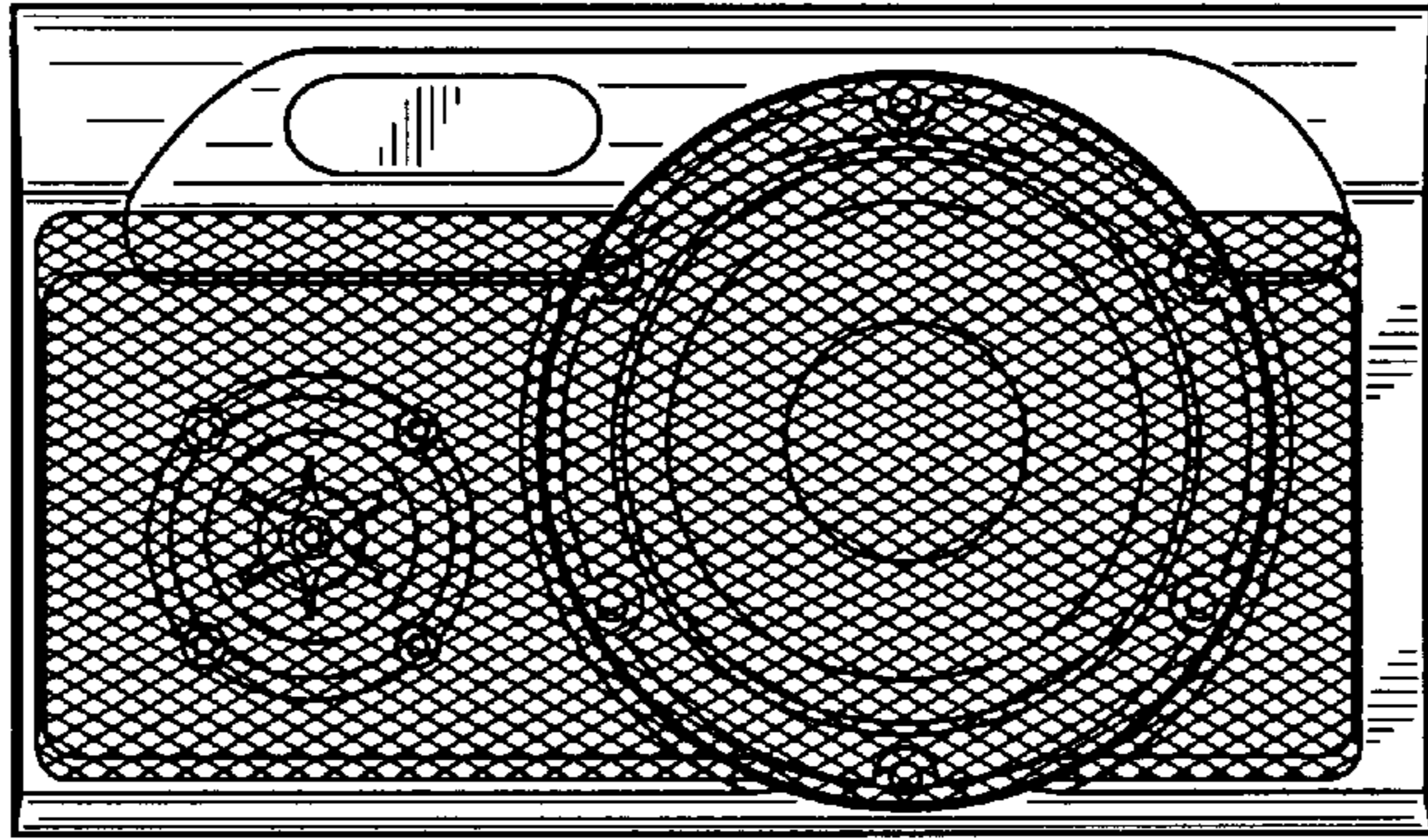
FIG. 7 is a bottom plan view thereof.

**1 Claim, 3 Drawing Sheets**

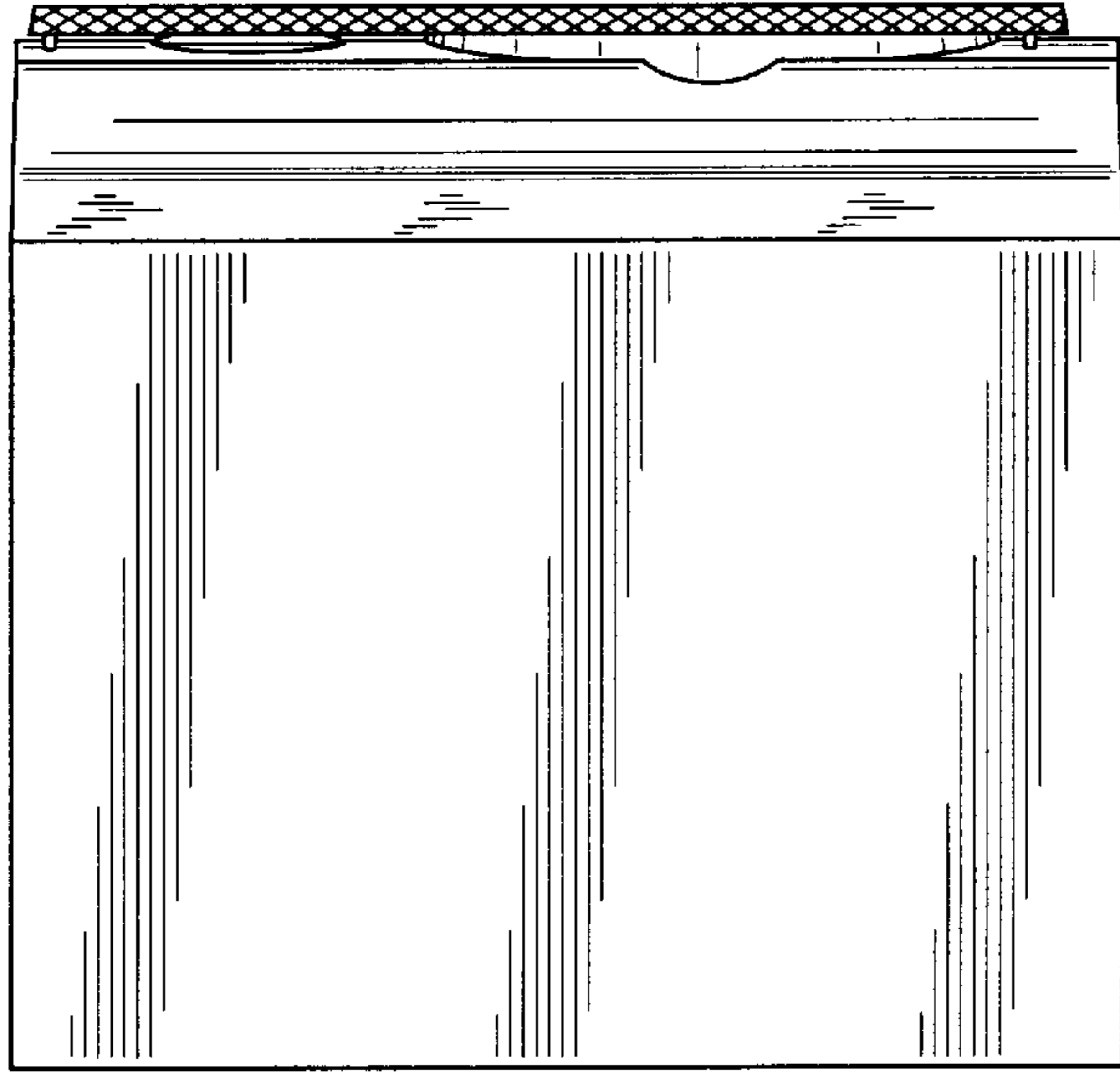




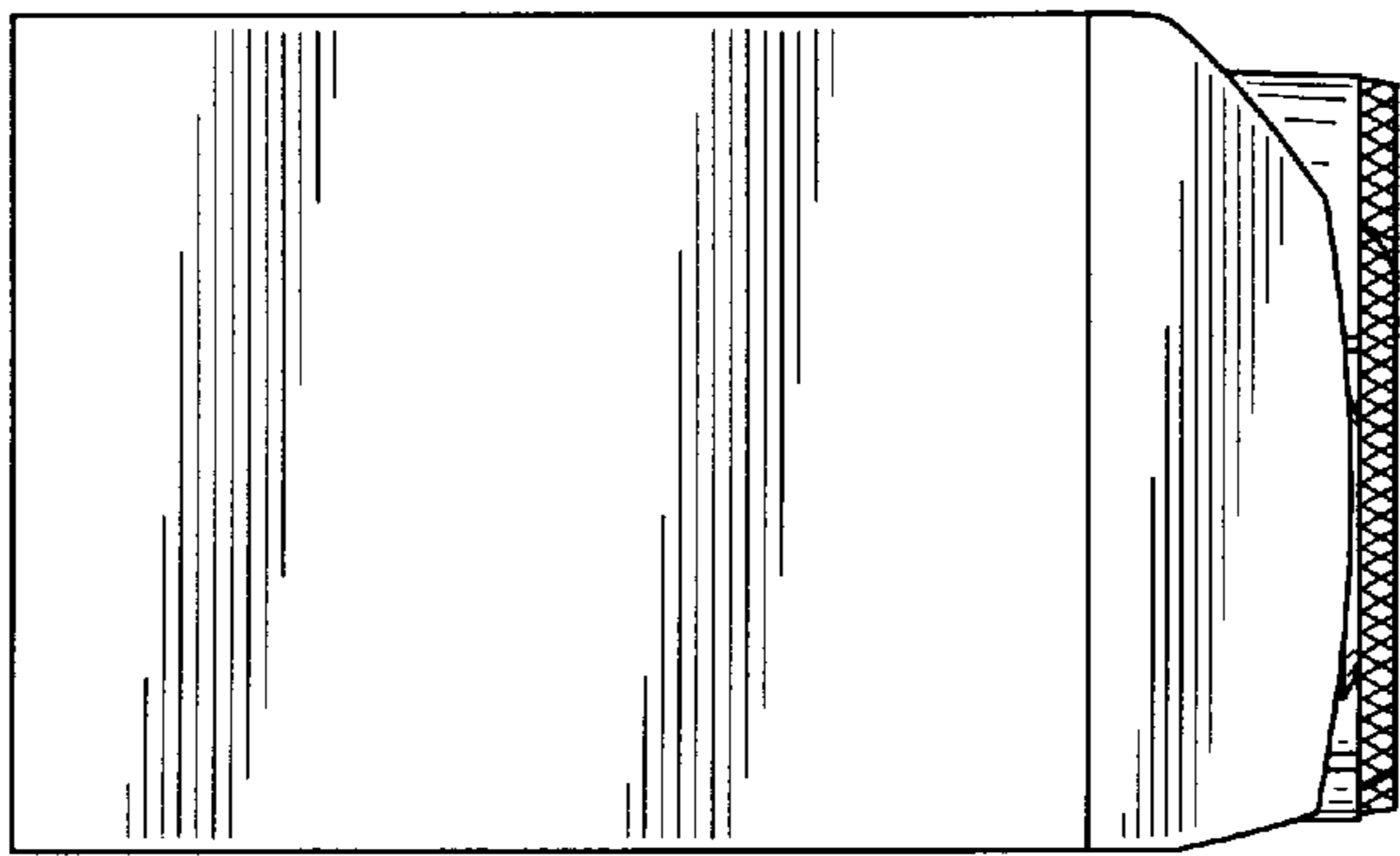
**FIG. 1**



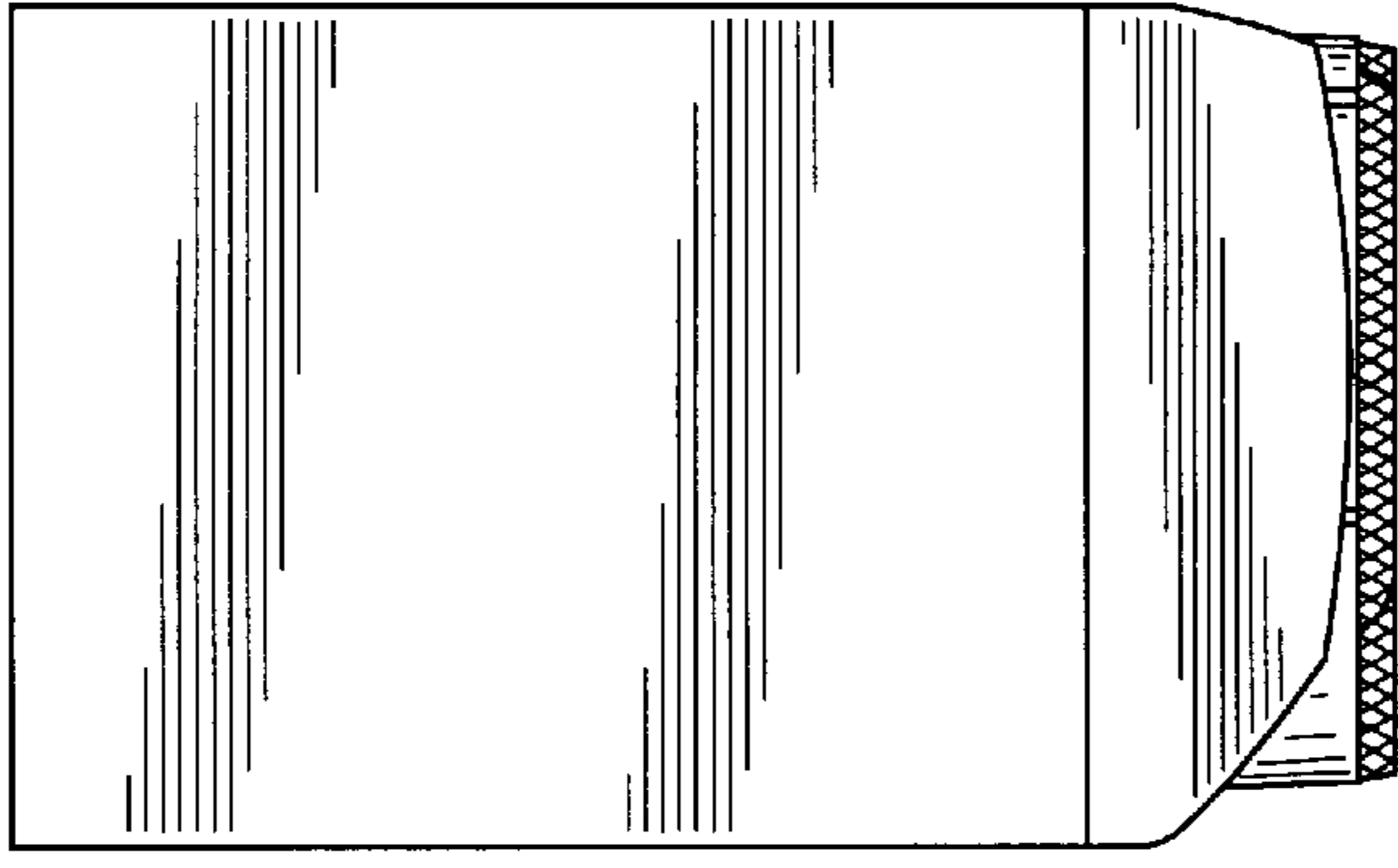
**FIG. 4**



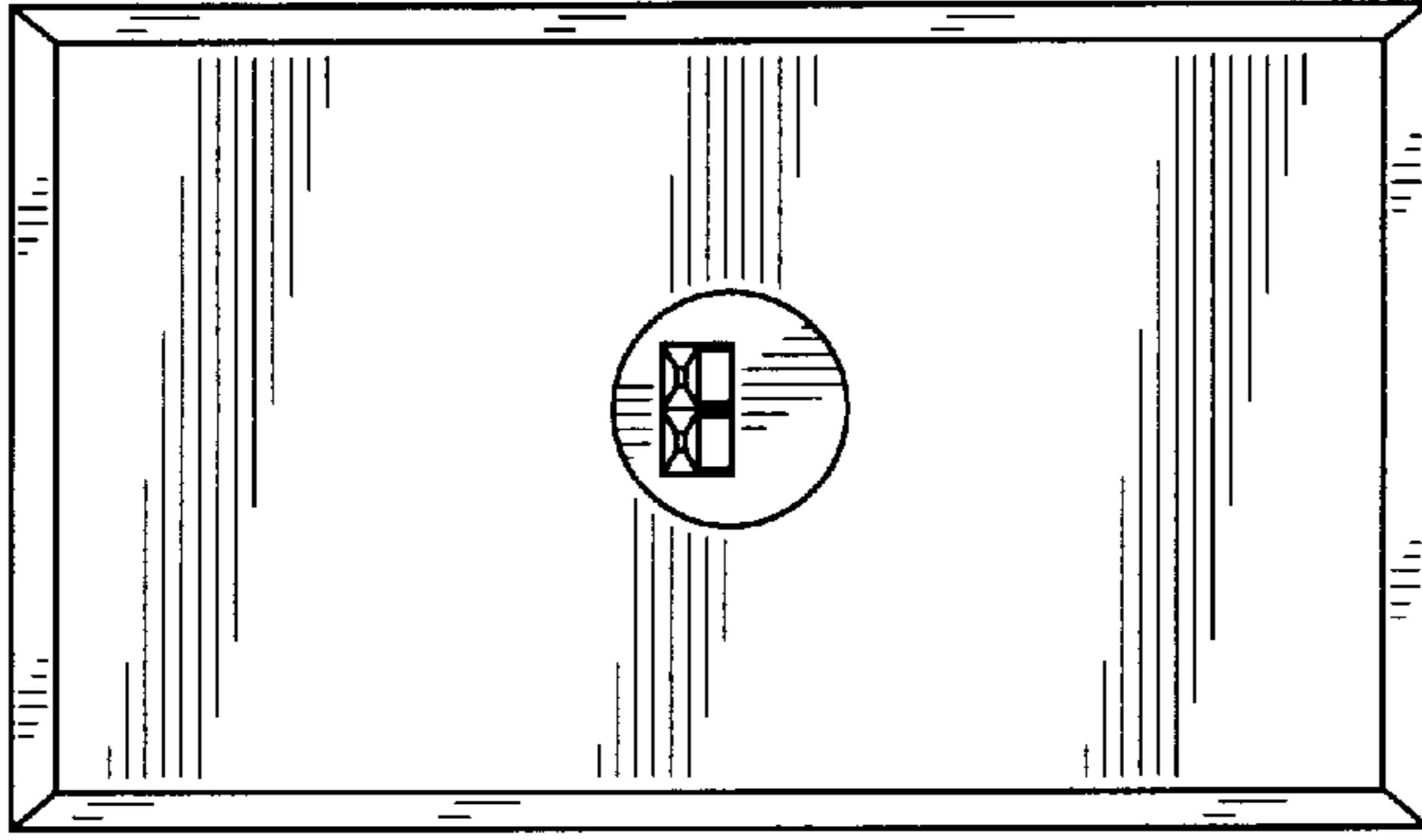
**FIG. 3**



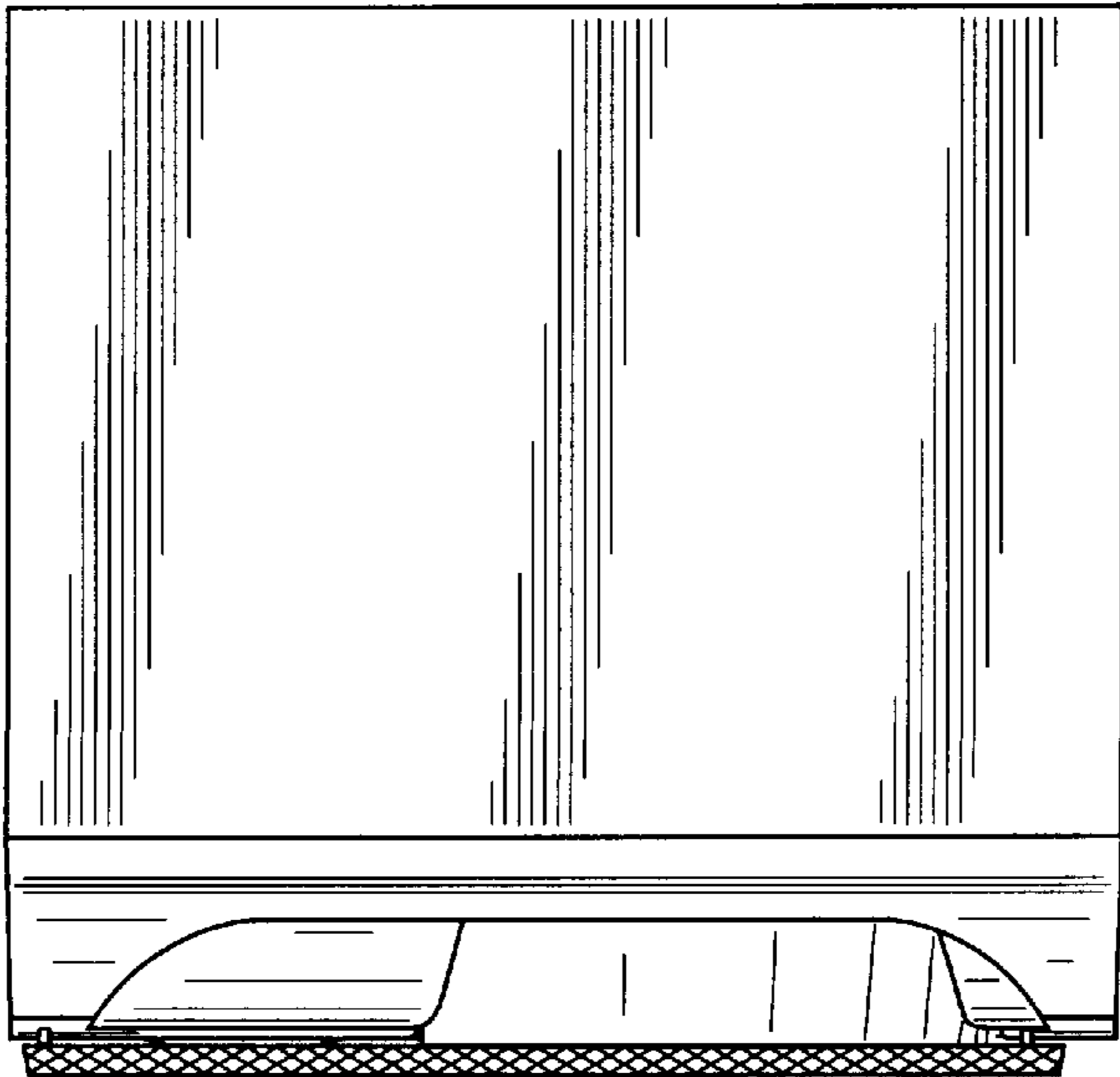
**FIG. 2**



**FIG. 7**



**FIG. 6**



**FIG. 5**