



US00D416806S

United States Patent [19]
Zimmer et al.

[11] **Patent Number: Des. 416,806**
[45] **Date of Patent: ** Nov. 23, 1999**

[54] **CONTAINER**

[75] Inventors: **Gregory Alan Zimmer**, Cincinnati, Ohio; **Glenn Ilustre de Guzman**, Kobe; **Ryoichi Tomishima**, Hyogo, both of Japan

[73] Assignee: **The Procter & Gamble Company**, Cincinnati, Ohio

[**] Term: **14 Years**

[21] Appl. No.: **29/084,659**

[22] Filed: **Mar. 6, 1998**

[51] **LOC (6) Cl.** **09-01**

[52] **U.S. Cl.** **D9/552**

[58] **Field of Search** D9/552, 556, 500, D9/516; 215/382-384

[56] **References Cited**

U.S. PATENT DOCUMENTS

D. 398,855 9/1998 Ito D9/537
D. 406,765 3/1999 Zimmer et al. D9/523

FOREIGN PATENT DOCUMENTS

648625 4/1985 Japan .
658456 8/1985 Japan .
671267 2/1986 Japan .
862853 3/1993 Japan .

Primary Examiner—Dominic Simone

Attorney, Agent, or Firm—Elizabeth M. Koch; James C. Vago

[57] **CLAIM**

The ornamental design for a container, as shown and described.

DESCRIPTION

FIG. 1 is a perspective view of a container embodying our new design;

FIG. 2 is a front side elevational view thereof, the rear side elevational view being a mirror-image;

FIG. 3 is a top plan view thereof;

FIG. 4 is a bottom plan view thereof;

FIG. 5 is a right side elevational view thereof;

FIG. 6 is a left side elevational view thereof;

FIG. 7 is a cross-sectional view taken on the line I—I of FIG. 2.

FIG. 8 is a perspective view of the container;

FIG. 9 is a front side elevational view thereof; the rear side elevational view being a mirror-image;

FIG. 10 is a top plan view thereof;

FIG. 11 is a bottom plan view thereof;

FIG. 12 is a right side elevational view thereof;

FIG. 13 is a left side elevational view thereof; and,

FIG. 14 is a cross-sectional view taken on the line II-II of FIG. 9.

The broken line showing of a sprayer head is for illustrative purpose only and forms no part of the claimed design.

1 Claim, 14 Drawing Sheets

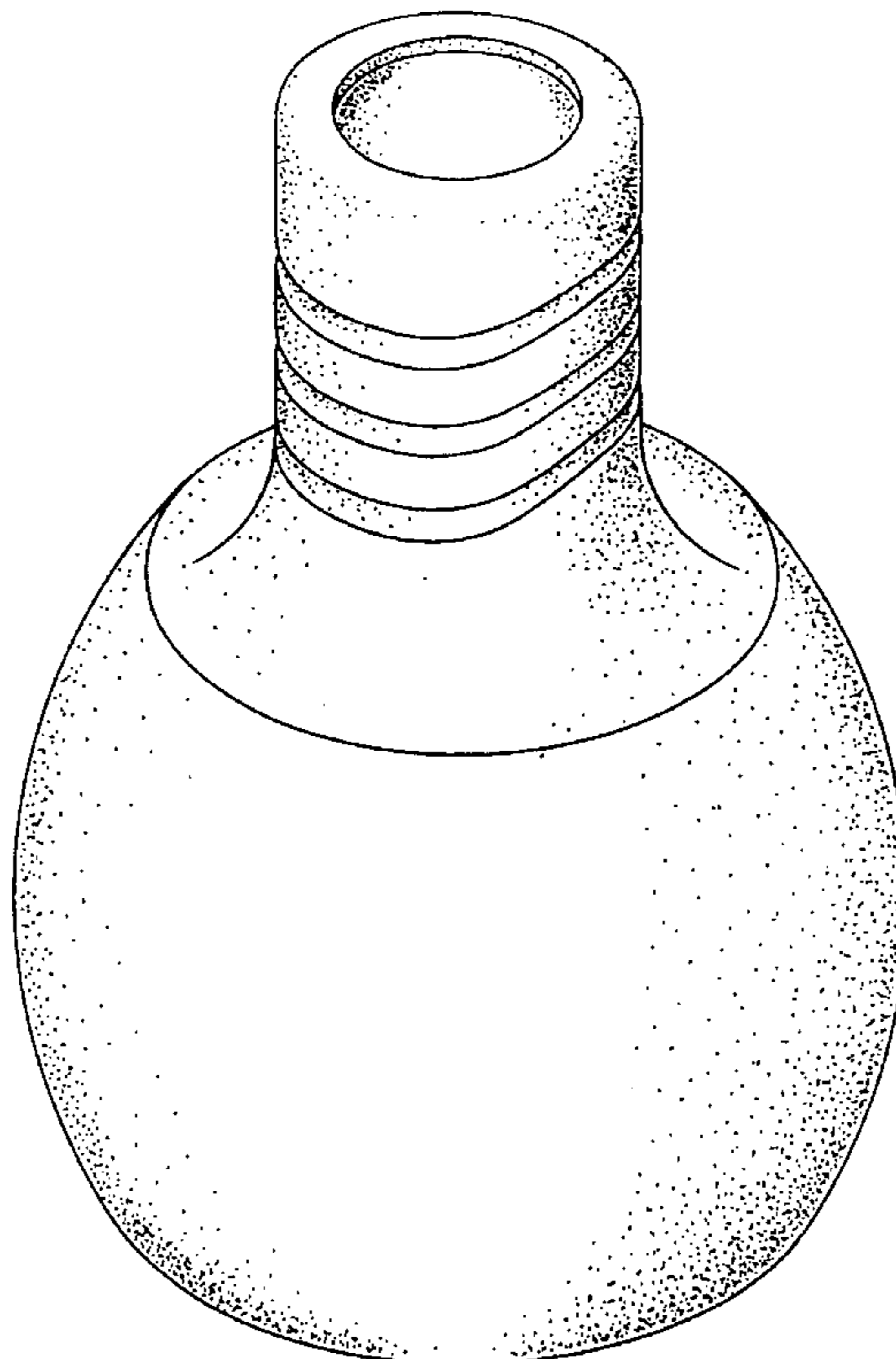

FIG. 1

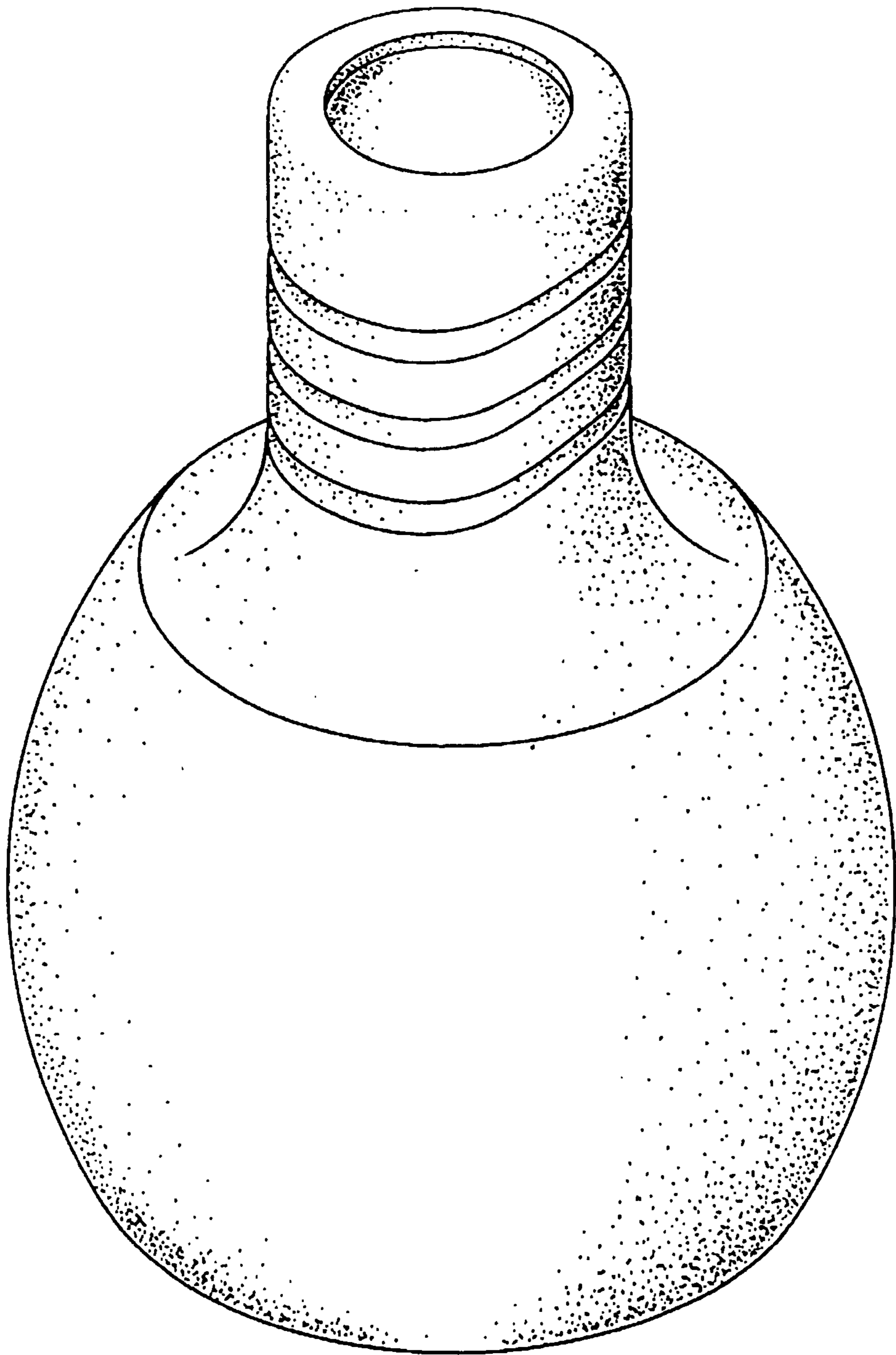

FIG. 2

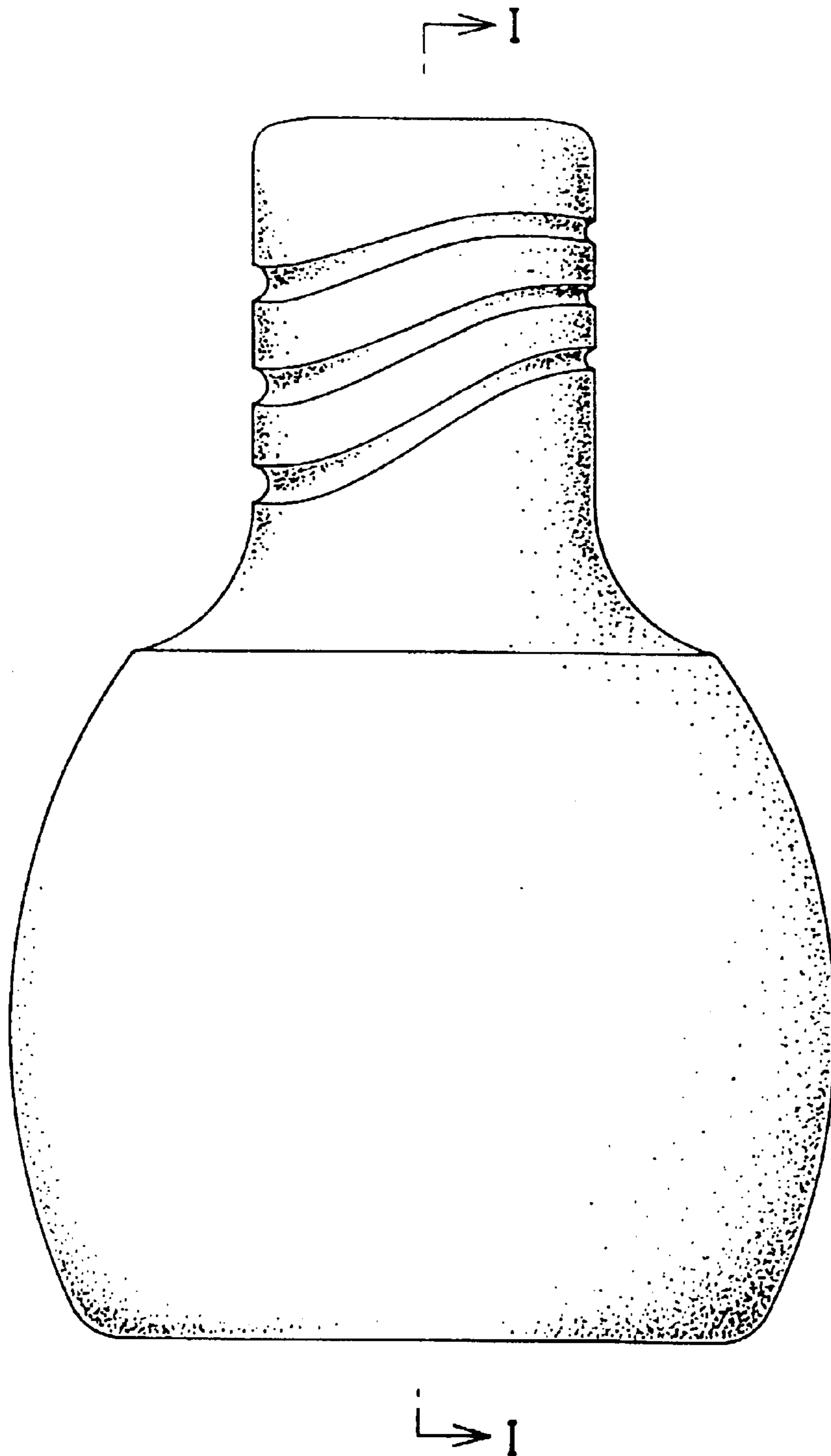

FIG. 3

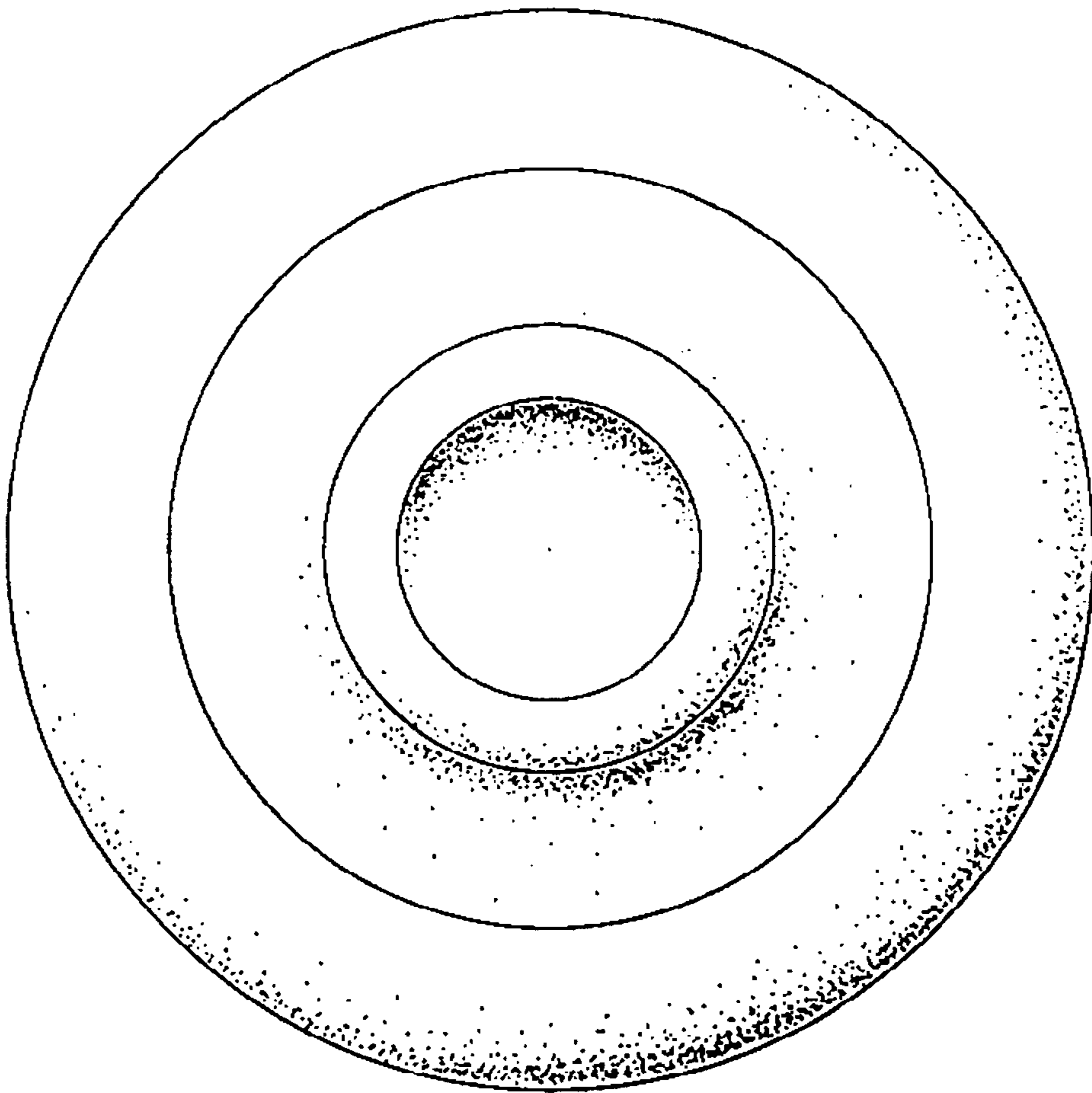

FIG. 4

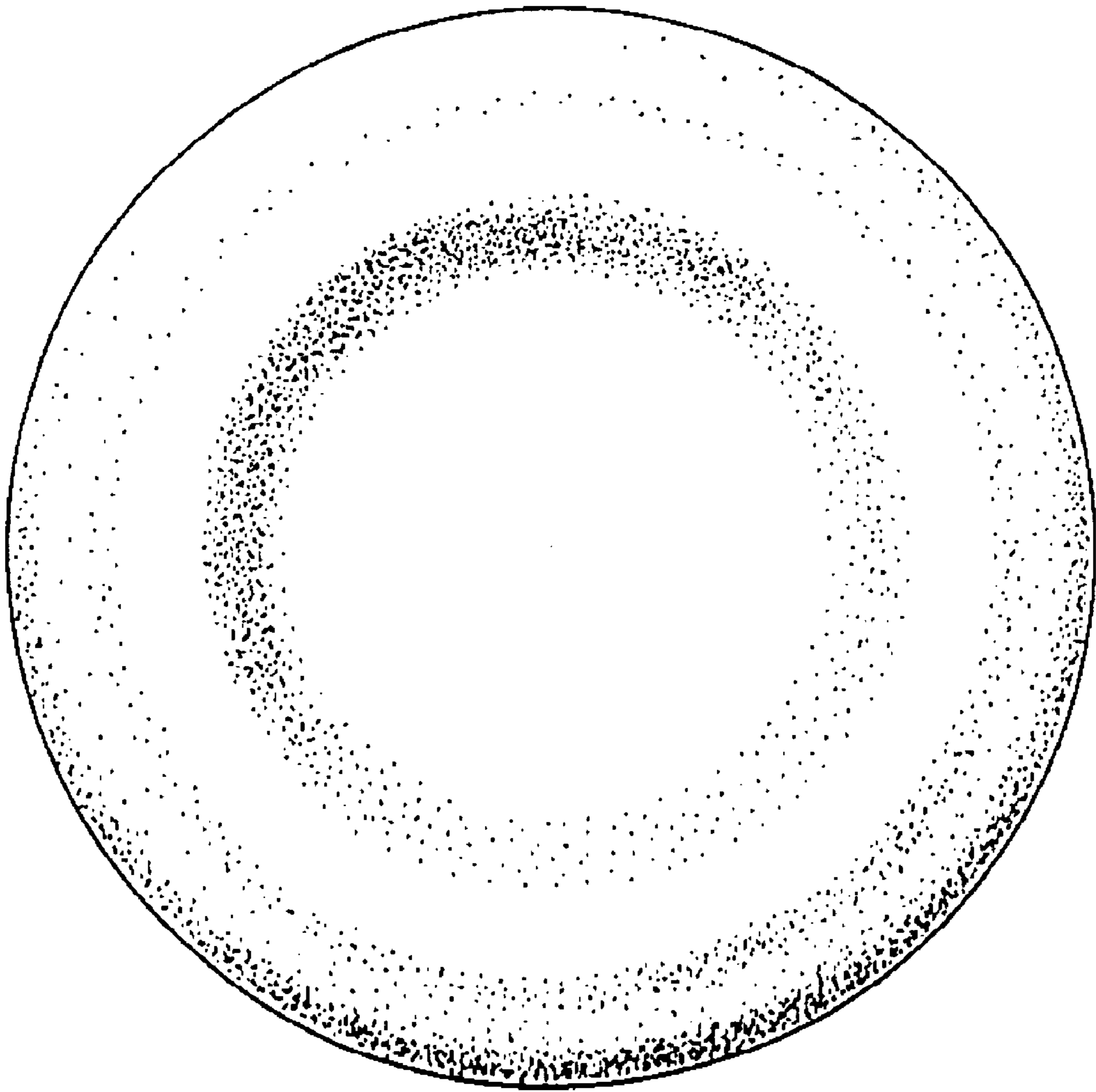

FIG. 5

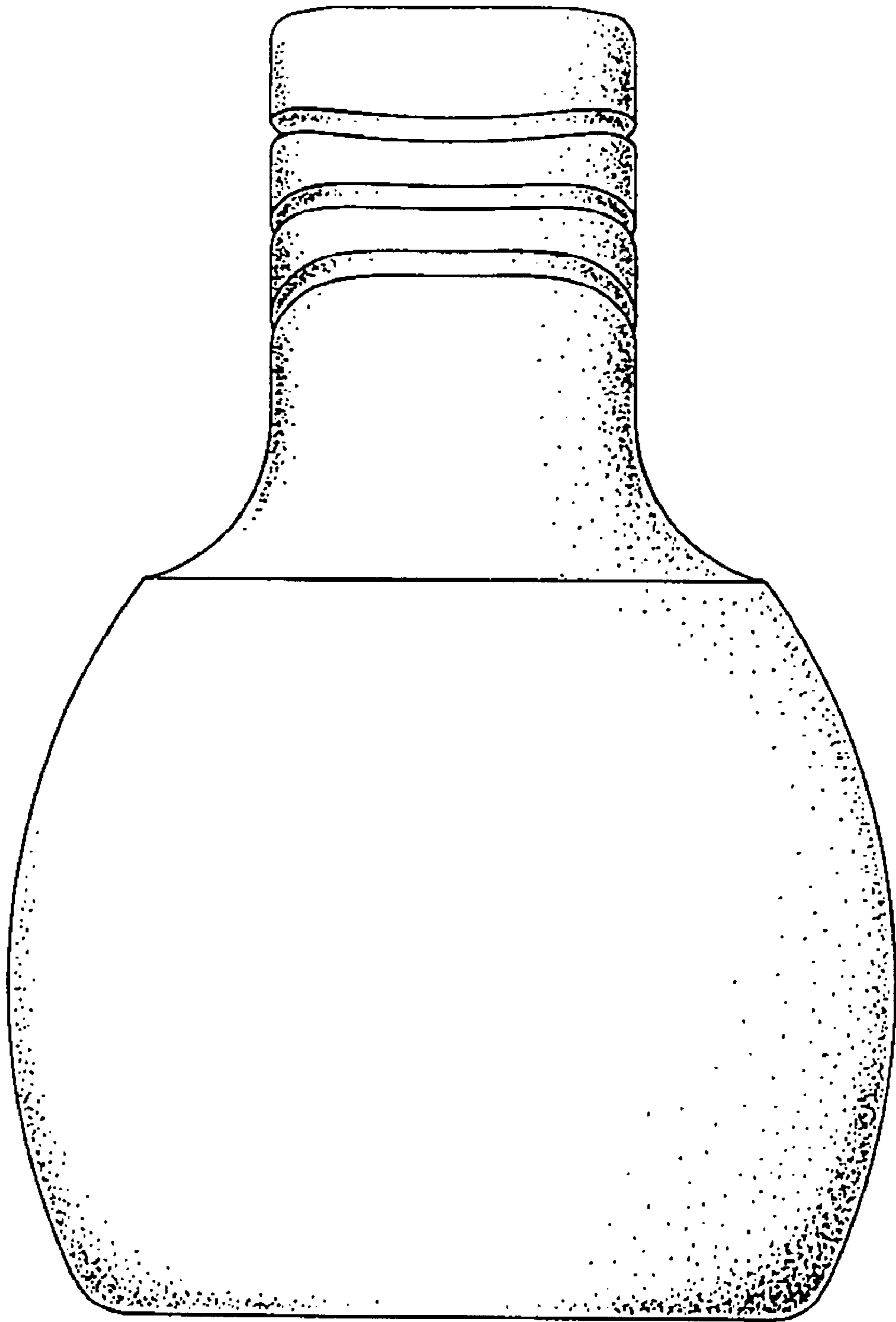

FIG. 6

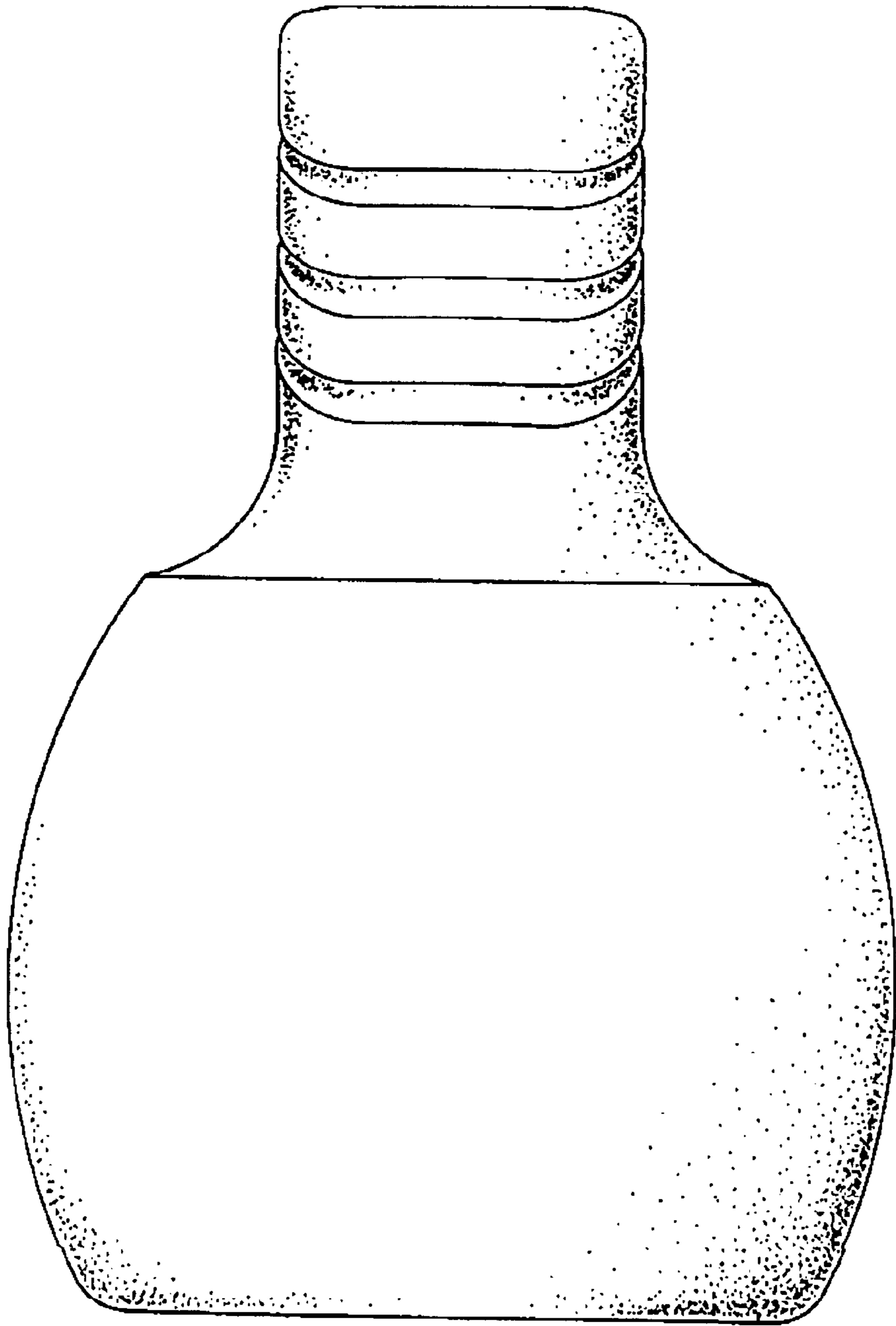

FIG. 7

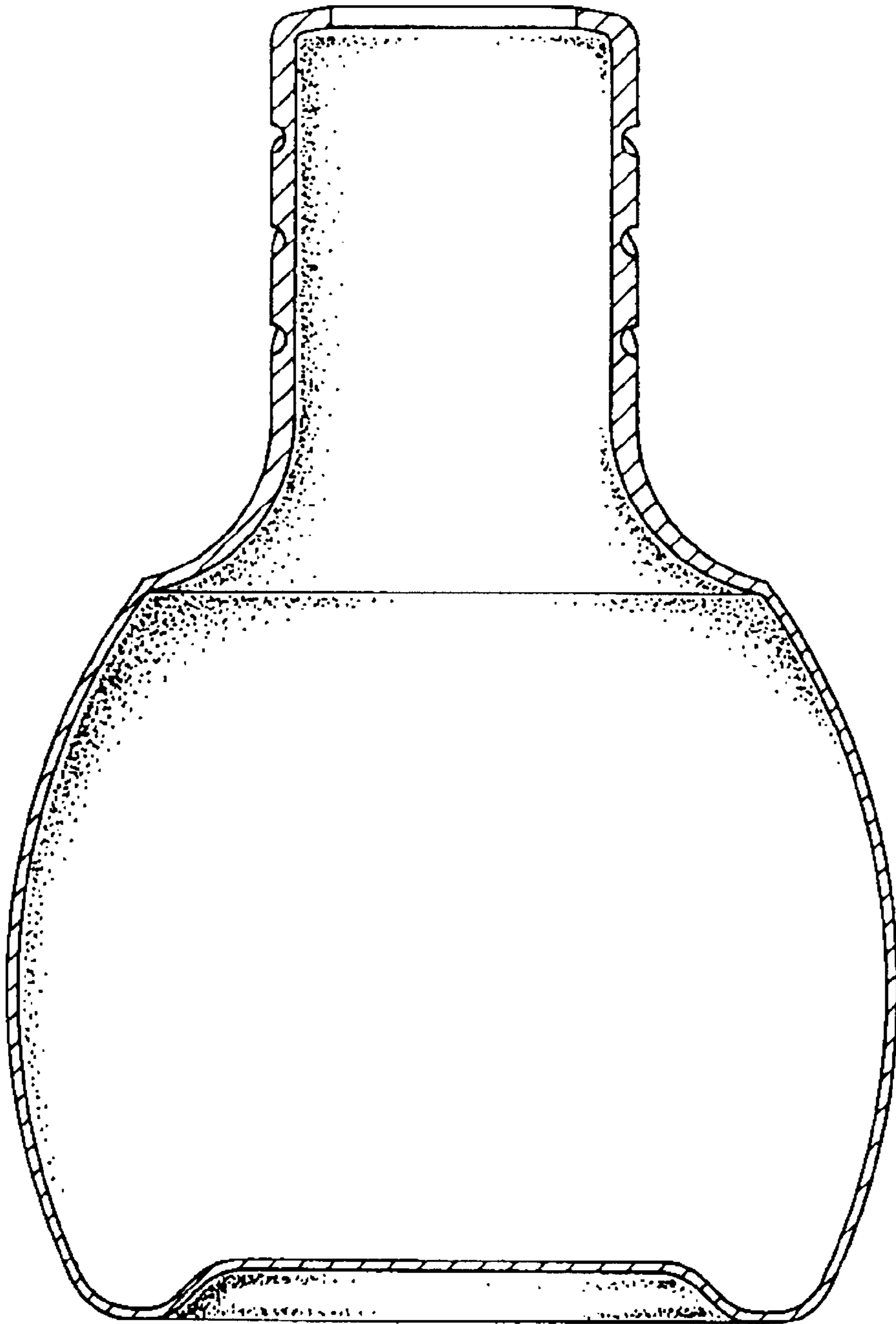

FIG. 8

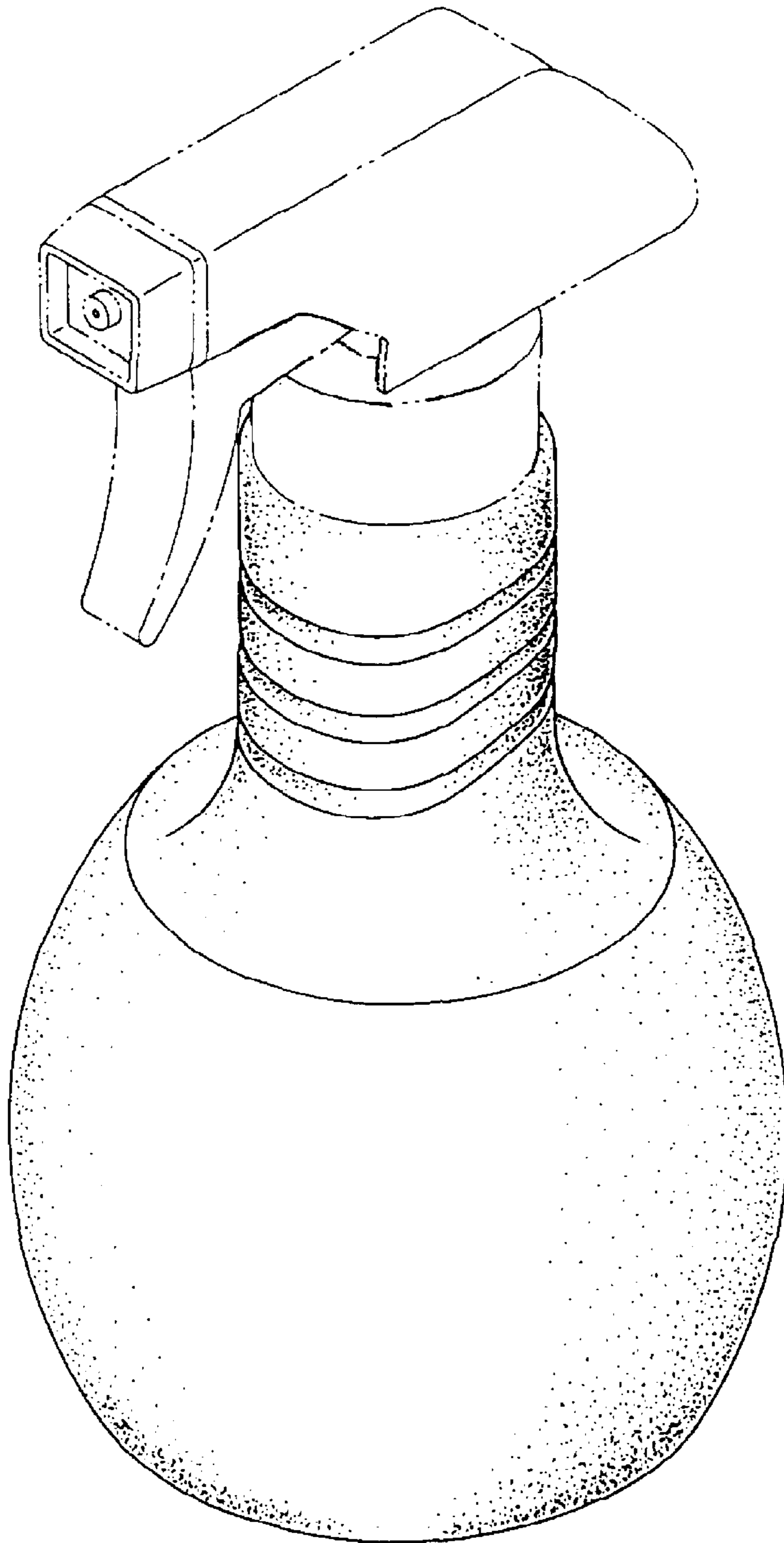

FIG. 9



FIG. 10

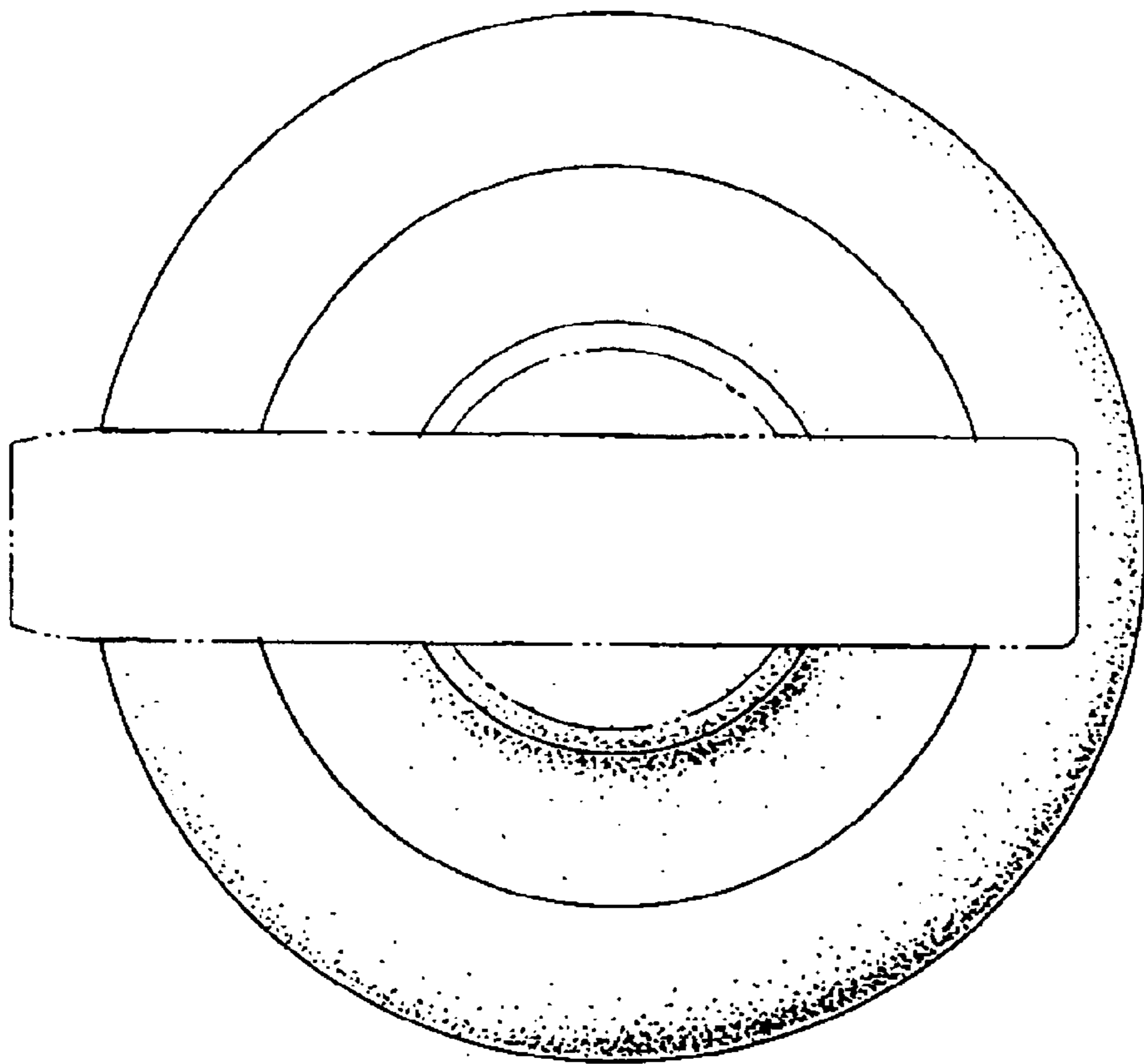

FIG. 11

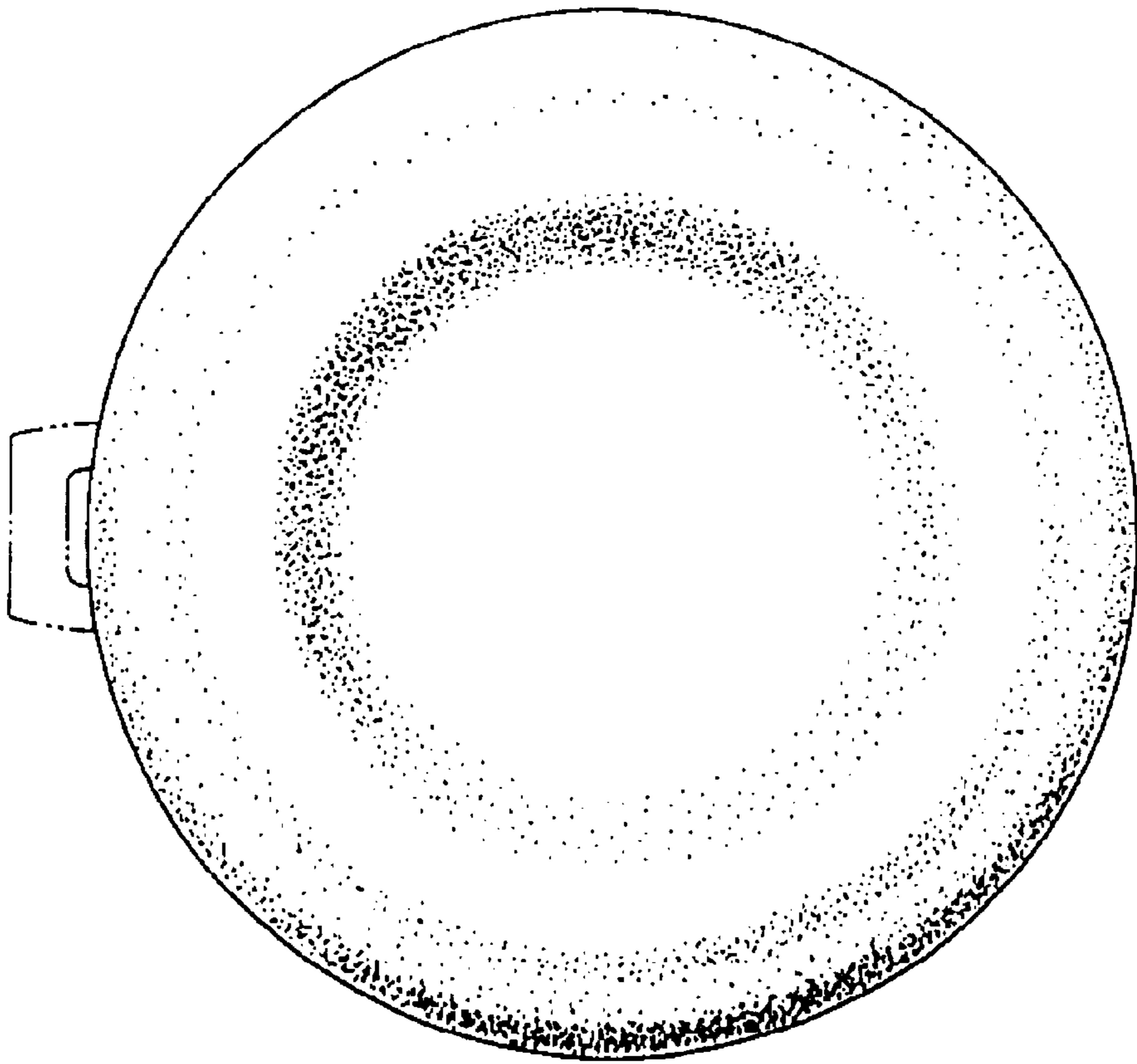

FIG. 12



FIG. 13

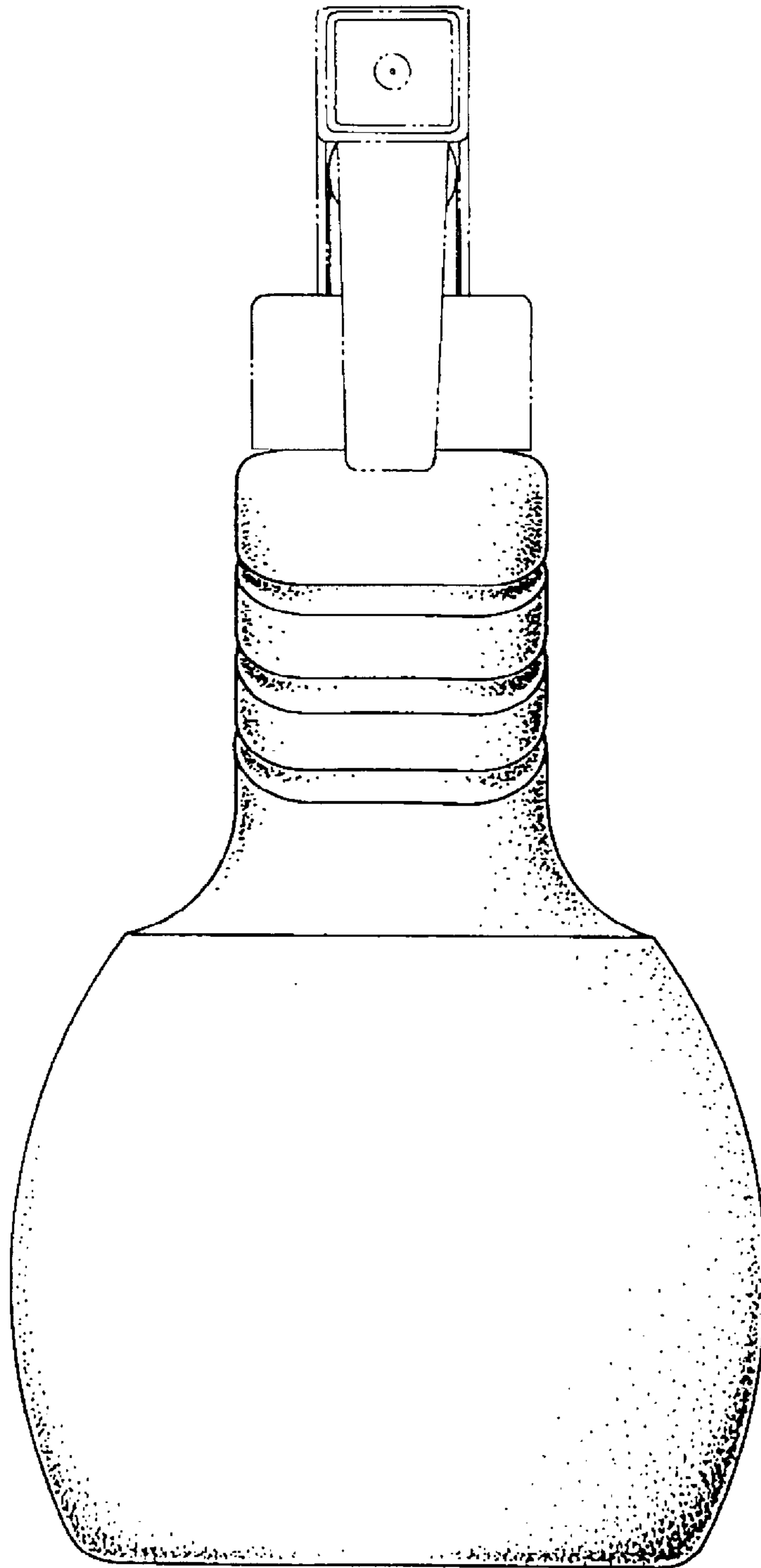

FIG. 14

