



US00D416765S

United States Patent [19]

Dankwardt et al.

[11] Patent Number: Des. 416,765

[45] Date of Patent: ** Nov. 23, 1999

[54] HOLDER FOR BEVERAGE CONTAINER

5,664,718 9/1997 Vine .
5,906,348 5/1999 Orenstein 248/311.2

[75] Inventors: **Kevin P. Dankwardt**, 196 Escuela Ave., Mt. View, Calif. 94040; **Kenneth Burgess**, Sunnyvale, Calif.

Primary Examiner—Terry A. Wallace
Attorney, Agent, or Firm—Blakely, Sokoloff, Taylor & Zafman LLP

[73] Assignee: **Kevin P. Dankwardt**, Mt. View, Calif.

[57] CLAIM

[**] Term: **14 Years**

The ornamental design for a holder for beverage container, as shown and described.

[21] Appl. No.: **29/100,977**

[22] Filed: **Feb. 22, 1999**

[51] **LOC (6) Cl.** **07-06**

[52] **U.S. Cl.** **D7/620; D7/628**

[58] **Field of Search** D7/619-625, 628; D21/576, 598; 220/737, 906, 907; 248/311.2

DESCRIPTION

[56] References Cited

U.S. PATENT DOCUMENTS

D. 315,753	3/1991	Stephensen et al.	D21/598
2,594,896	4/1952	Feldman	215/395 X
5,529,202	6/1996	Shamis .	
5,533,697	7/1996	Fletcher et al. .	
5,533,700	7/1996	Porter .	
5,540,409	7/1996	Cunningham .	
5,551,592	9/1996	Barton et al. .	
5,570,863	11/1996	Cooper .	
5,586,804	12/1996	Burroughs .	
5,590,808	1/1997	Schaepi .	
5,597,148	1/1997	Gospodarich .	
5,597,190	1/1997	DeMars .	
5,601,268	2/1997	Dunchock .	
5,603,477	2/1997	Deutsch .	
5,609,318	3/1997	Sch eh .	
5,620,724	4/1997	Adler .	
5,628,485	5/1997	Ray .	
5,628,486	5/1997	Rossman et al. .	
5,634,621	6/1997	Jankovic .	
5,645,196	7/1997	Hancuff .	
5,647,519	7/1997	Brennan .	
5,655,742	8/1997	Whitman et al. .	
5,657,897	8/1997	Schwartzburg .	
5,664,671	9/1997	Nedblake, Jr. .	

FIG. 1 is a front, right side perspective view of our holder for a beverage container according to a first embodiment; FIG. 2 is a right side elevation view of the holder for a beverage container according to the first embodiment, the left side being a mirror image of the right side; FIG. 3 is a front elevation view of the holder for a beverage container according to the first embodiment; FIG. 4 is a back elevation view of the holder for a beverage container according to the first embodiment; FIG. 5 is a bottom plan view of the holder for a beverage container according to the first embodiment; FIG. 6 is a top plan view of the holder for a beverage container according to the first embodiment; FIG. 7 is a front, right side perspective view of our holder for a beverage container according to a second embodiment; FIG. 8 is a right side elevation view of the holder for a beverage container according to the second embodiment, the left side being a mirror image of the right side; FIG. 9 is a front elevation view of the holder for a beverage container according to the second embodiment; FIG. 10 is a back elevation view of the holder for a beverage container according to the second embodiment; FIG. 11 is a bottom plan view of the holder for a beverage container according to the second embodiment; and, FIG. 12 is a top plan view of the holder for a beverage container according to the second embodiment.

The broken lines are for illustrative purposes only and form no part of the claimed design.

1 Claim, 12 Drawing Sheets

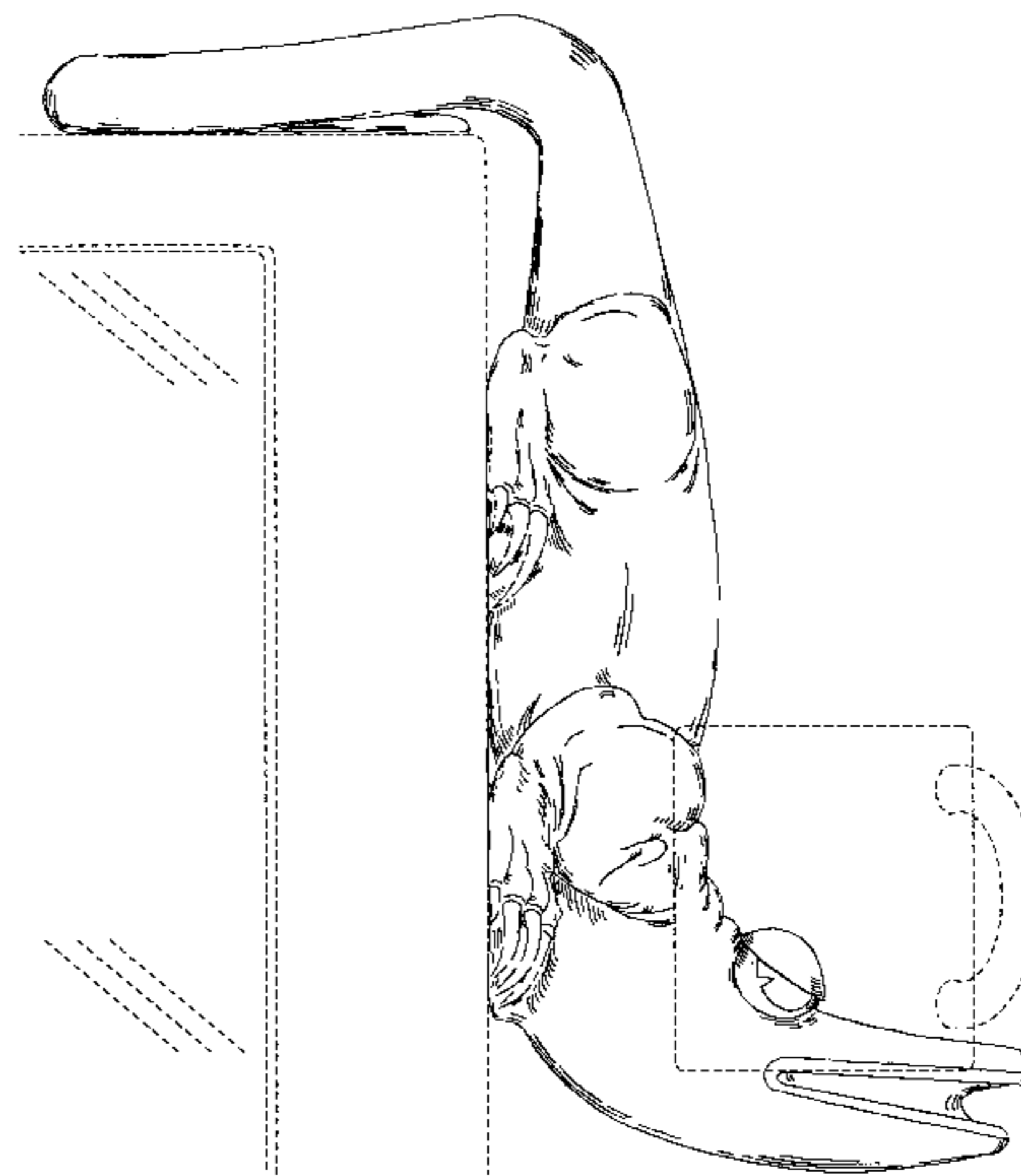
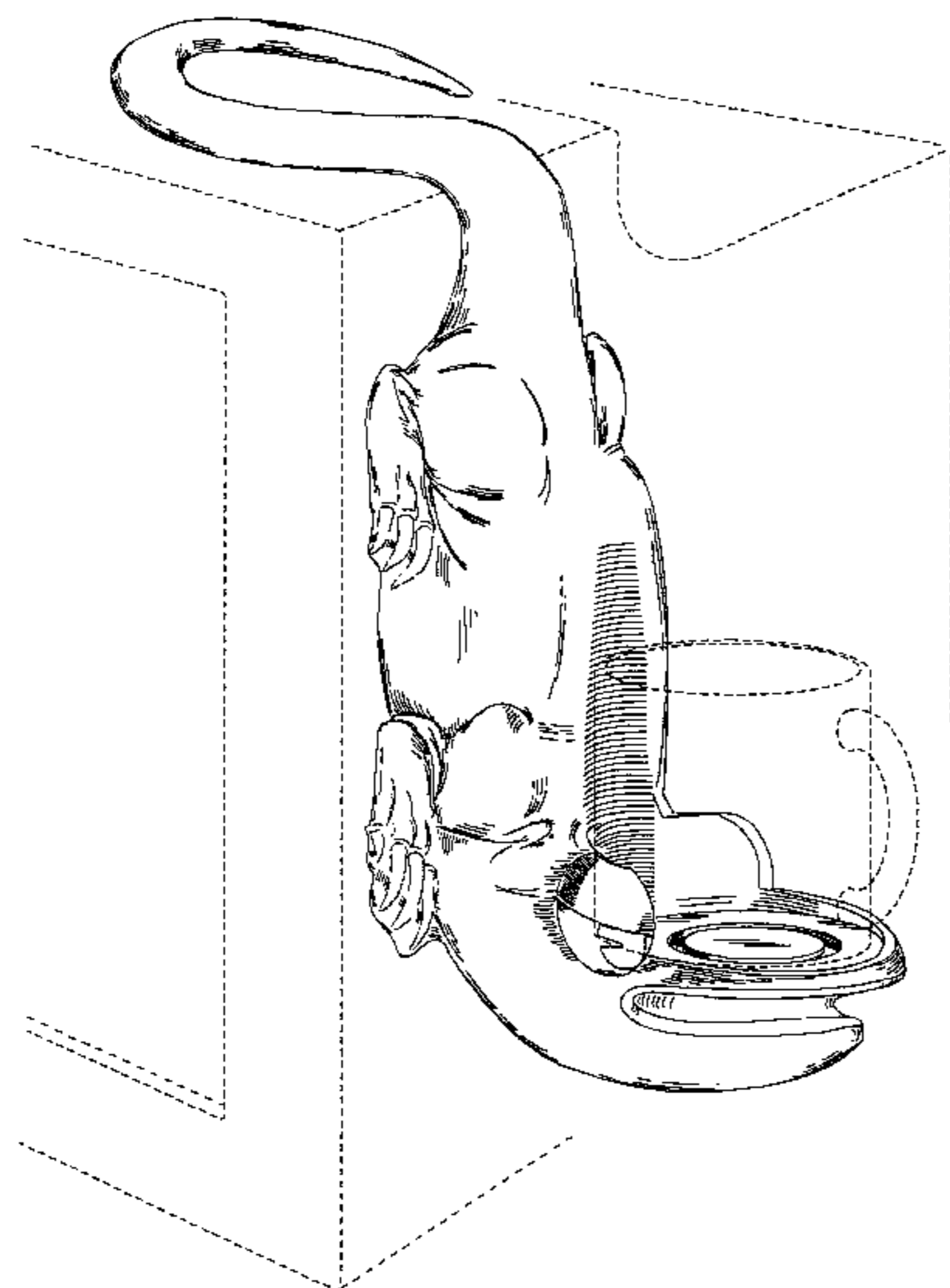

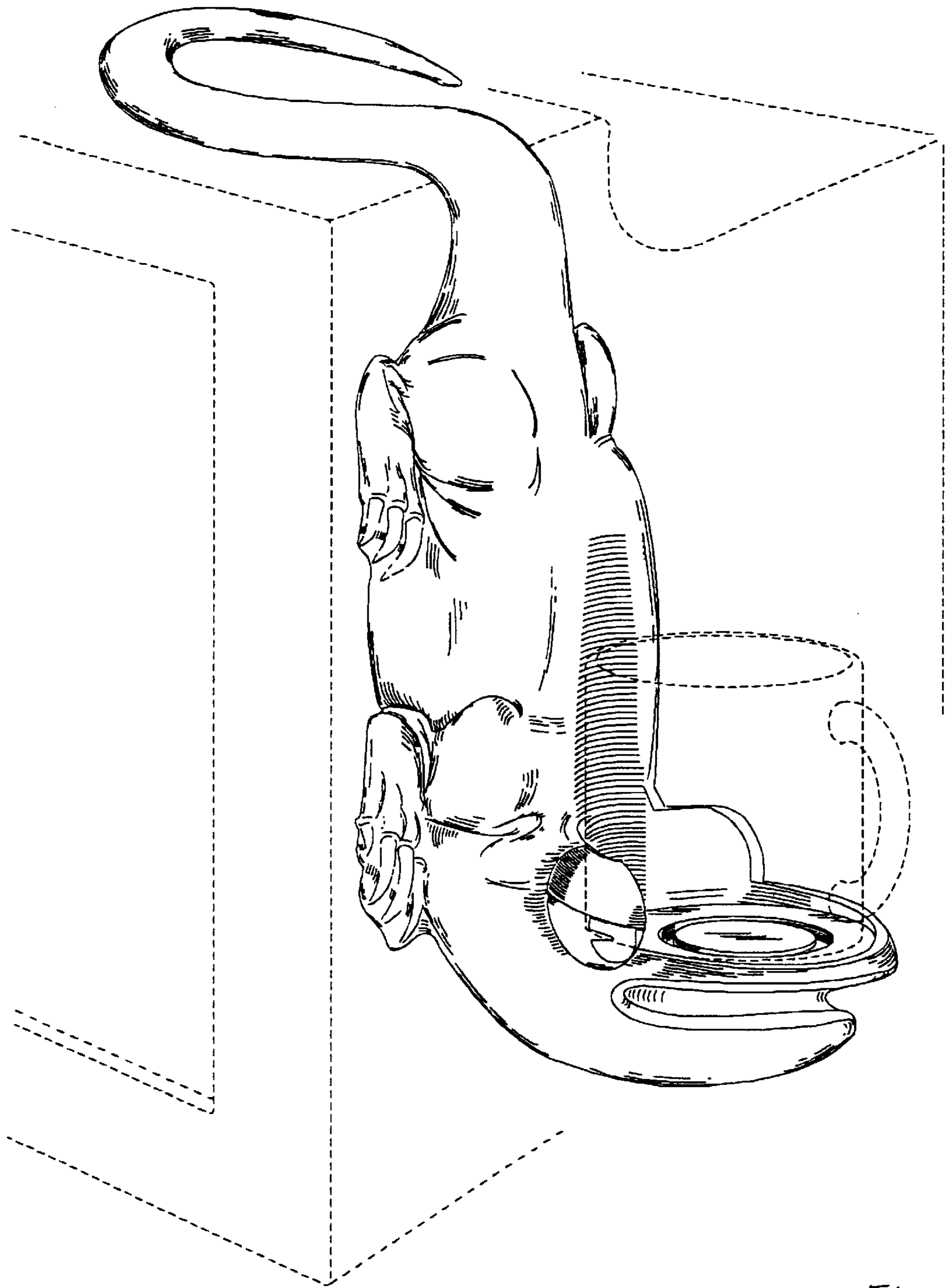

Fig. 1

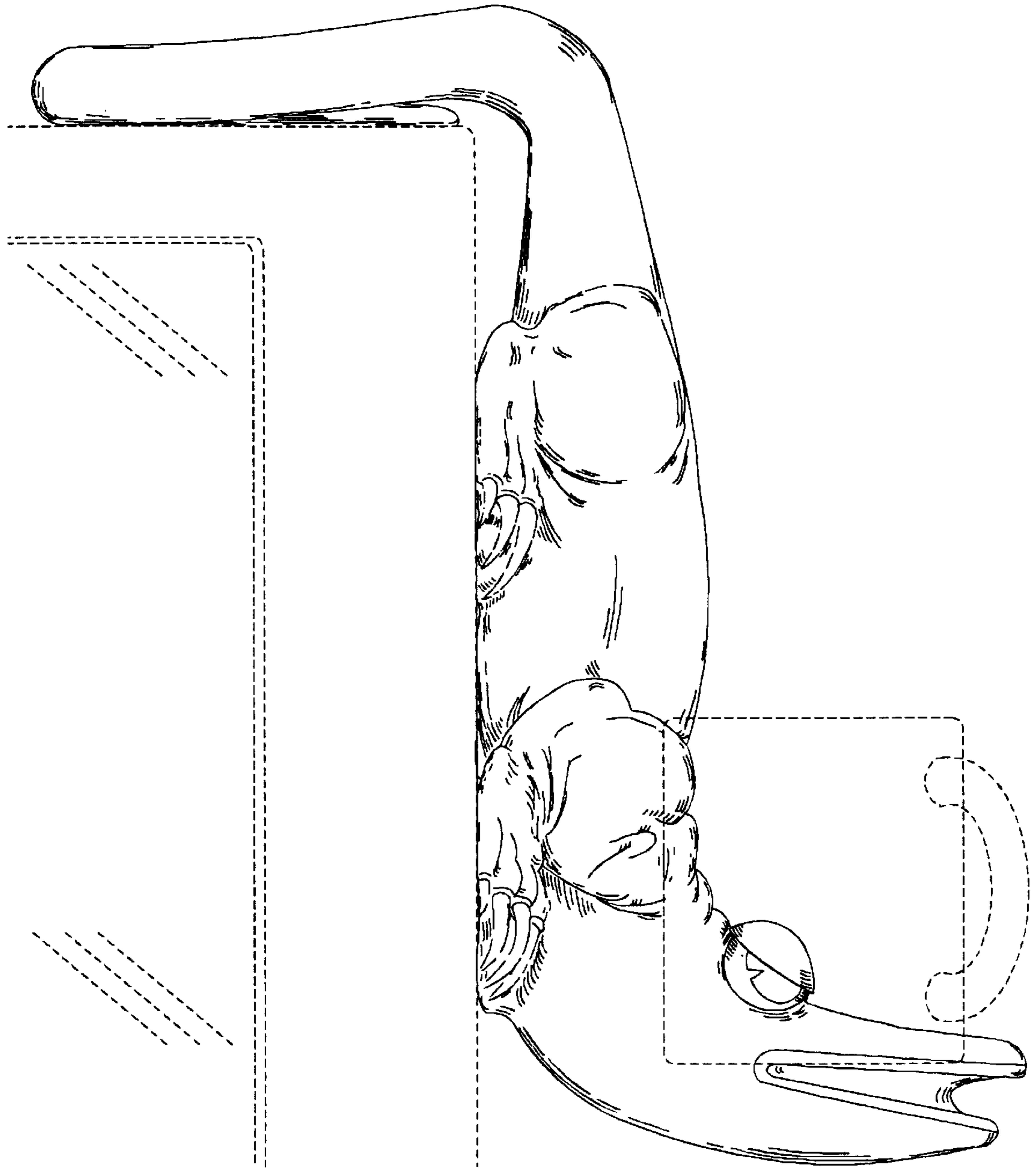

Fig. 2

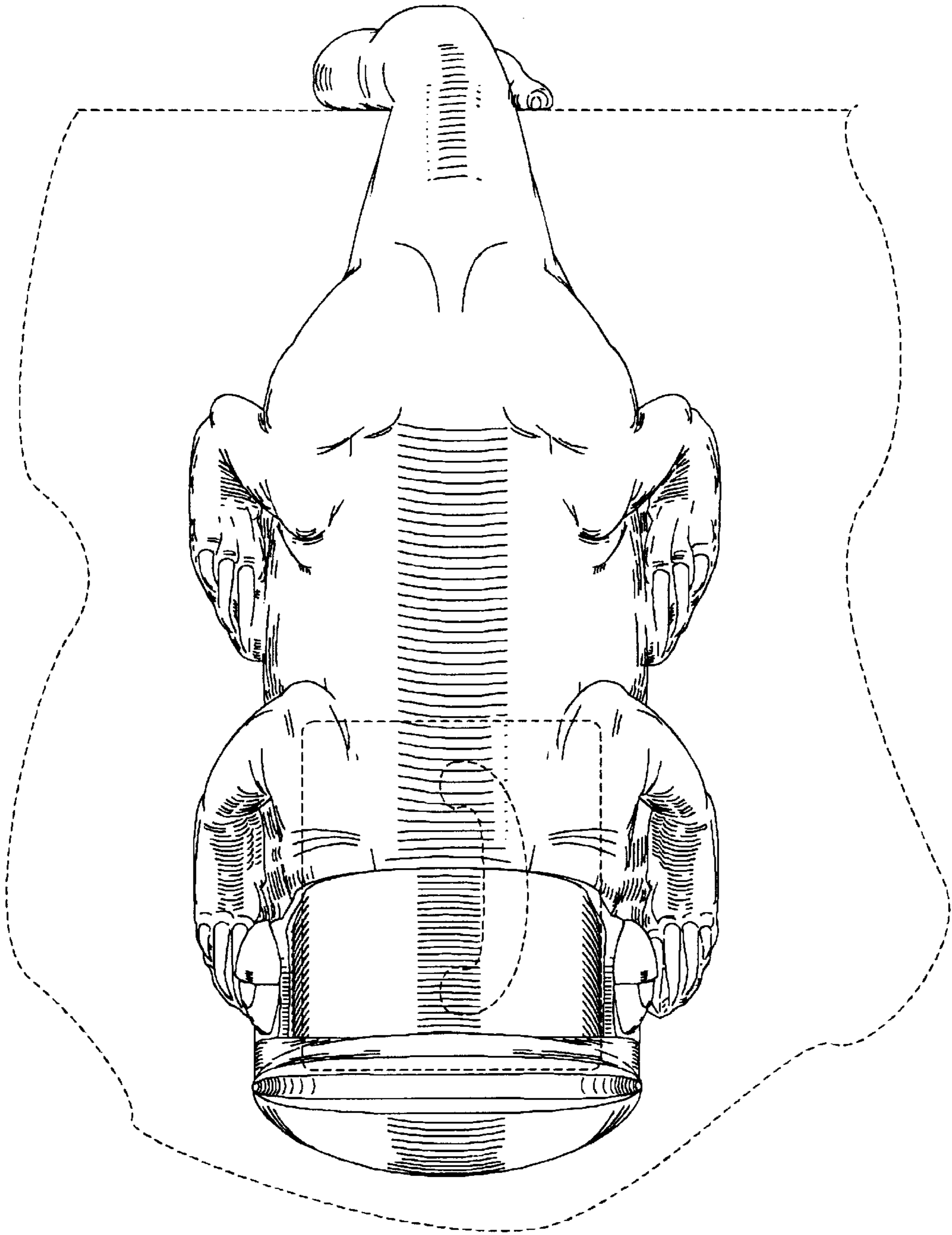

Fig. 3

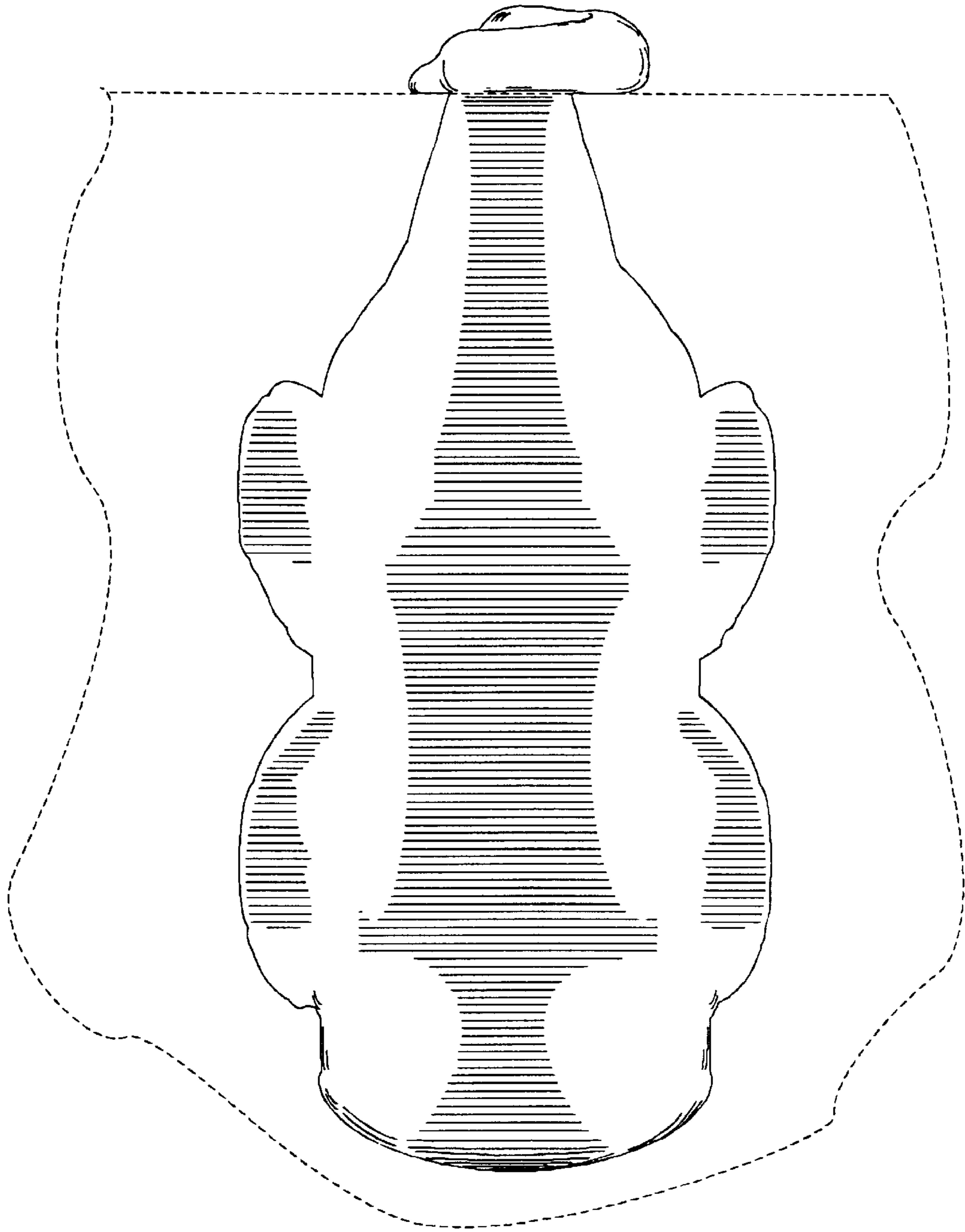

Fig. 4

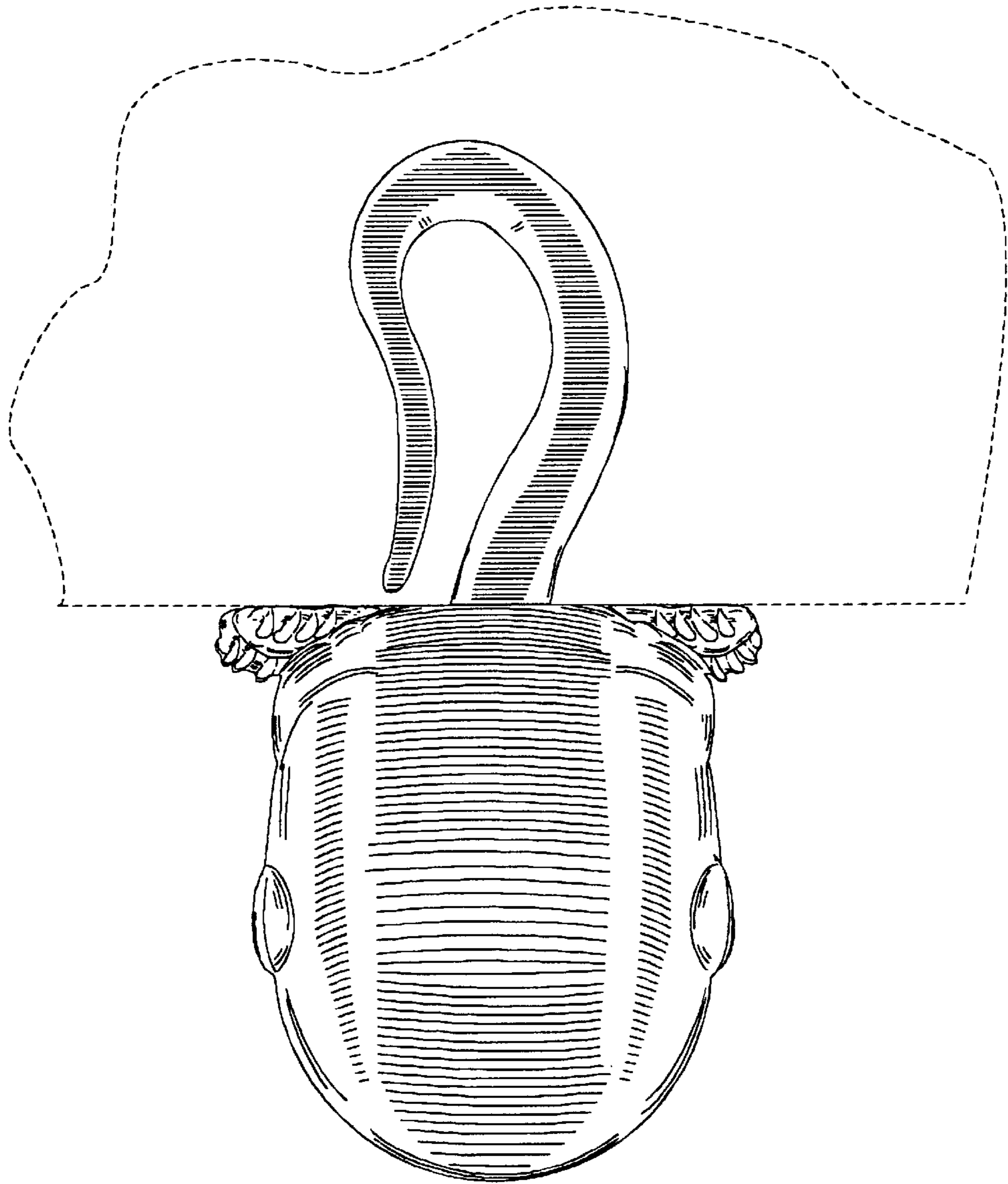

Fig. 5

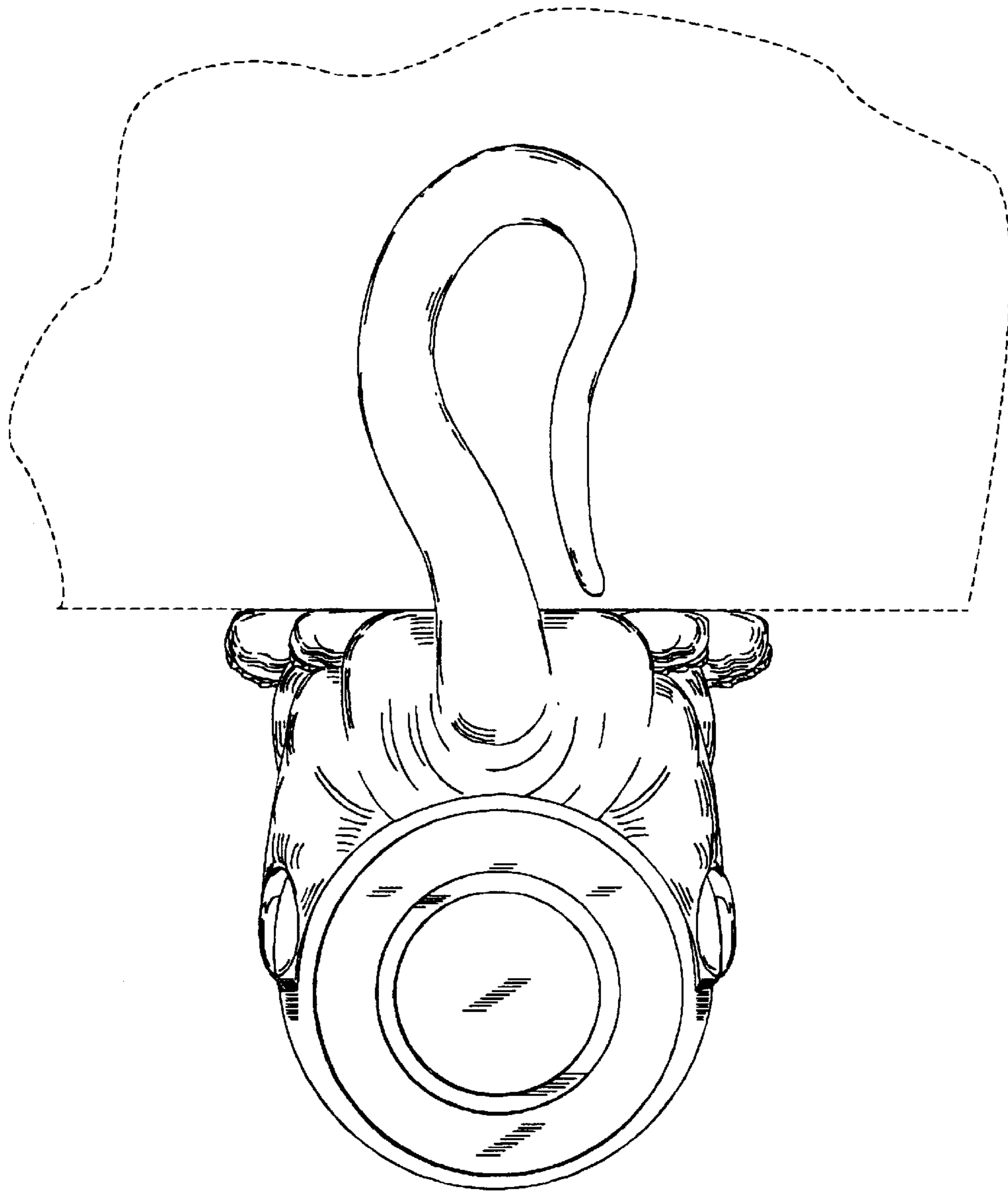

Fig. 6

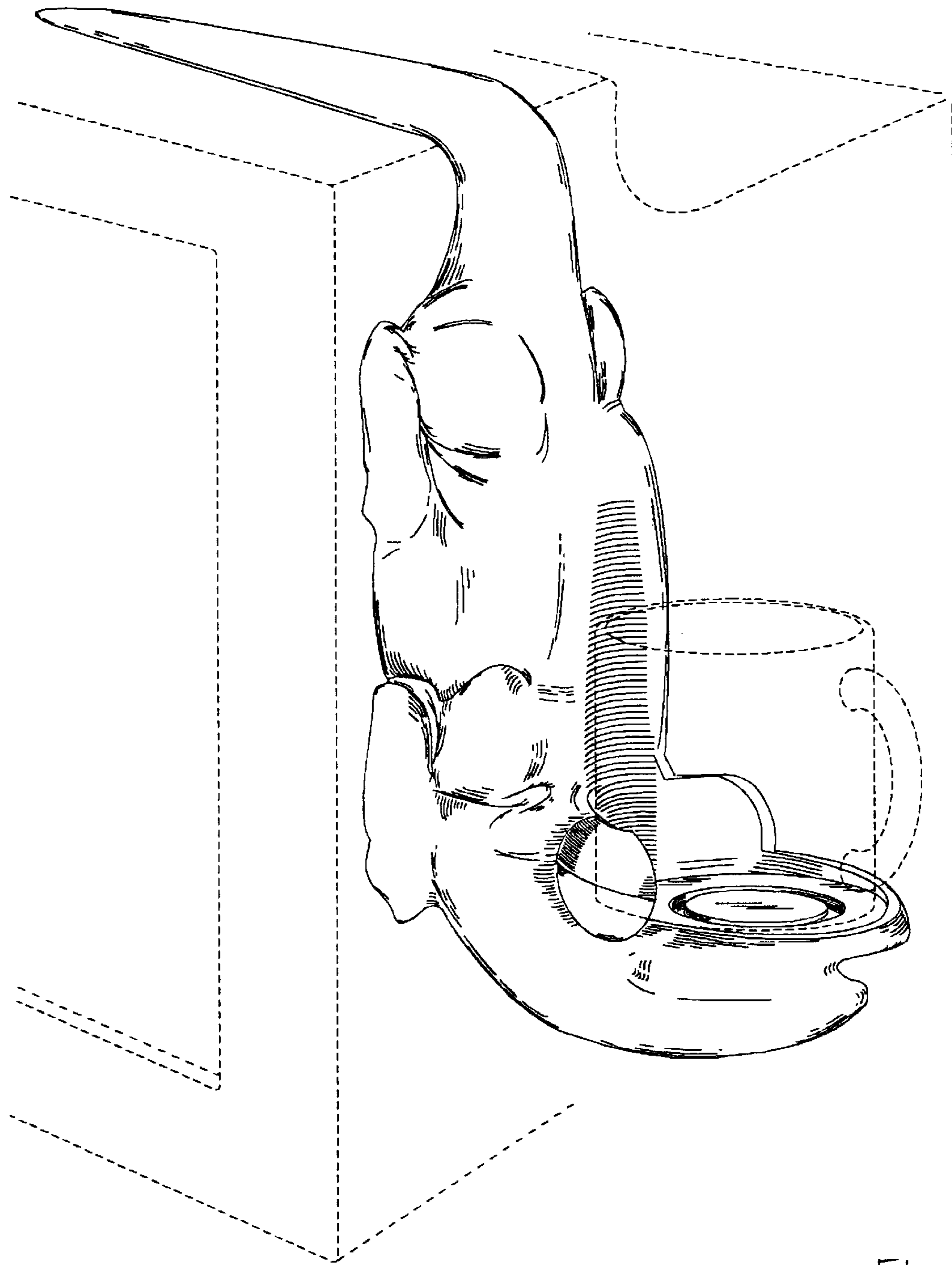

Fig. 7

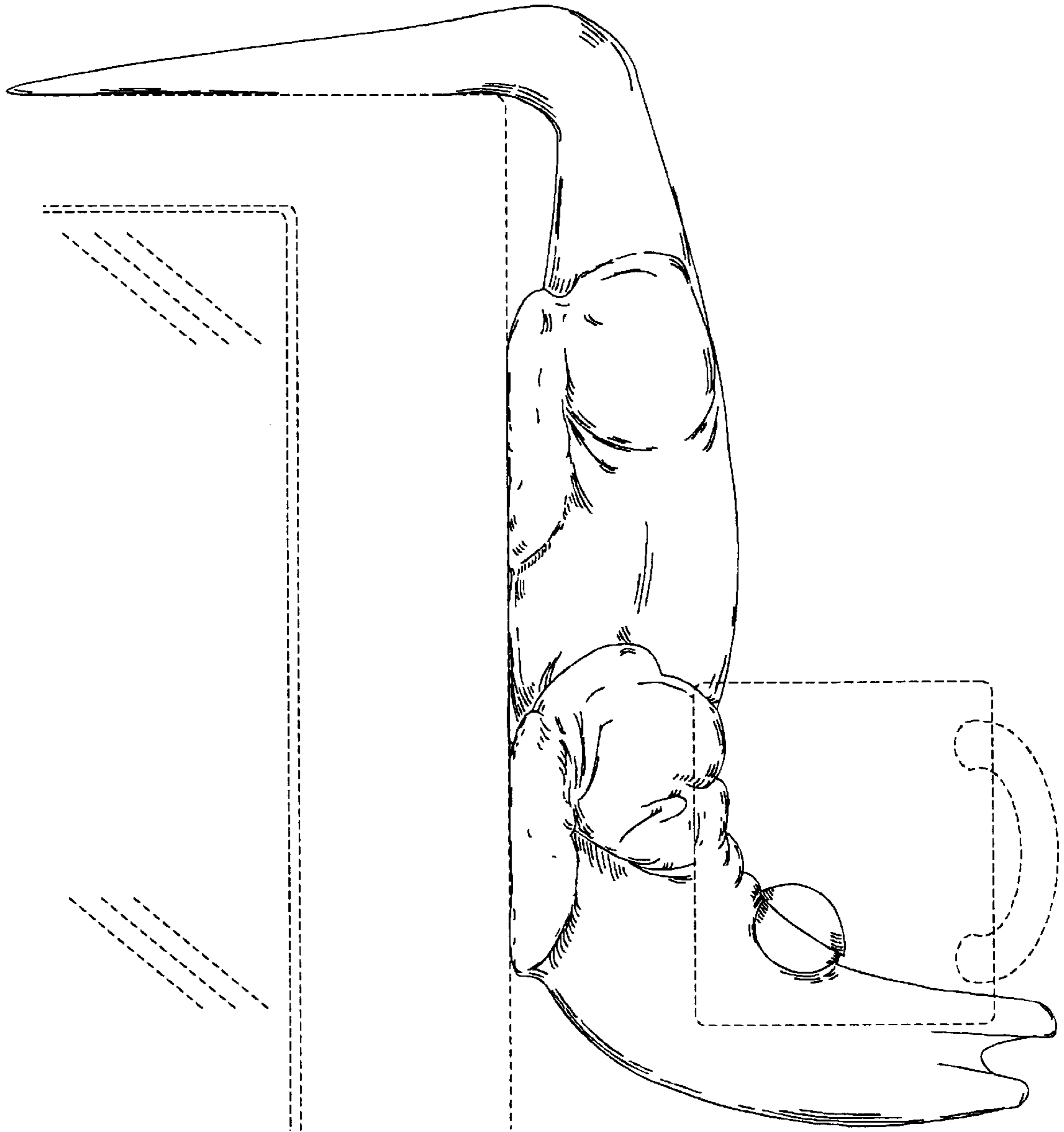

Fig. 8

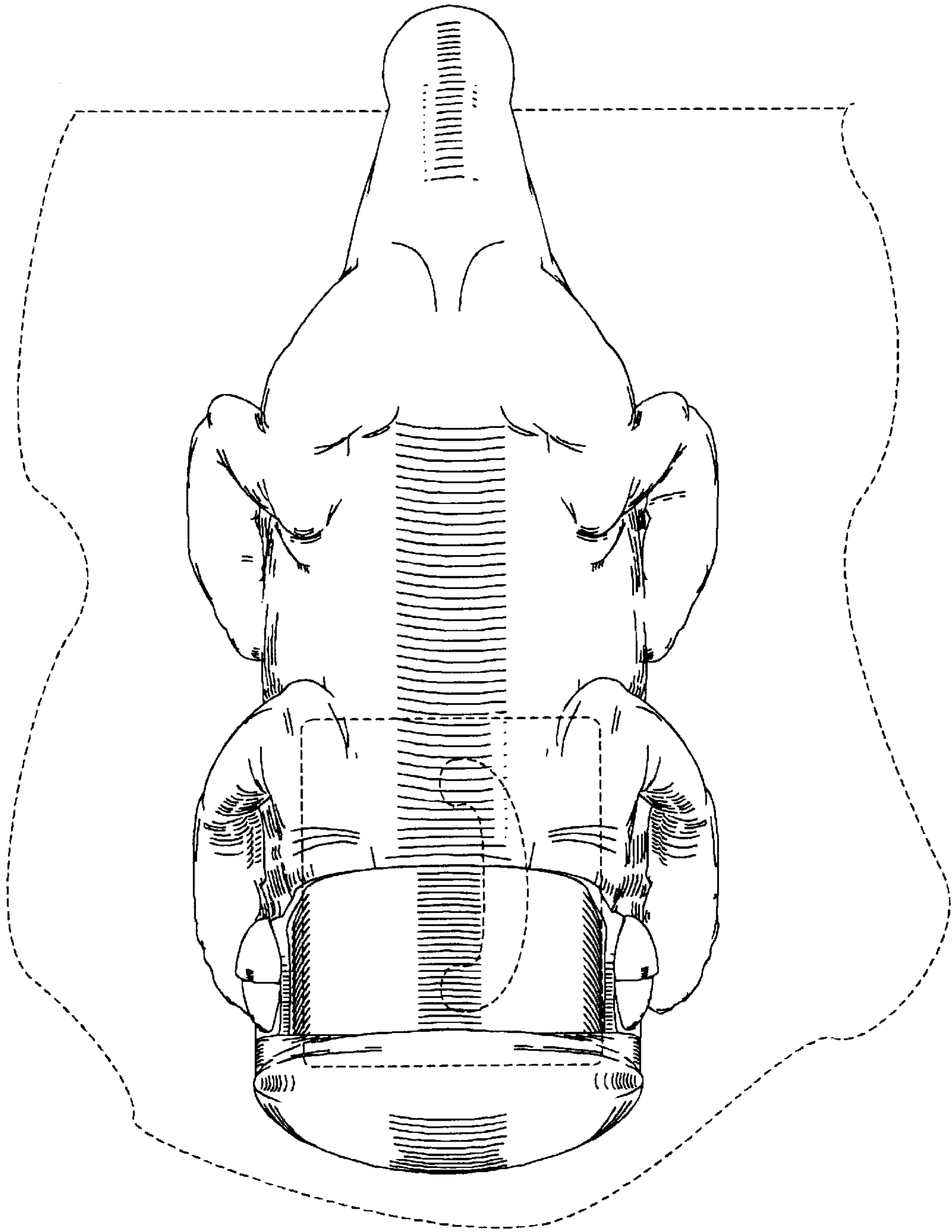

Fig. 9

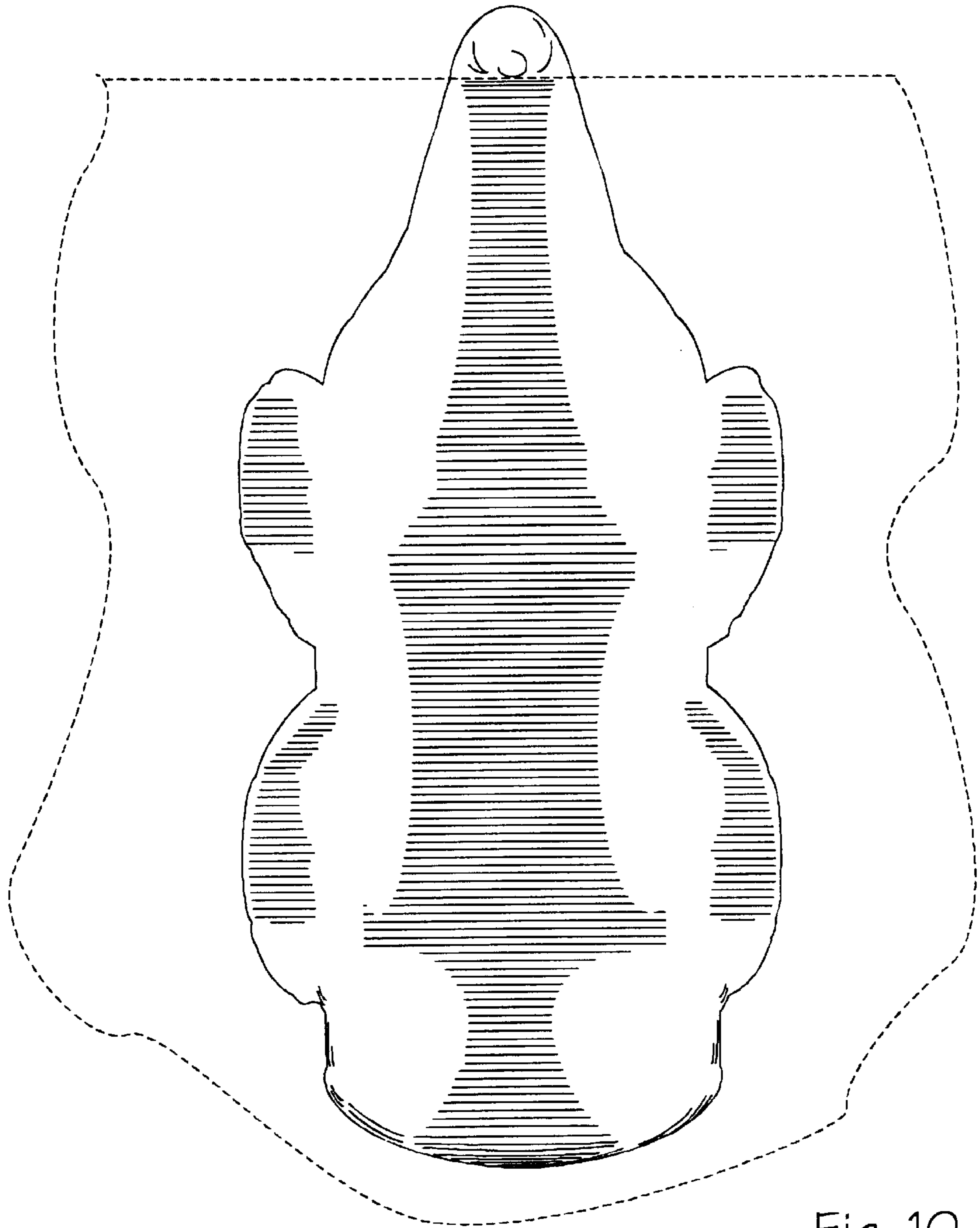

Fig. 10

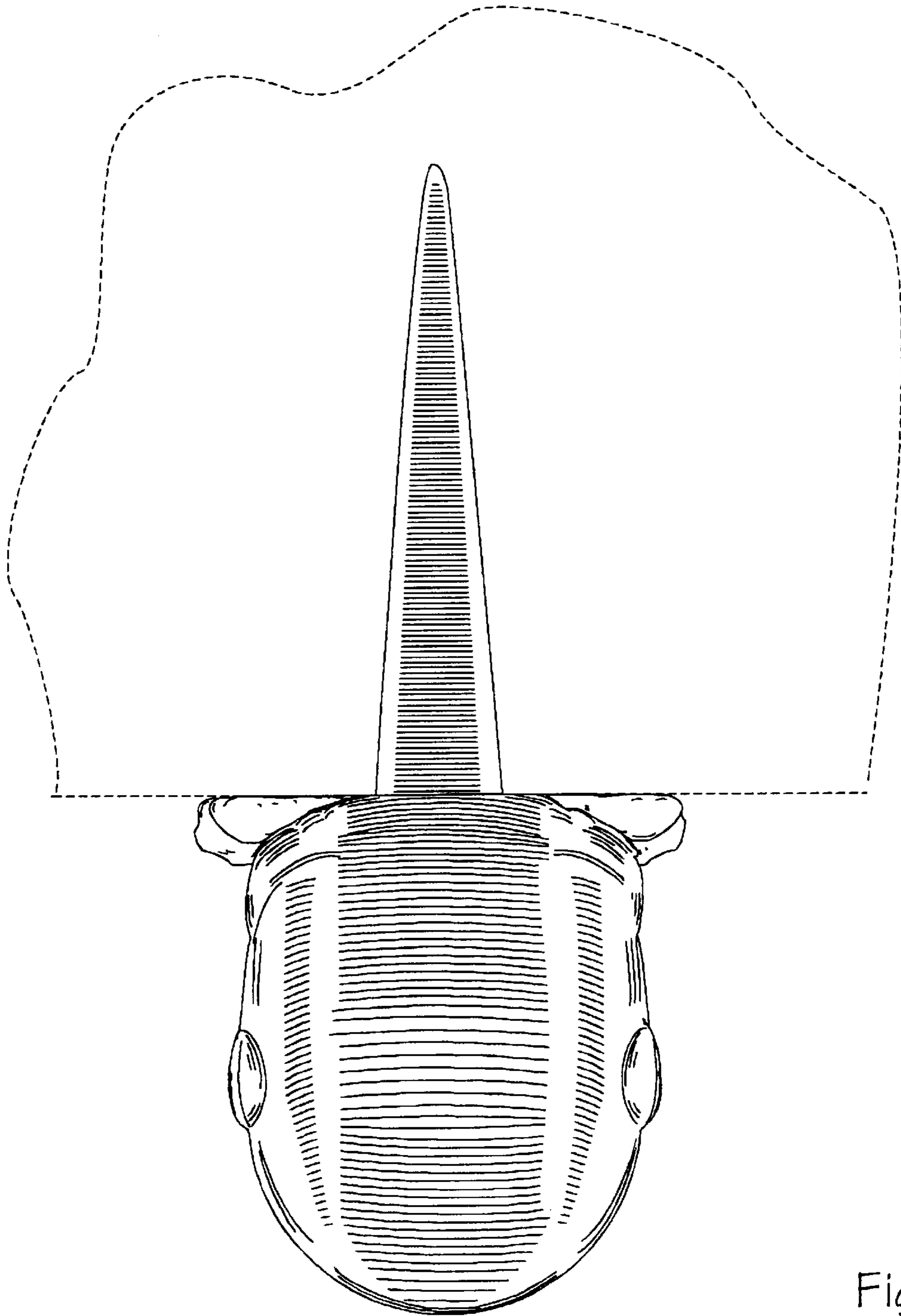

Fig. 11

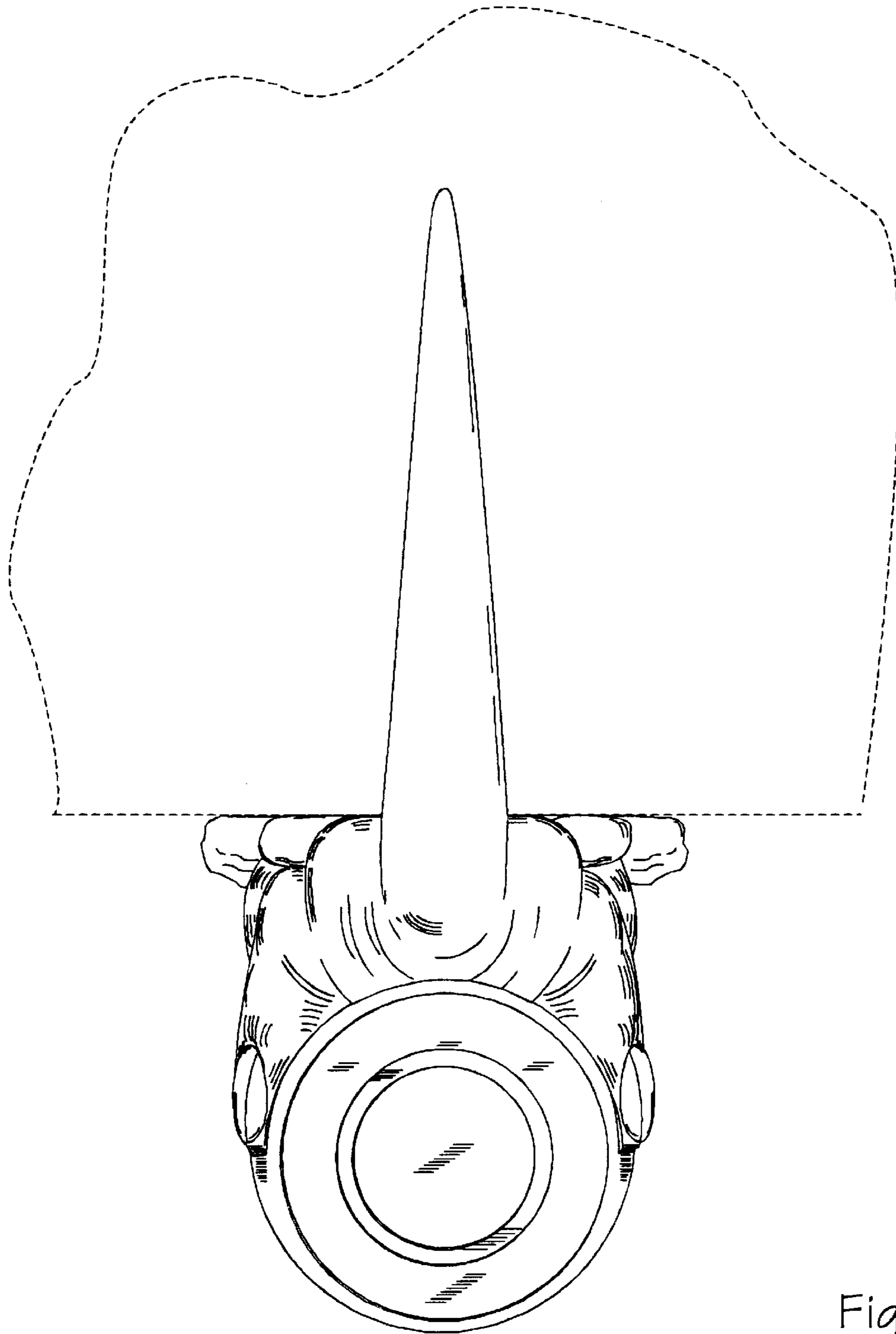

Fig. 12