



US00D416682S

United States Patent [19] Tanji

[11] Patent Number: Des. 416,682

[45] Date of Patent: ** Nov. 23, 1999

[54] BOX

[75] Inventor: **Hiroyuki Tanji**, Miyagi, Japan

[73] Assignee: **Iris Ohyama, Inc.**, Sendai, Japan

[**] Term: **14 Years**

[21] Appl. No.: **29/078,548**

[22] Filed: **Oct. 30, 1997**

[30] Foreign Application Priority Data

May 16, 1997	[JP]	Japan	9-54613
May 16, 1997	[JP]	Japan	9-54614

[51] LOC (6) Cl. **03-01**

[52] U.S. Cl. **D3/294; D3/905; D3/281; D3/291**

[58] Field of Search D3/273, 276, 281, D3/282, 294, 905, 295, 291; D9/424; 190/110, 111, 112; 206/315.1, 349, 372, 373, 378

[56] References Cited

U.S. PATENT DOCUMENTS

D. 228,580	10/1973	Schurman	D3/281
D. 312,173	11/1990	Smith et al.	D3/291
D. 314,666	2/1991	Lanius	D3/905
D. 315,247	3/1991	Lovell	D3/281
D. 321,433	11/1991	Dickinson	D3/905
D. 337,198	7/1993	Chauvin	D3/291
D. 341,294	11/1993	Doxey	D3/291
D. 361,659	8/1995	Kahl et al.	D3/905
D. 361,888	9/1995	Kahl et al.	D3/905
4,775,199	10/1988	Lanius et al.	312/220
5,193,706	3/1993	Hanna et al.	220/324

FOREIGN PATENT DOCUMENTS

920374	2/1995	Japan .
946500	2/1996	Japan .

Primary Examiner—Philip S. Hyder
Attorney, Agent, or Firm—Foley & Lardner

[57] CLAIM

The ornamental design for a box, as shown and described.

DESCRIPTION

FIG. 1 is a top plan view of a box showing my new design; FIG. 2 is a front elevational view thereof; FIG. 3 is a rear elevational view thereof; FIG. 4 is a first right side elevational view thereof, a first left side elevational view thereof being a mirror image; FIG. 5 is a second right side elevational view thereof wherein the handle portion is in the upright position, a second left side elevational view thereof being a mirror image; FIG. 6 is a third right side elevational view thereof wherein the latch is in the off position, the cover is in the open position and the front lid portion is in the open position, a third left side elevational view thereof being a mirror image; FIG. 7 is a top plan view of a second embodiment of a box showing my new design; FIG. 8 is a front elevational view thereof; FIG. 9 is a rear elevational view thereof; FIG. 10 is a first right side elevational view thereof, a first left side elevational view being a mirror image; FIG. 11 is a second right side elevational view thereof wherein the handle portion is in the upright position, a second left side elevational view thereof being a mirror image; and FIG. 12 is a third right side elevational view thereof wherein the latch is in the off position, the cover is in the open position and the front lid portion is in the open position, a third left side elevational view thereof being a mirror image; and, FIG. 13 is a reference top plan view thereof wherein the cover is in the open position.

1 Claim, 5 Drawing Sheets

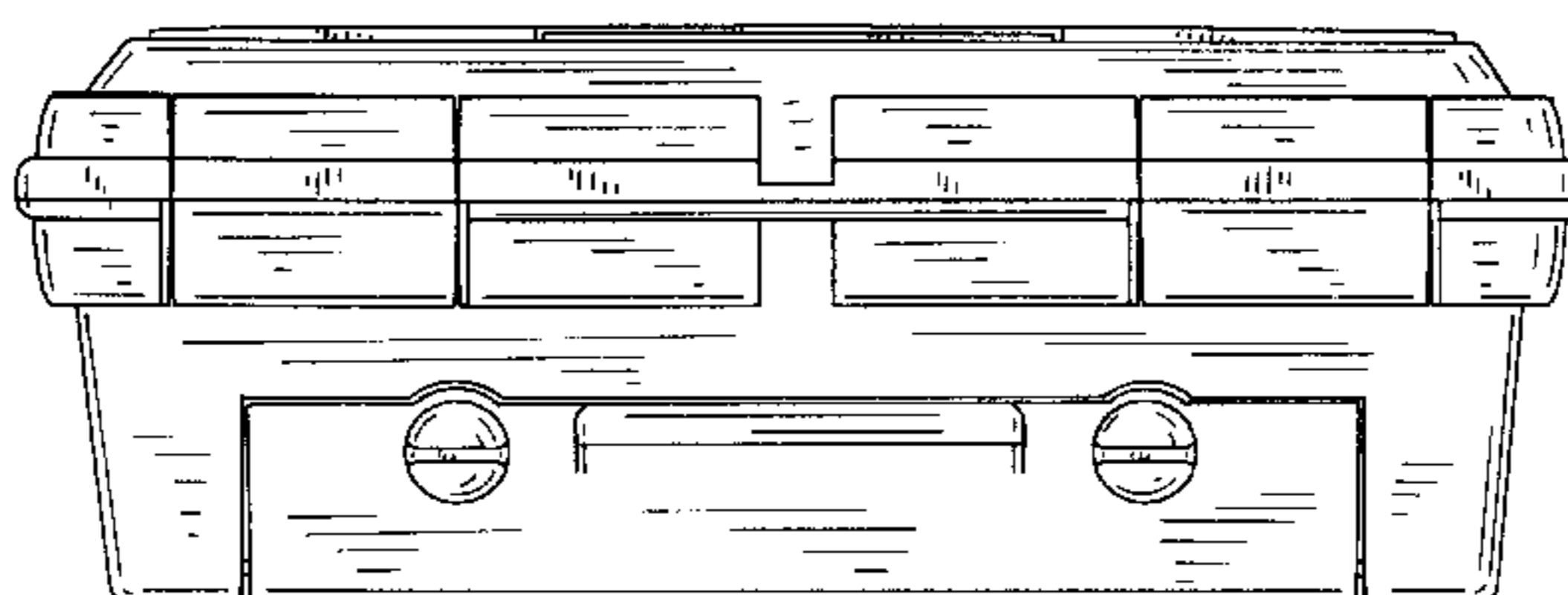
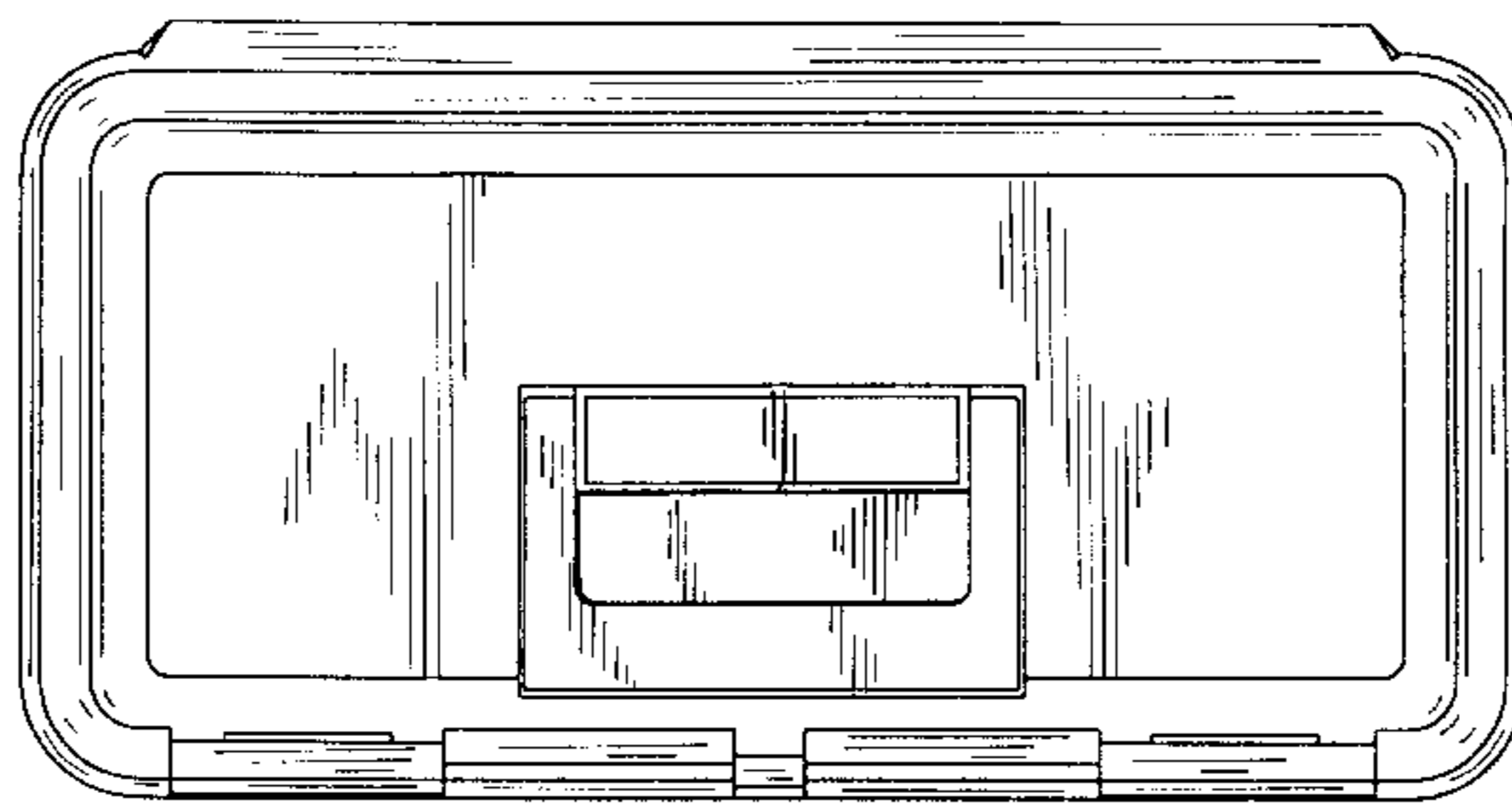

FIG. 1

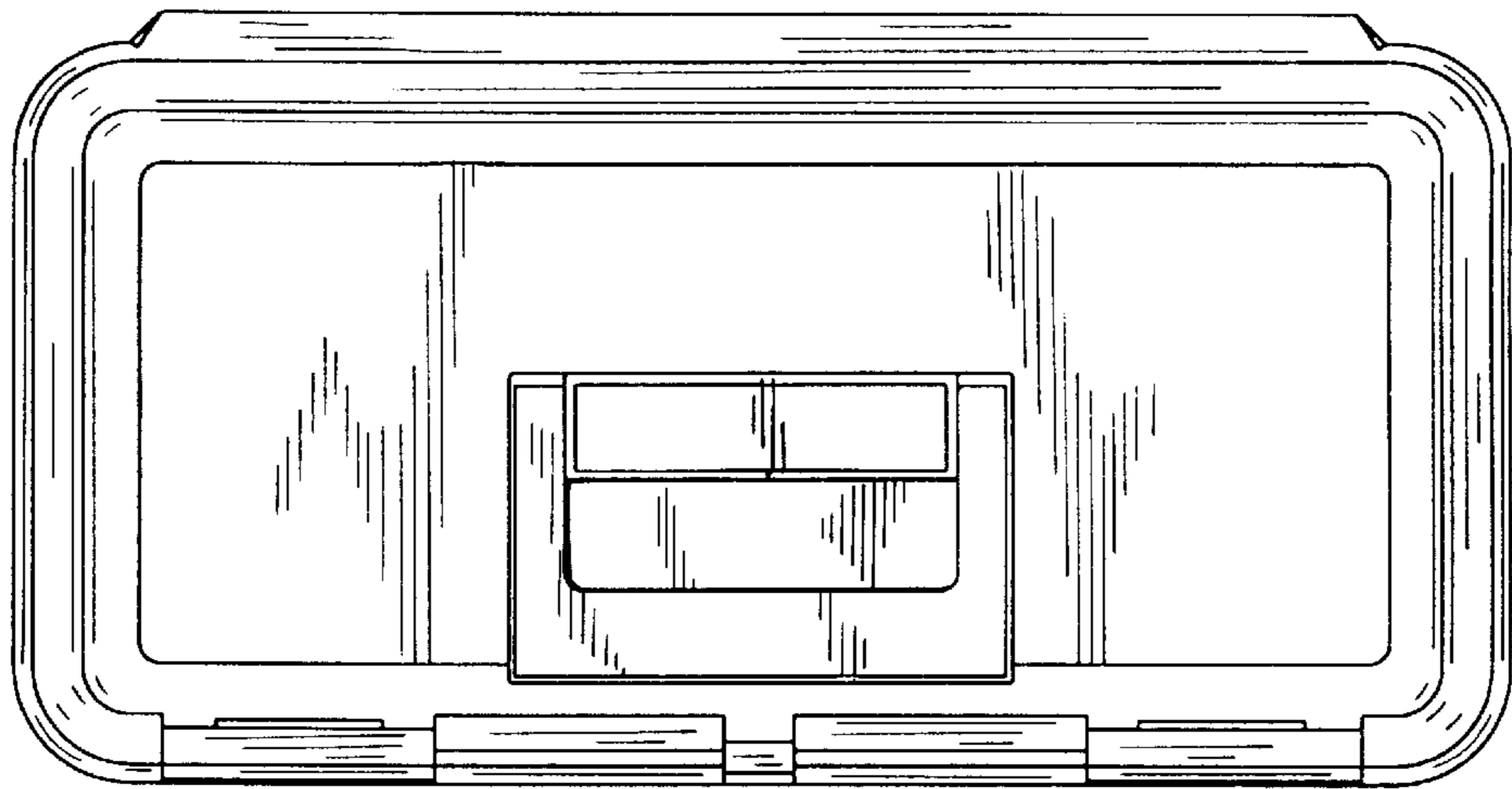

FIG. 2

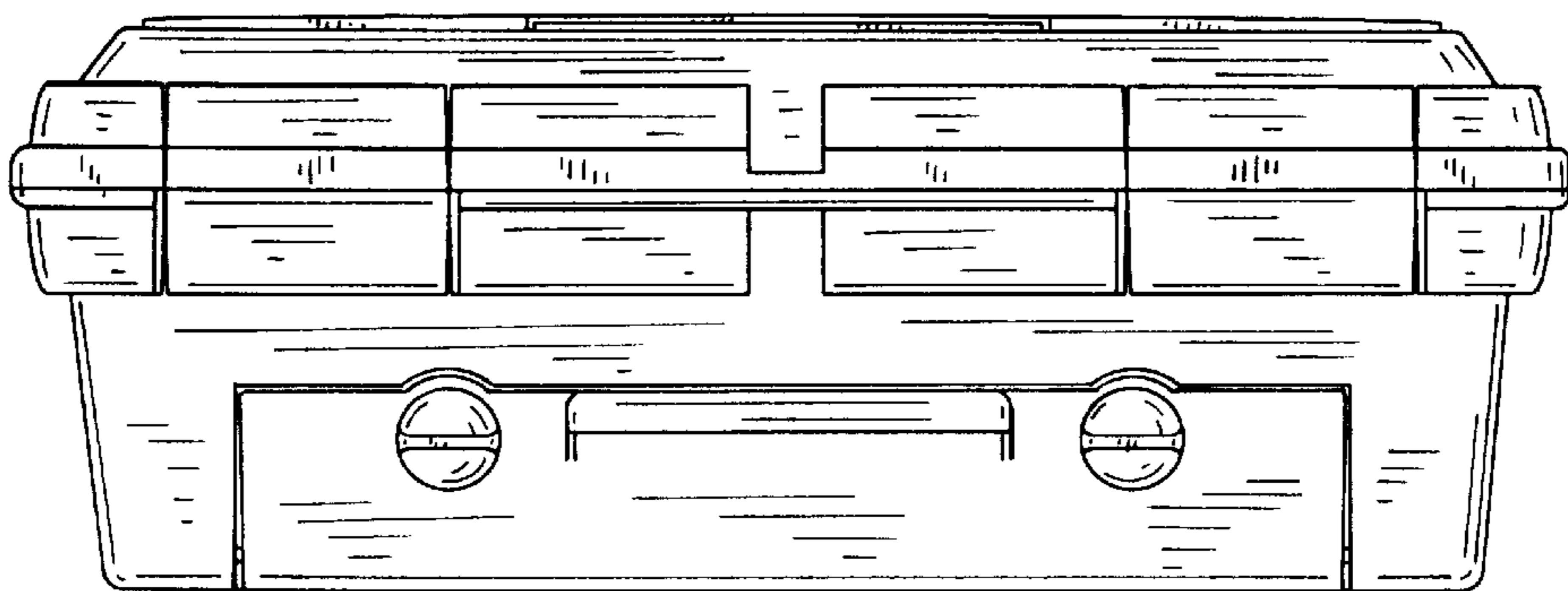

FIG. 3

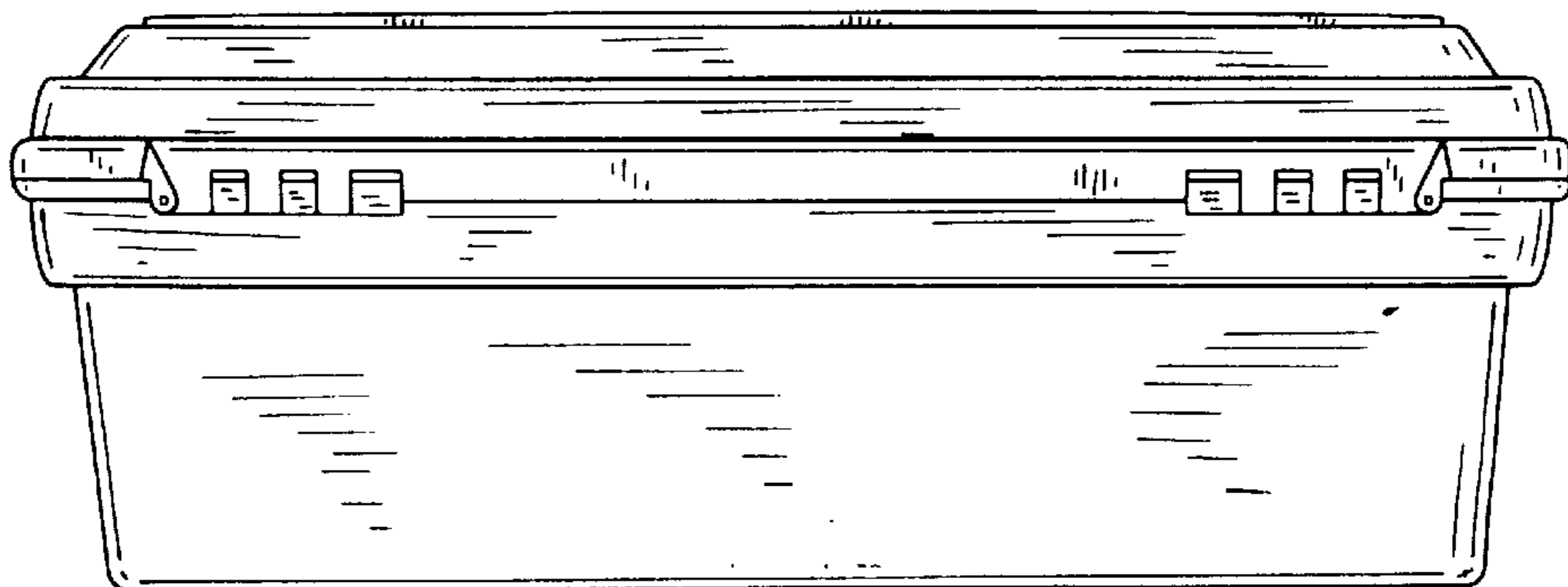

FIG. 4

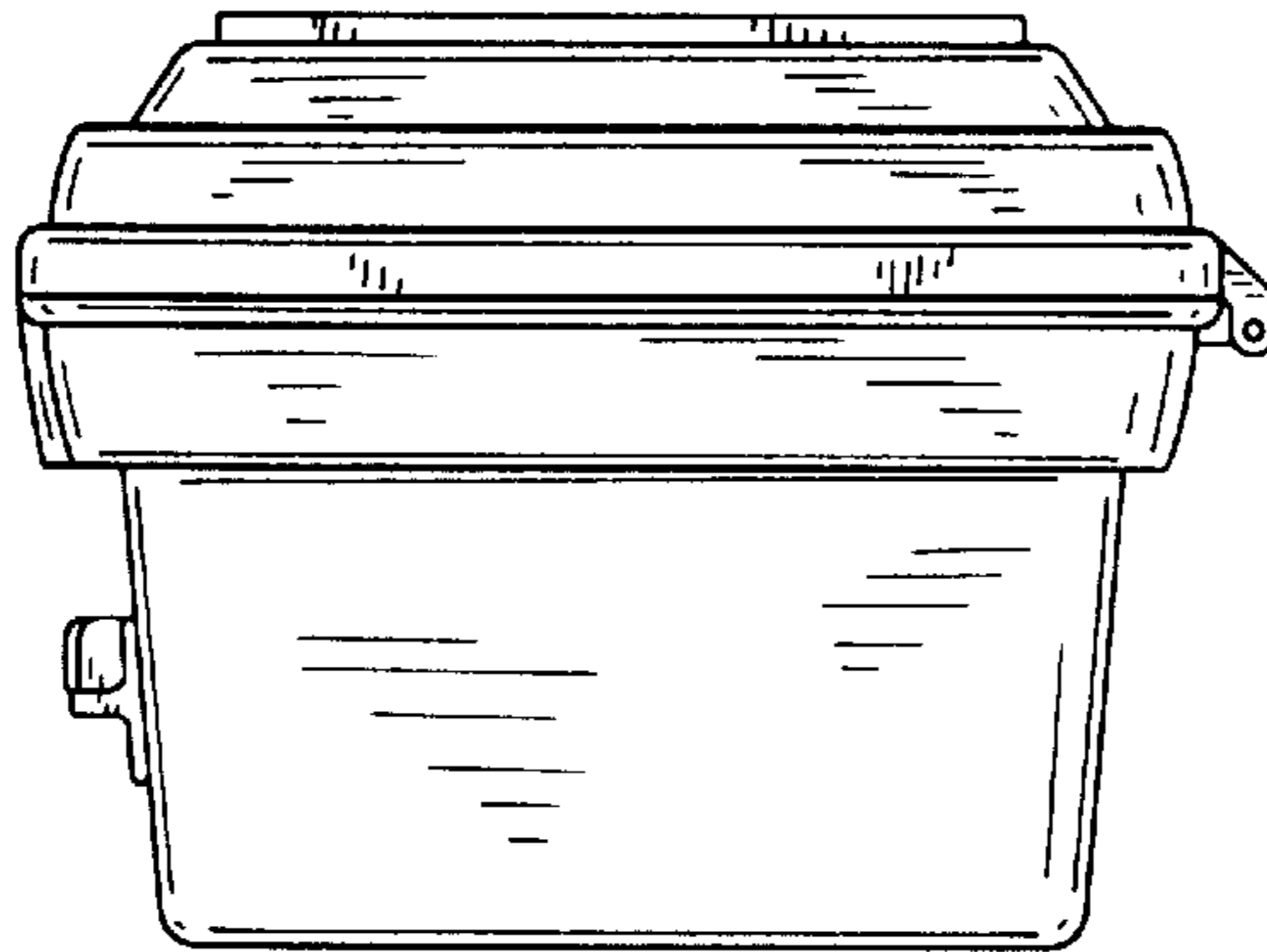

FIG. 5

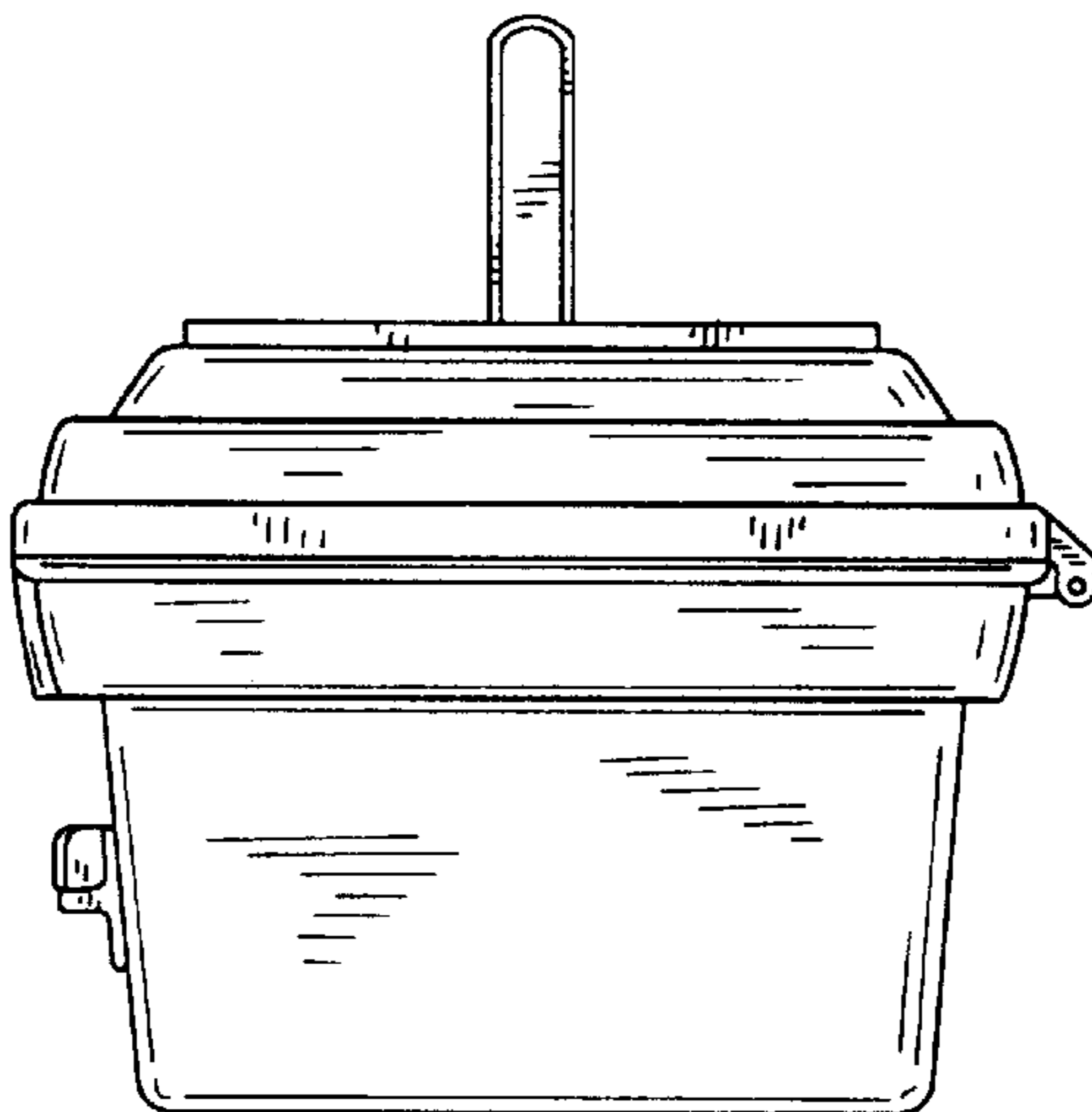

FIG. 6

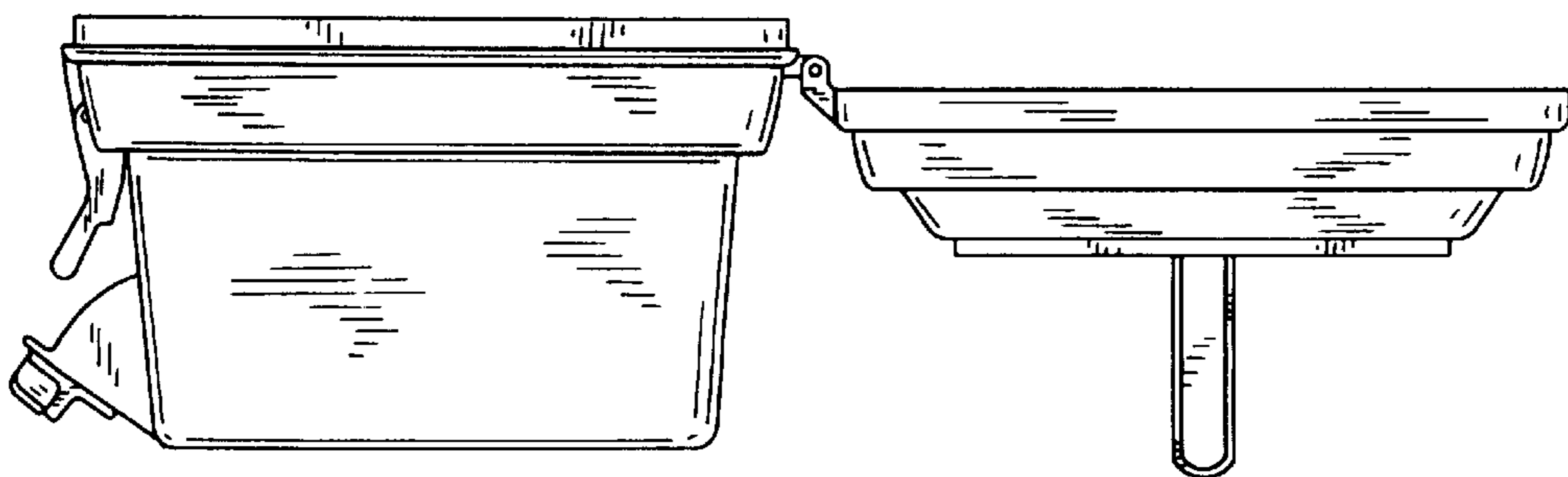

FIG. 7

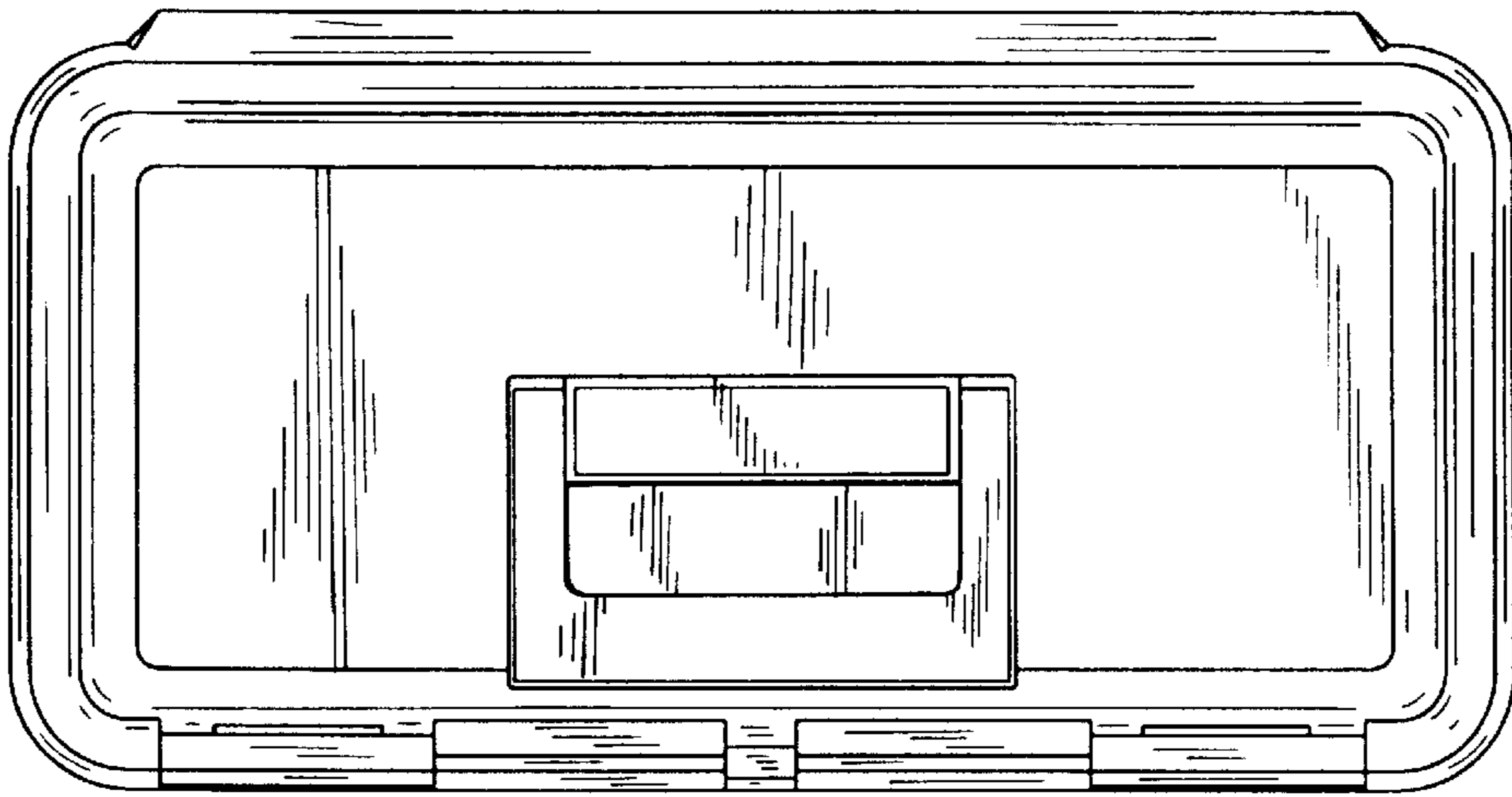

FIG. 8

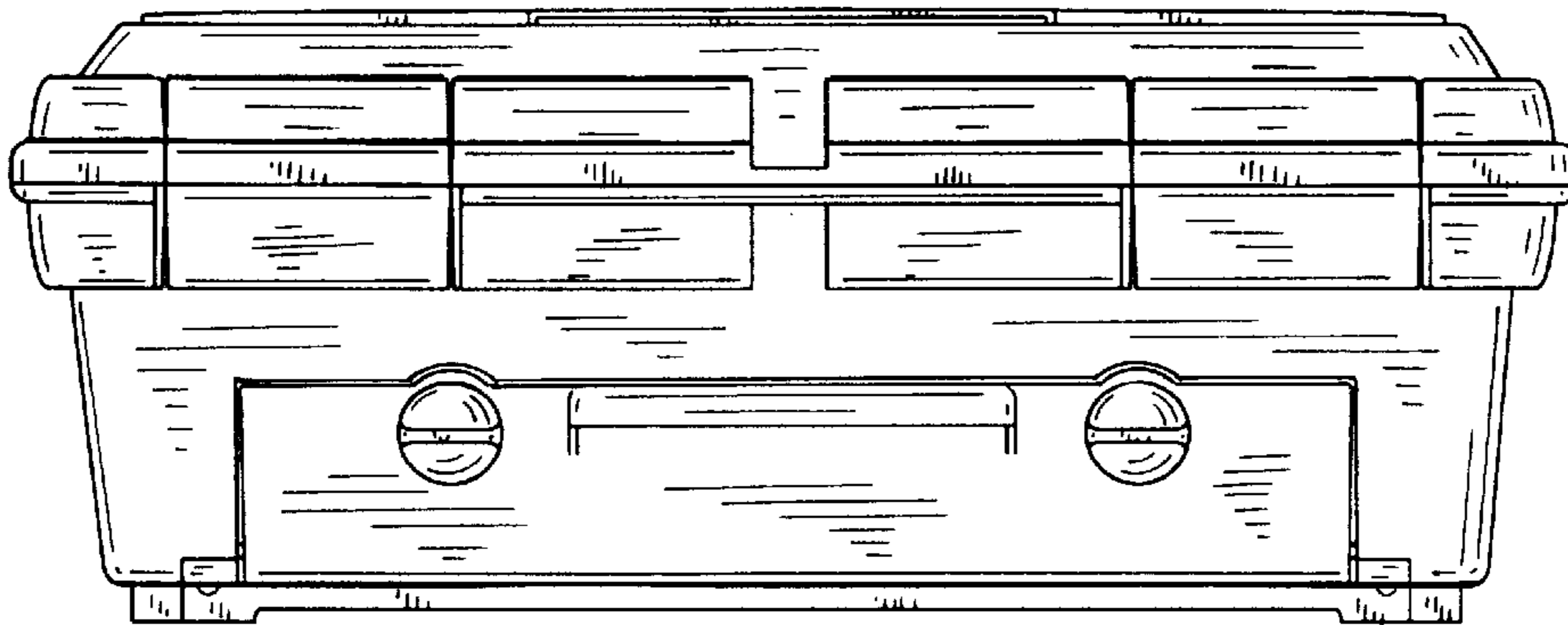

FIG. 9

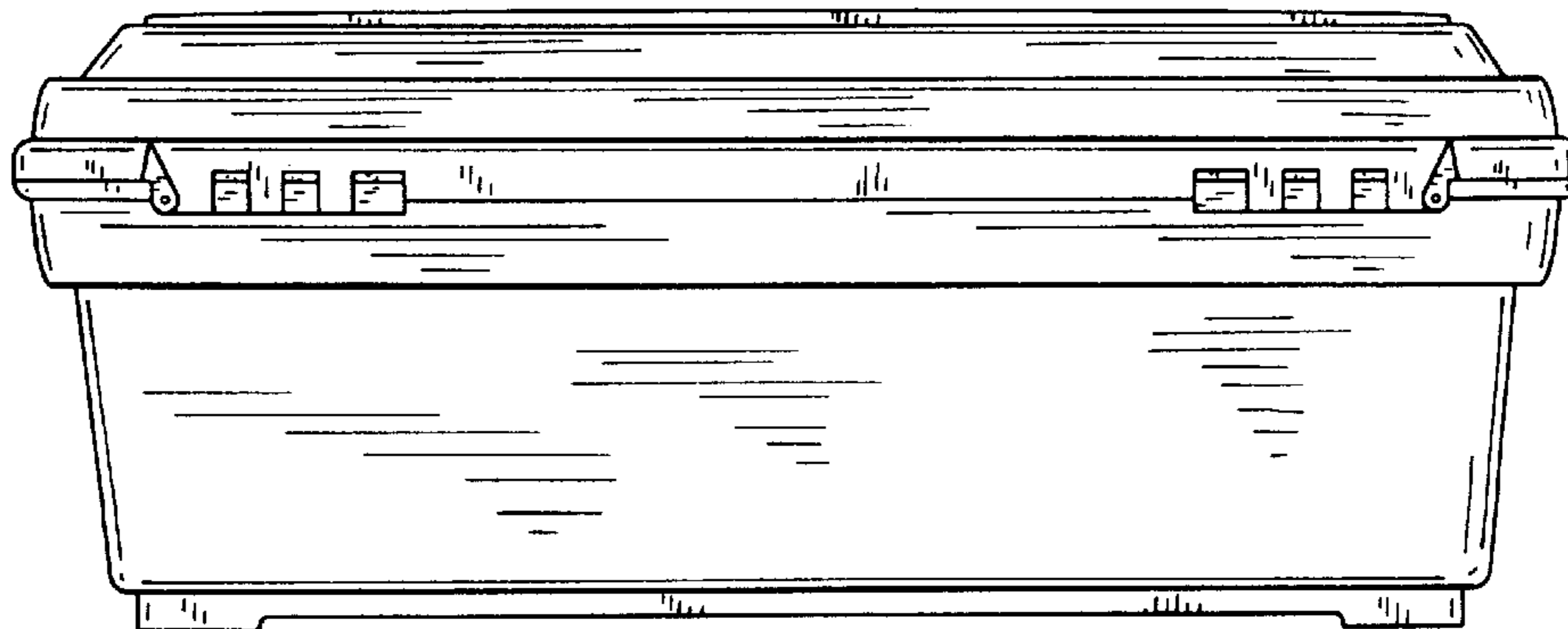

FIG. 10

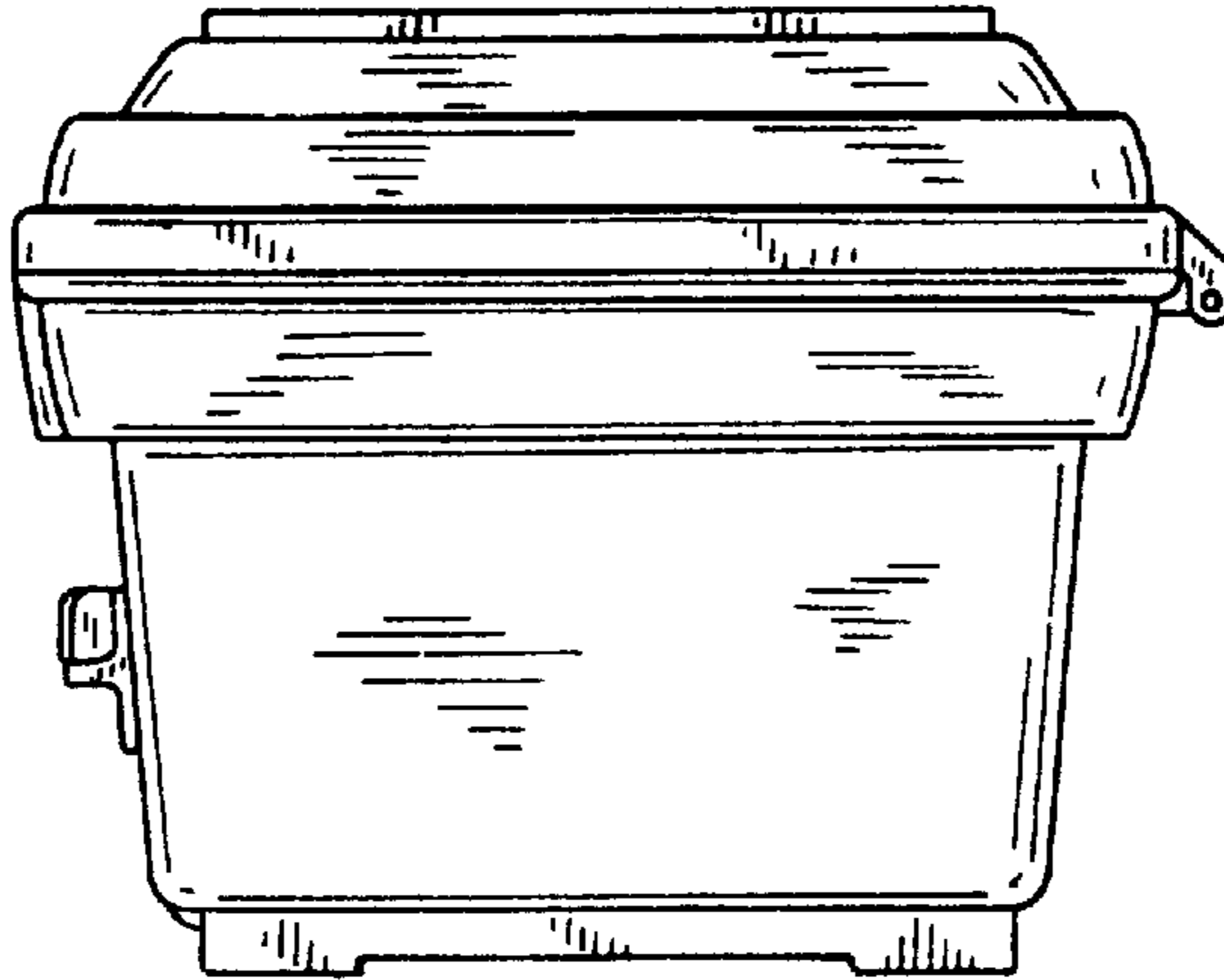

FIG. 11

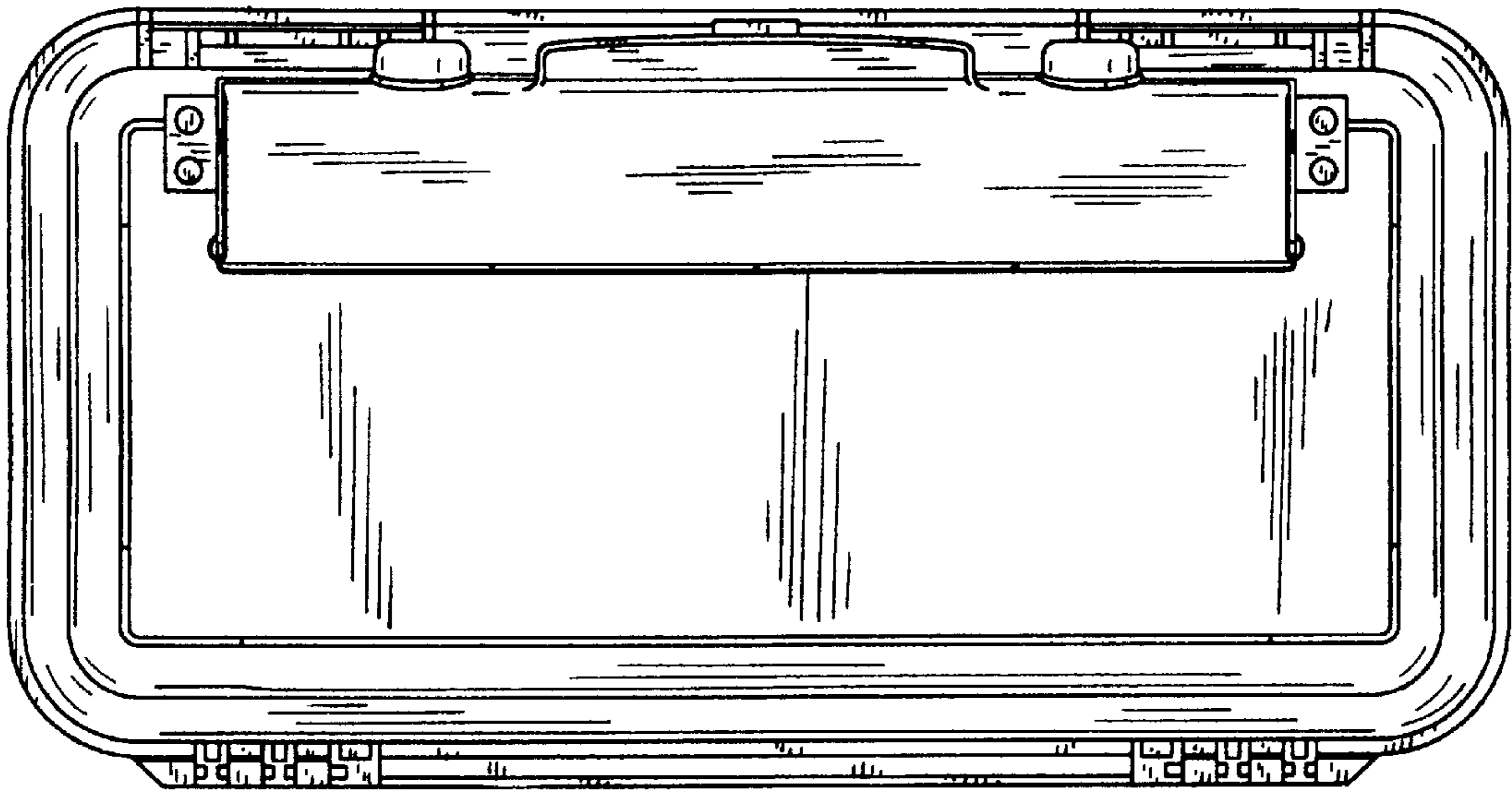

FIG. 12

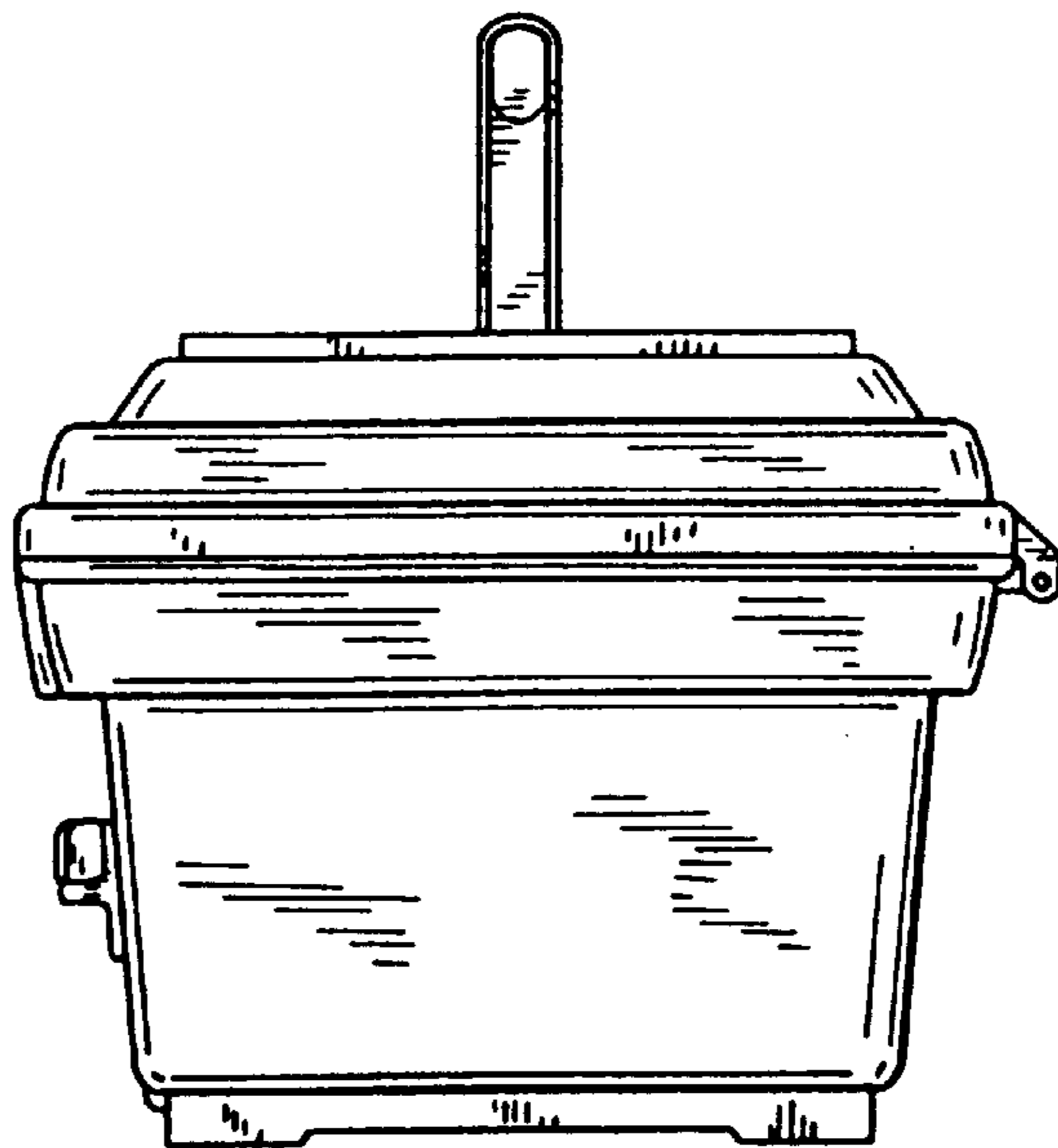

FIG. 13

