



US00D416615S

United States Patent [19] Brummer

[11] Patent Number: **Des. 416,615**

[45] Date of Patent: **** Nov. 16, 1999**

[54] **CHIMNEY TOP**

[76] Inventor: **Daryl J. Brummer**, 1704 W. Lake Shore Dr., Delafield, Wis. 53018

[**] Term: **14 Years**

[21] Appl. No.: **29/076,824**

[22] Filed: **Sep. 17, 1997**

4,202,255 5/1980 McNamara .
5,094,050 3/1992 Jenkins .
5,125,869 6/1992 VonSick .

Primary Examiner—Lisa Lichtenstein
Attorney, Agent, or Firm—Andrus, Scales, Starke & Sawall

Related U.S. Application Data

[62] Division of application No. 29/039,903, Jun. 7, 1995, Pat. No. Des. 388,512.

[51] **LOC (6) Cl.** **23-04**

[52] **U.S. Cl.** **D23/374; D23/373**

[58] **Field of Search** D23/373, 374, D23/376; 454/4, 367, 3, 13, 14, 15, 20, 21, 22

[56] References Cited

U.S. PATENT DOCUMENTS

- 94,864 9/1869 Boyd .
- D. 135,628 5/1943 Heiman .
- 181,936 9/1876 Greaves .
- D. 191,018 8/1961 Kearney et al. .
- 205,418 6/1878 Richard .
- D. 255,487 6/1980 Foley .
- 293,043 2/1884 Lenhart .
- 403,478 5/1889 Meriam .
- 517,919 4/1894 Frerichs .
- 761,680 6/1904 Jacobson .
- 972,378 10/1910 Huffman et al. .
- 1,271,166 7/1918 Hutton .
- 1,672,291 6/1928 Williams .
- 2,635,526 4/1953 Anderson .
- 2,805,616 9/1957 Roth .
- 2,956,495 10/1960 Sublette .
- 3,087,409 4/1963 Carr .
- 3,267,832 8/1966 Hinkle .
- 3,654,850 4/1972 Berkus 454/4
- 4,020,754 5/1977 Dalsin et al. .
- 4,181,119 1/1980 Lyles .

[57] CLAIM

The ornamental design for a chimney top, as shown and described.

DESCRIPTION

FIG. 1 is a side elevation view of a chimney top showing my new design;
 FIG. 2 is a top plan view thereof;
 FIG. 3 is a front elevation view thereof;
 FIGS. 4 and 5 are views similar to FIGS. 1 and 3, respectively, showing another embodiment of my new design, with the top plan view thereof being identical to FIG. 2;
 FIGS. 6 and 7 are views similar to FIGS. 4 and 5, showing another embodiment of my new design, with the top view thereof being identical to FIG. 2;
 FIGS. 8 and 9 are views similar to FIGS. 6 and 7, showing another embodiment of my new design;
 FIG. 10 is a top plan view of the chimney top of FIGS. 8 and 9;
 FIGS. 11 and 12 are views similar to FIGS. 8 and 9, showing another embodiment of my new design;
 FIG. 13 is a top plan view of the embodiment illustrated in FIGS. 11 and 12;
 FIGS. 14 and 15 are front and side elevation views, respectively, showing another embodiment of my new design;
 FIG. 16 is a top plan view of the chimney top of FIGS. 14 and 15;
 FIG. 17 is a partial side elevation view of the design of FIGS. 14 and 15 taken along line 17—17 in FIG. 15;
 FIG. 18 is a partial side elevation view of the design of FIGS. 14 and 15 taken along line 18—18 in FIG. 15; and,
 FIG. 19 is a side elevation view of FIG. 18 with the chimney top damper in a raised position.

1 Claim, 9 Drawing Sheets

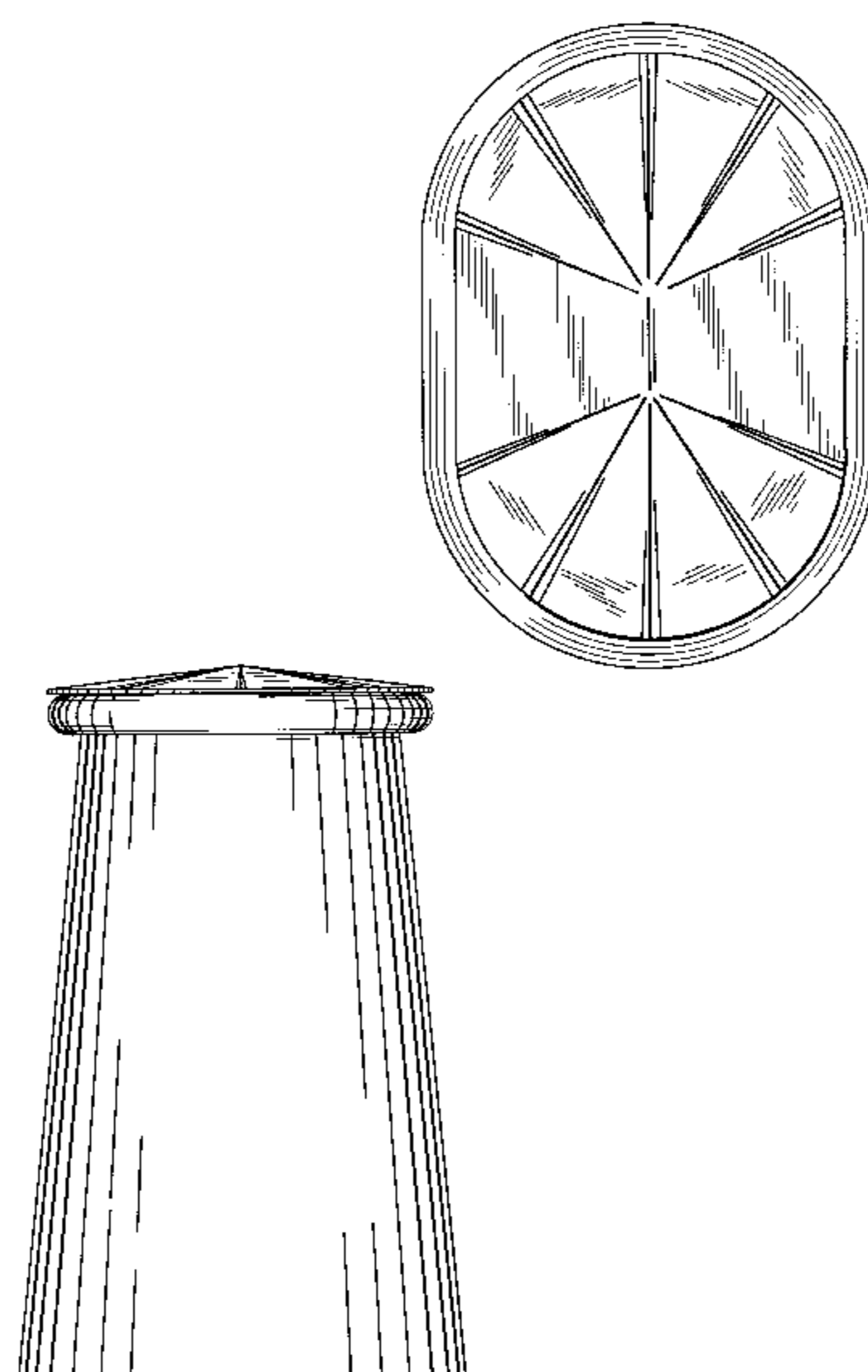

FIG. 2

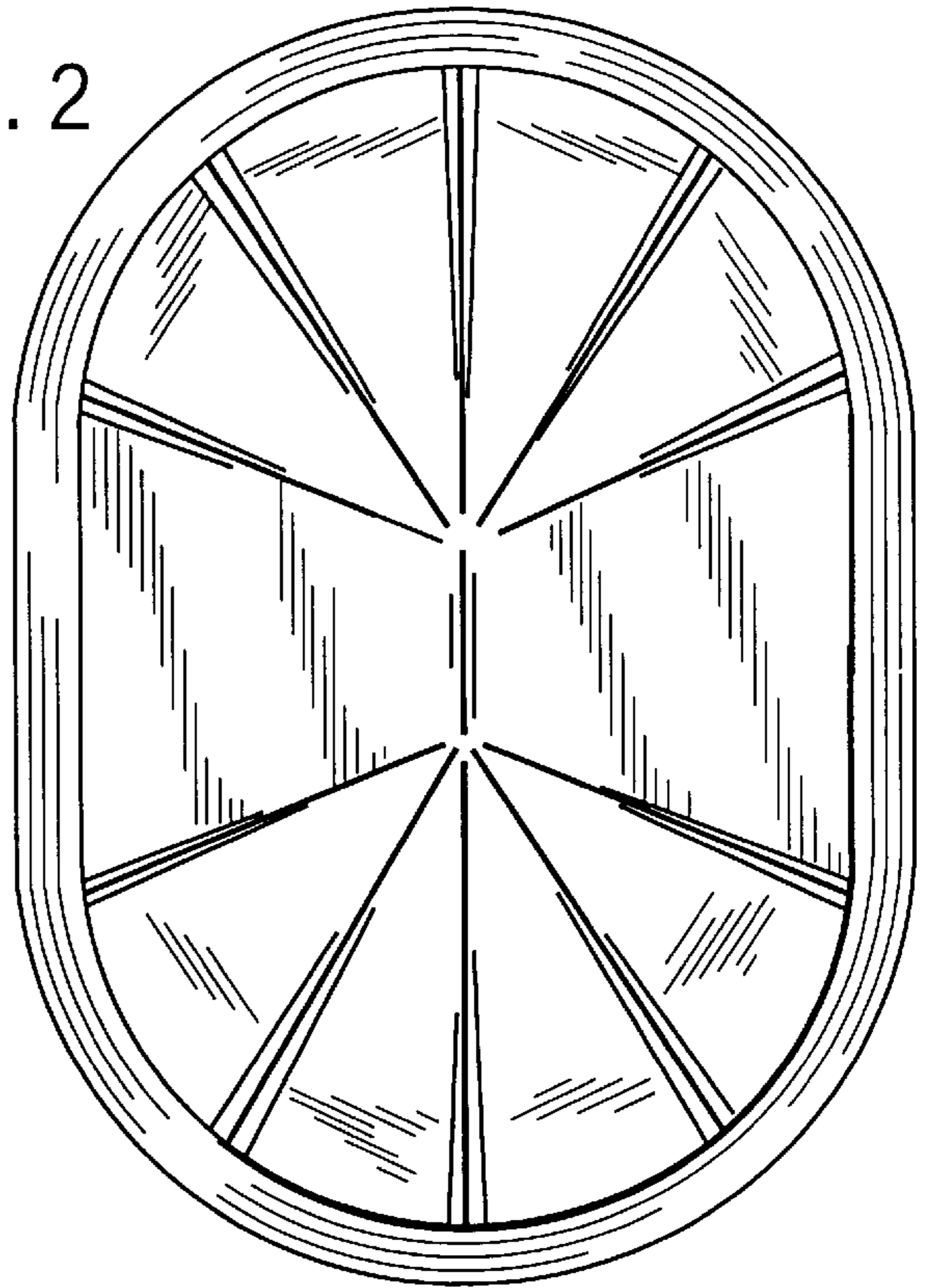
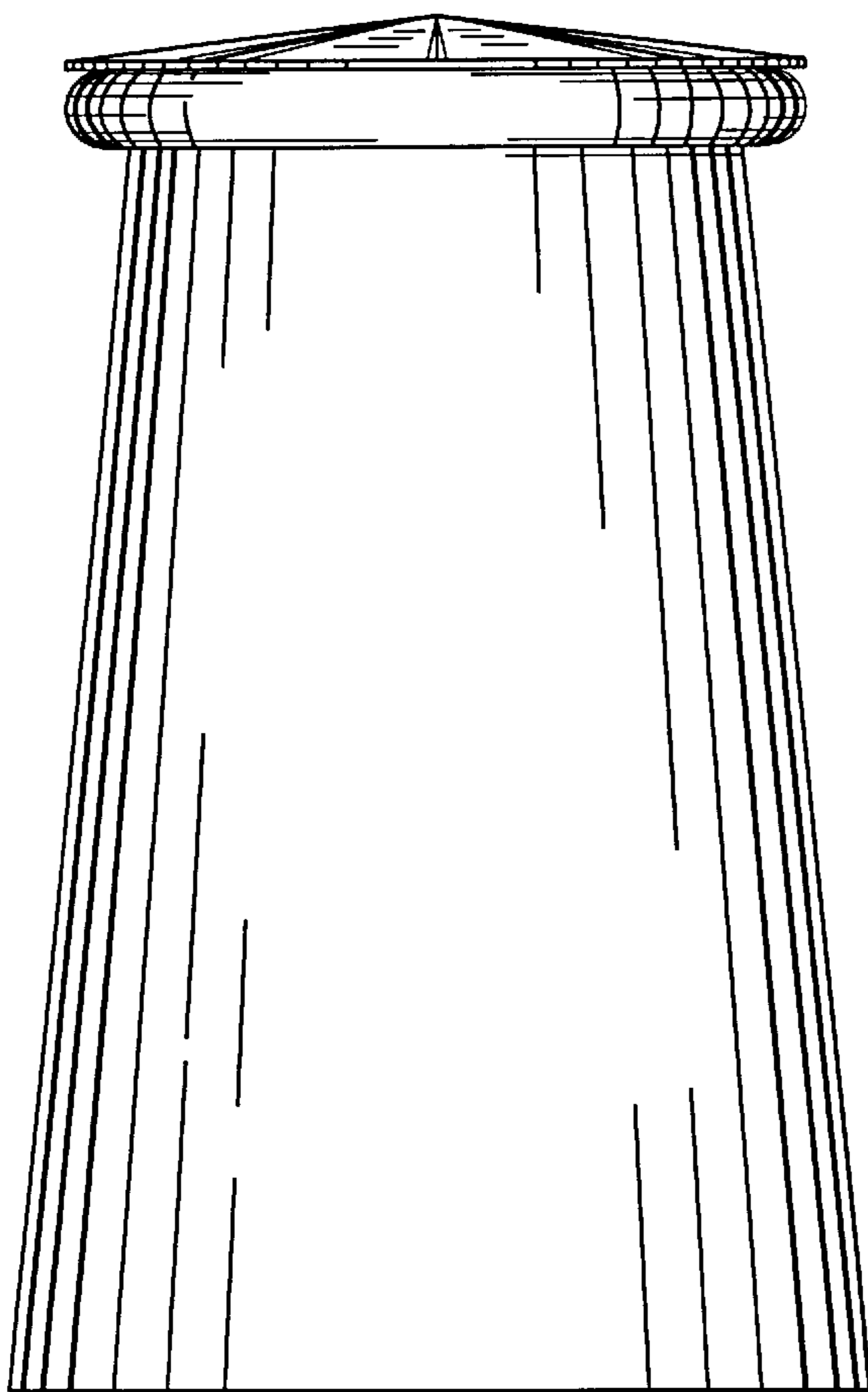

FIG. 1



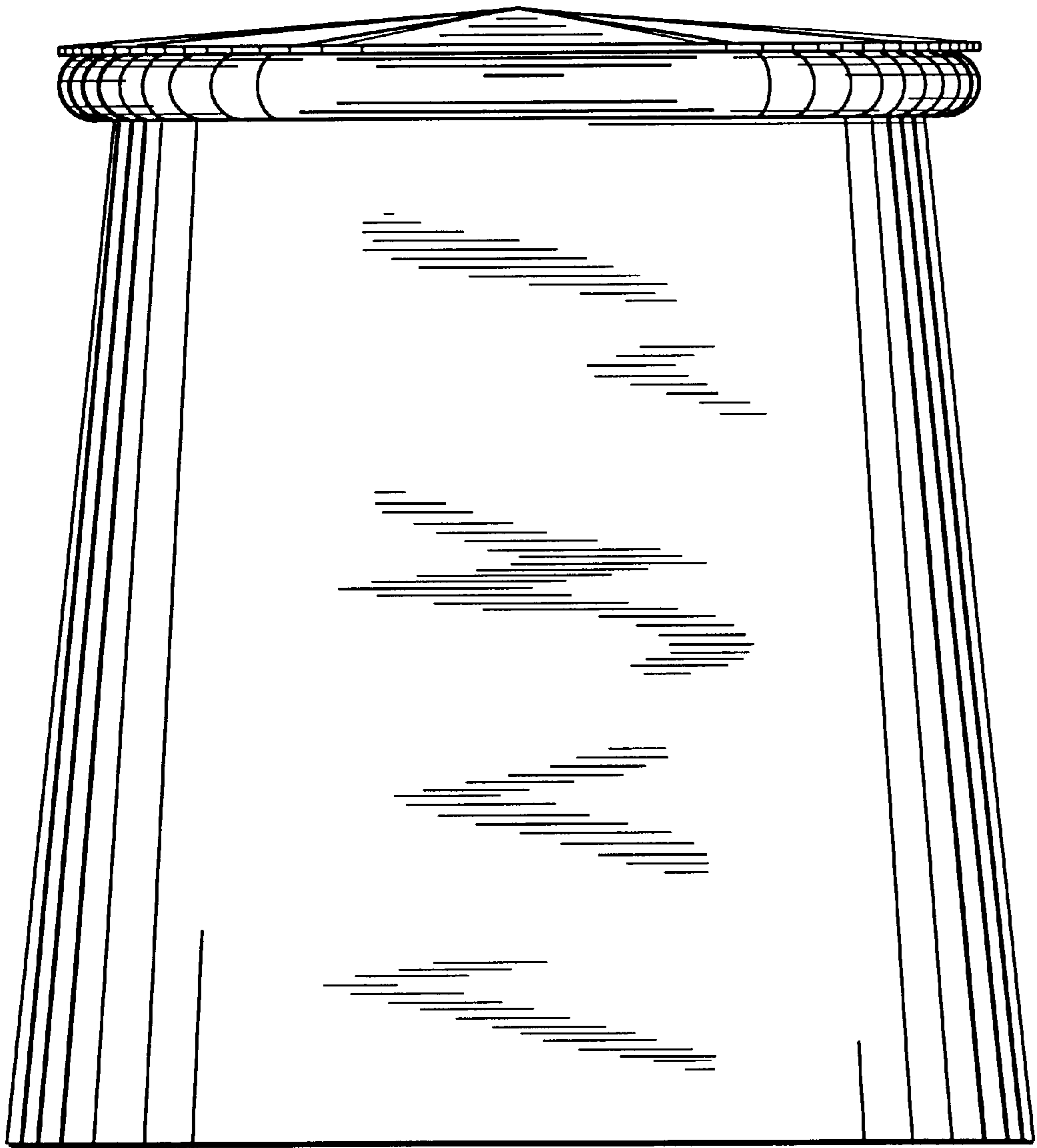

FIG. 3

FIG. 4

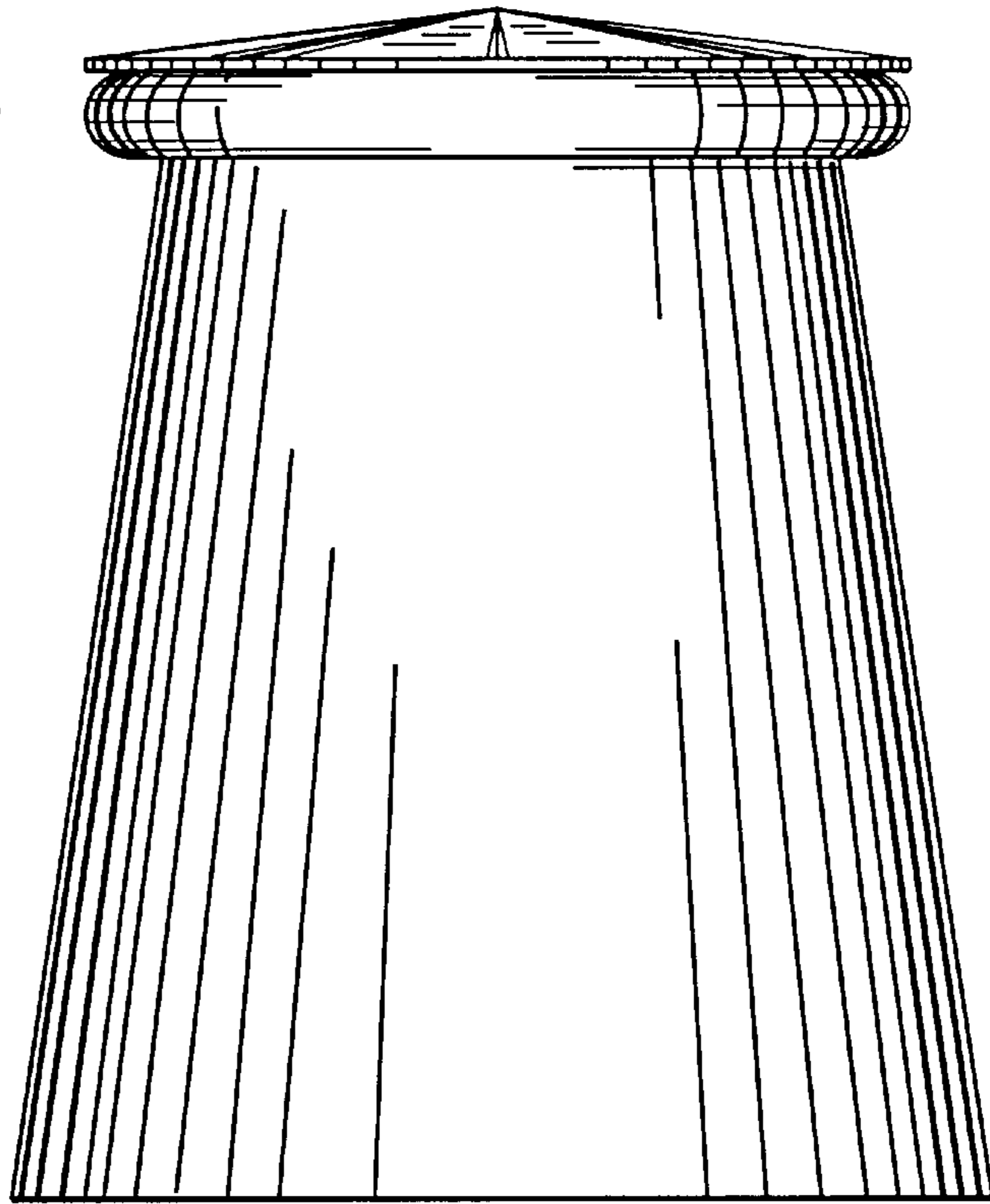

FIG. 5

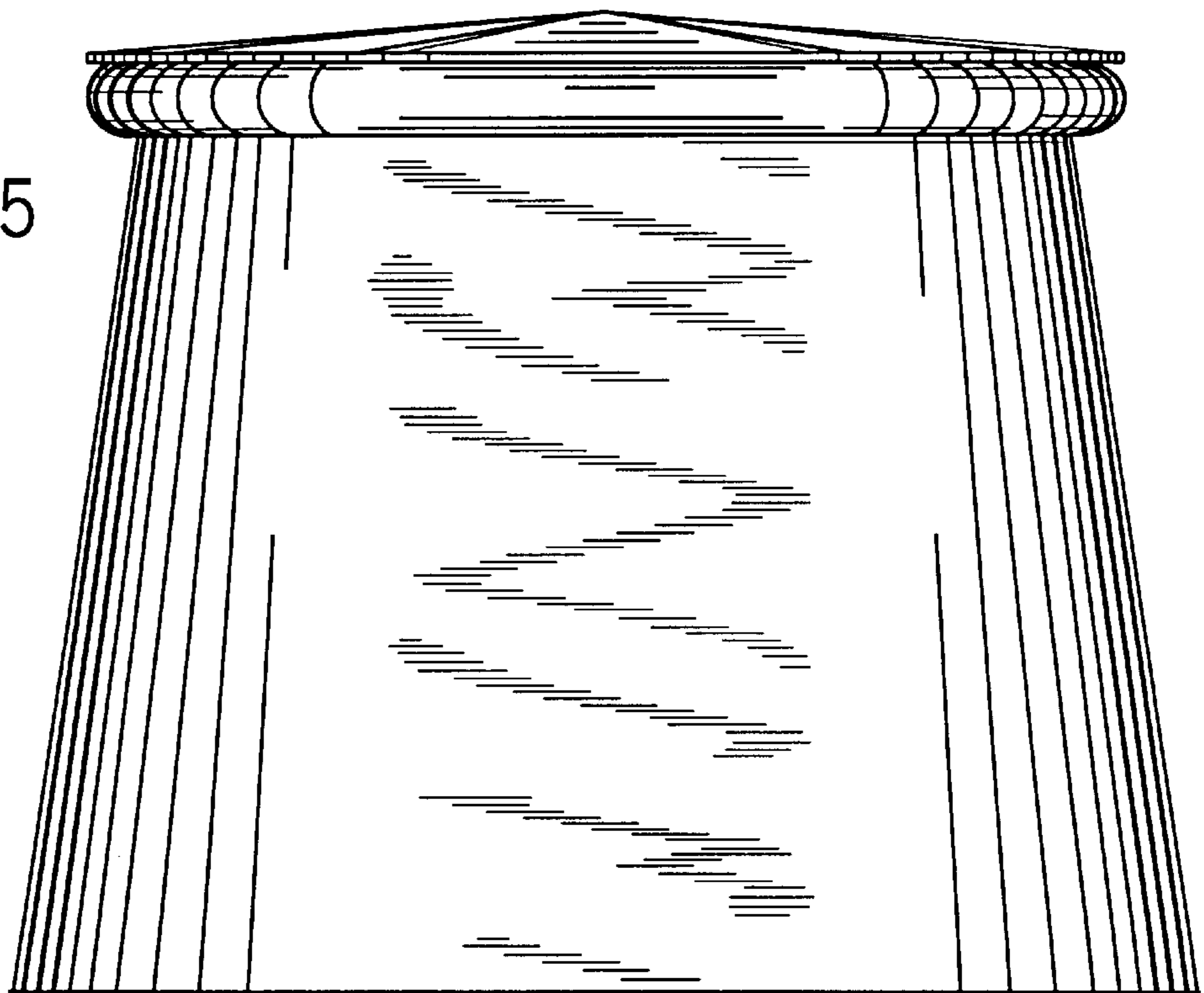

FIG. 6

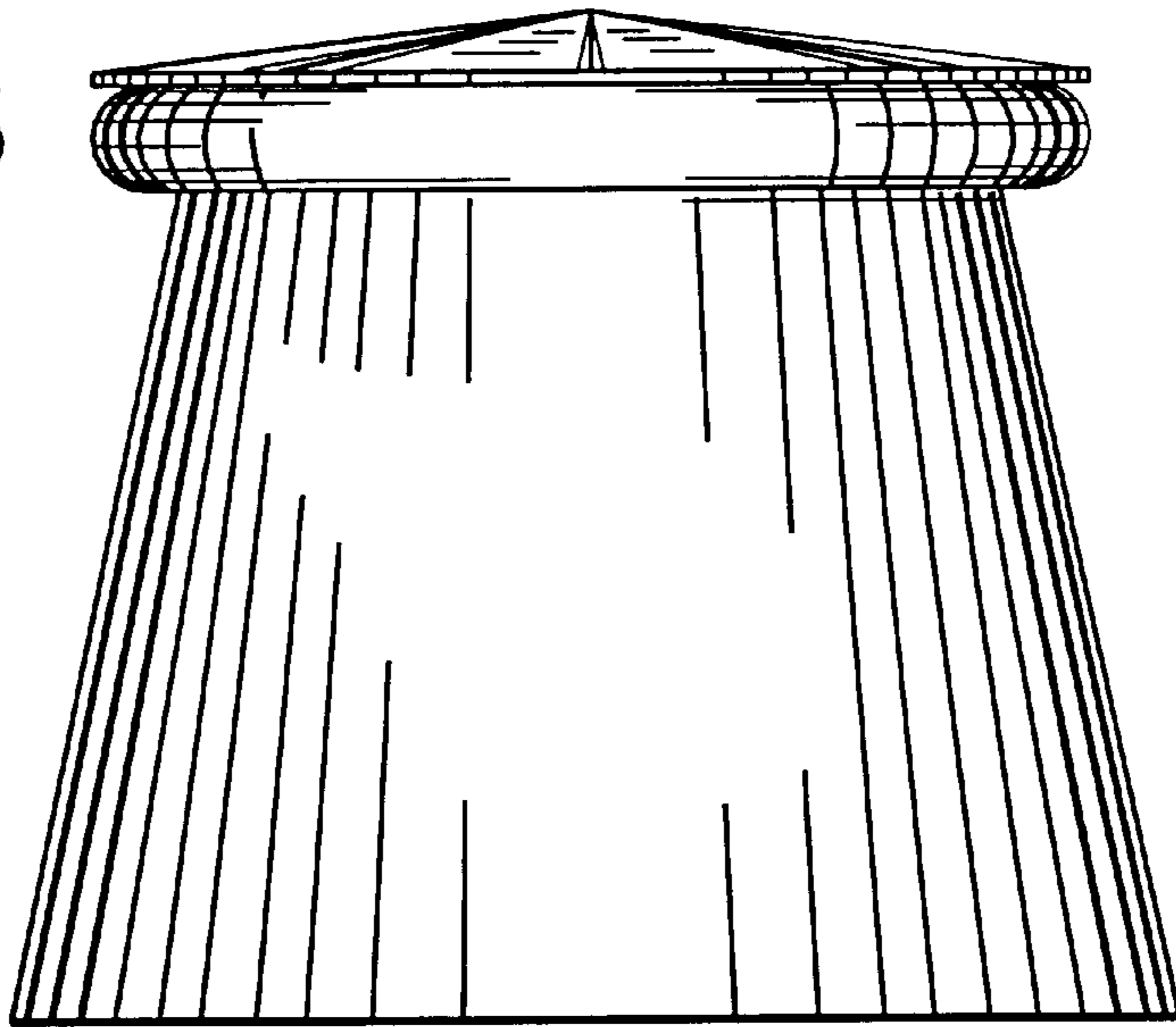

FIG. 7

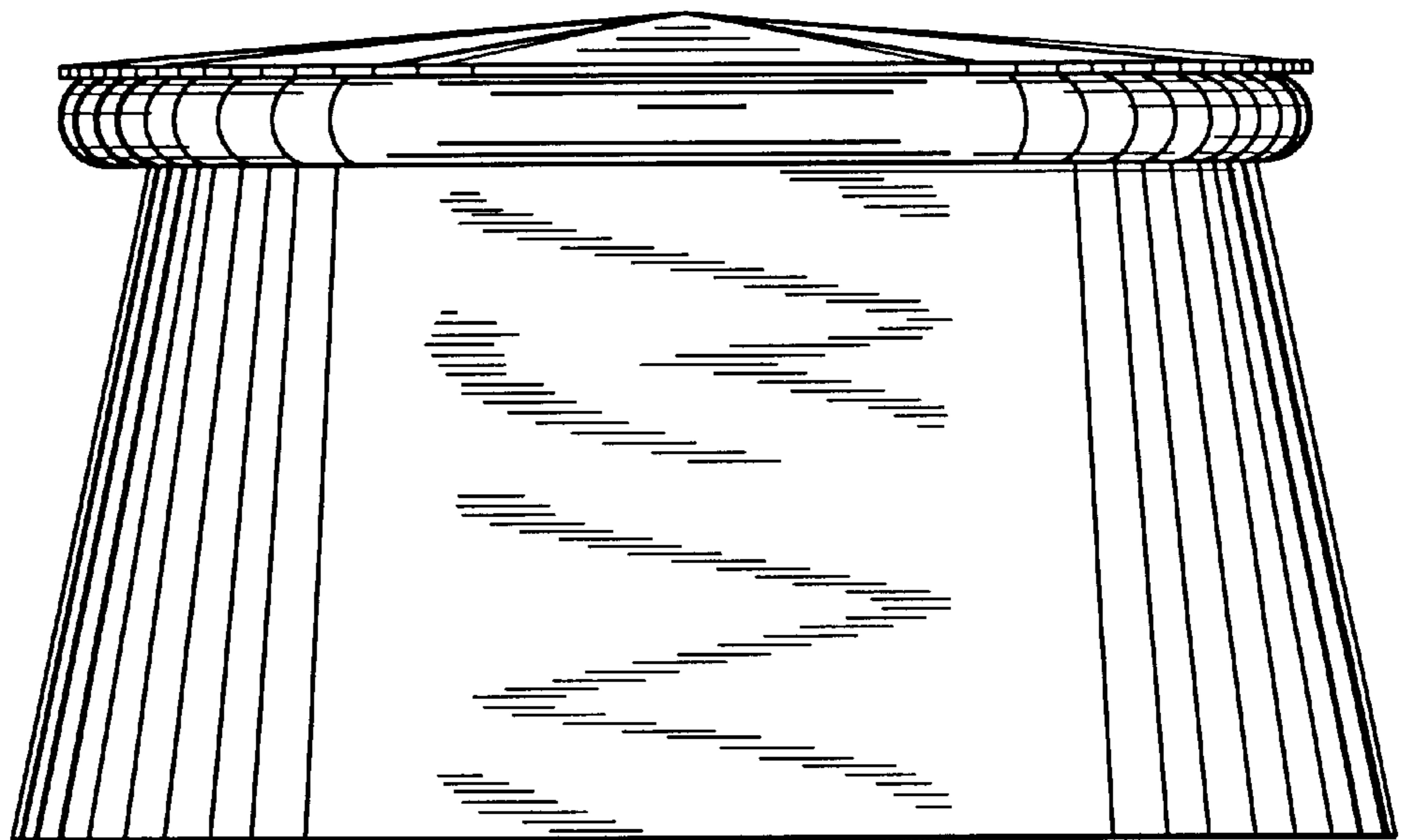

FIG. 8

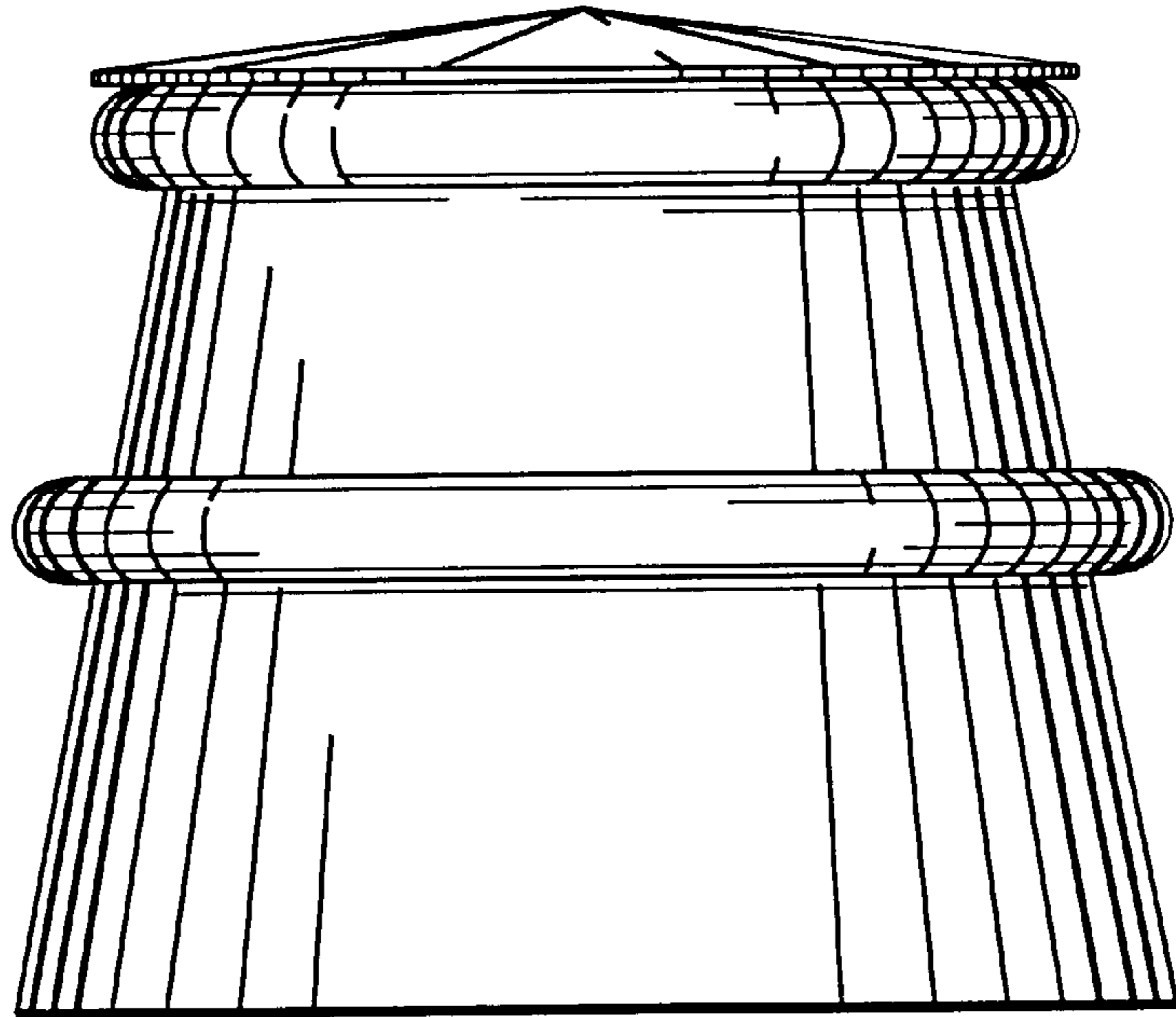

FIG. 9

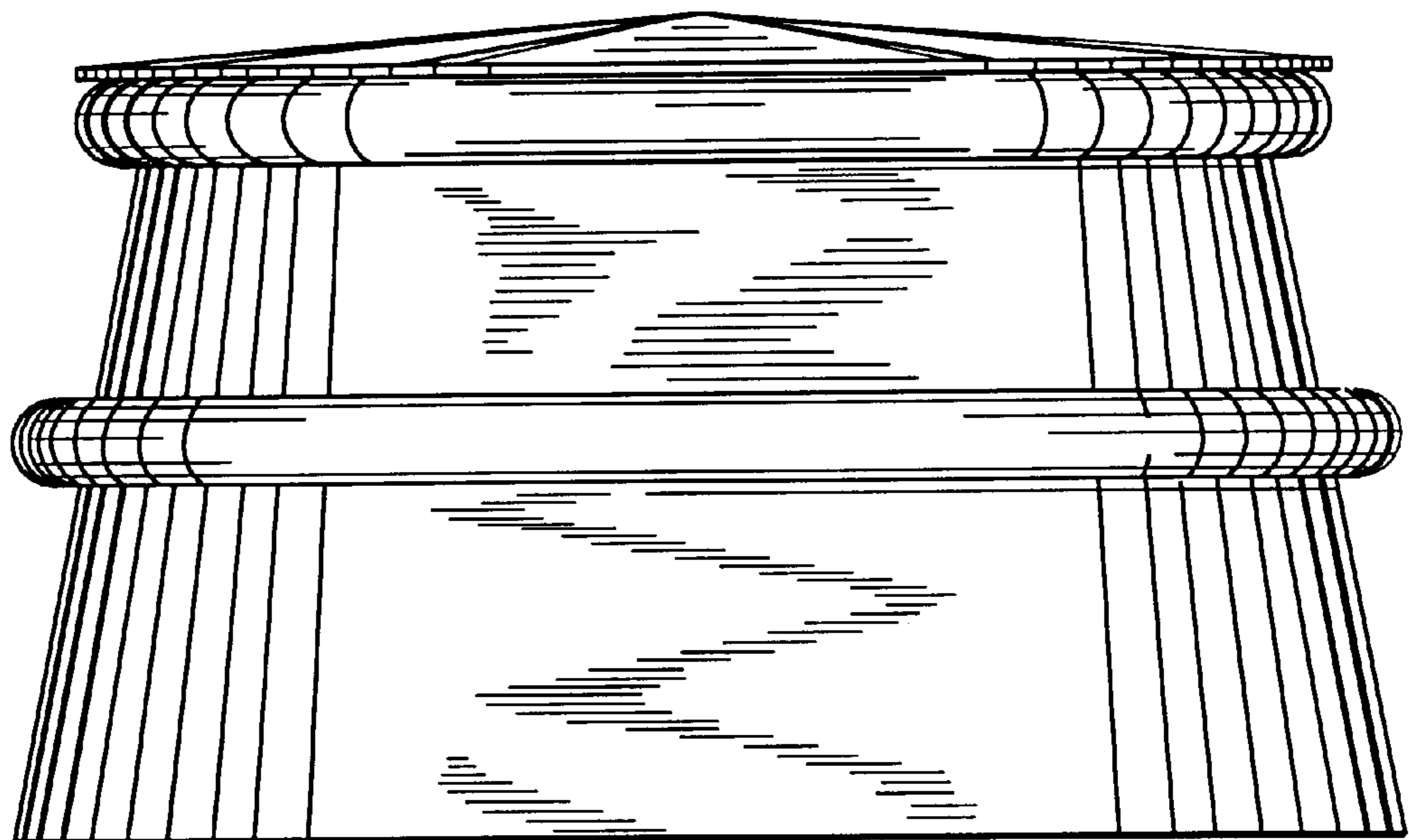

FIG. 10

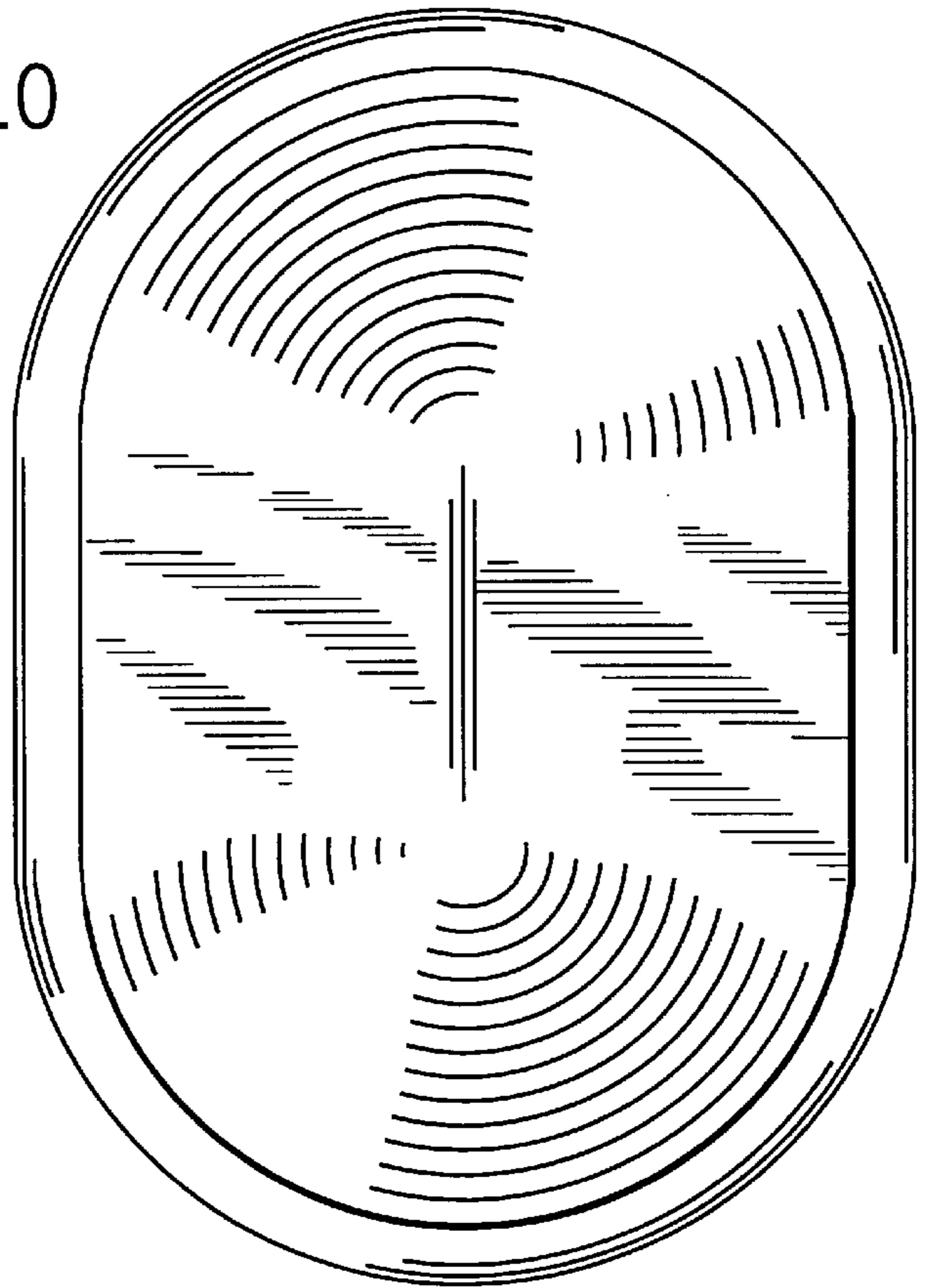
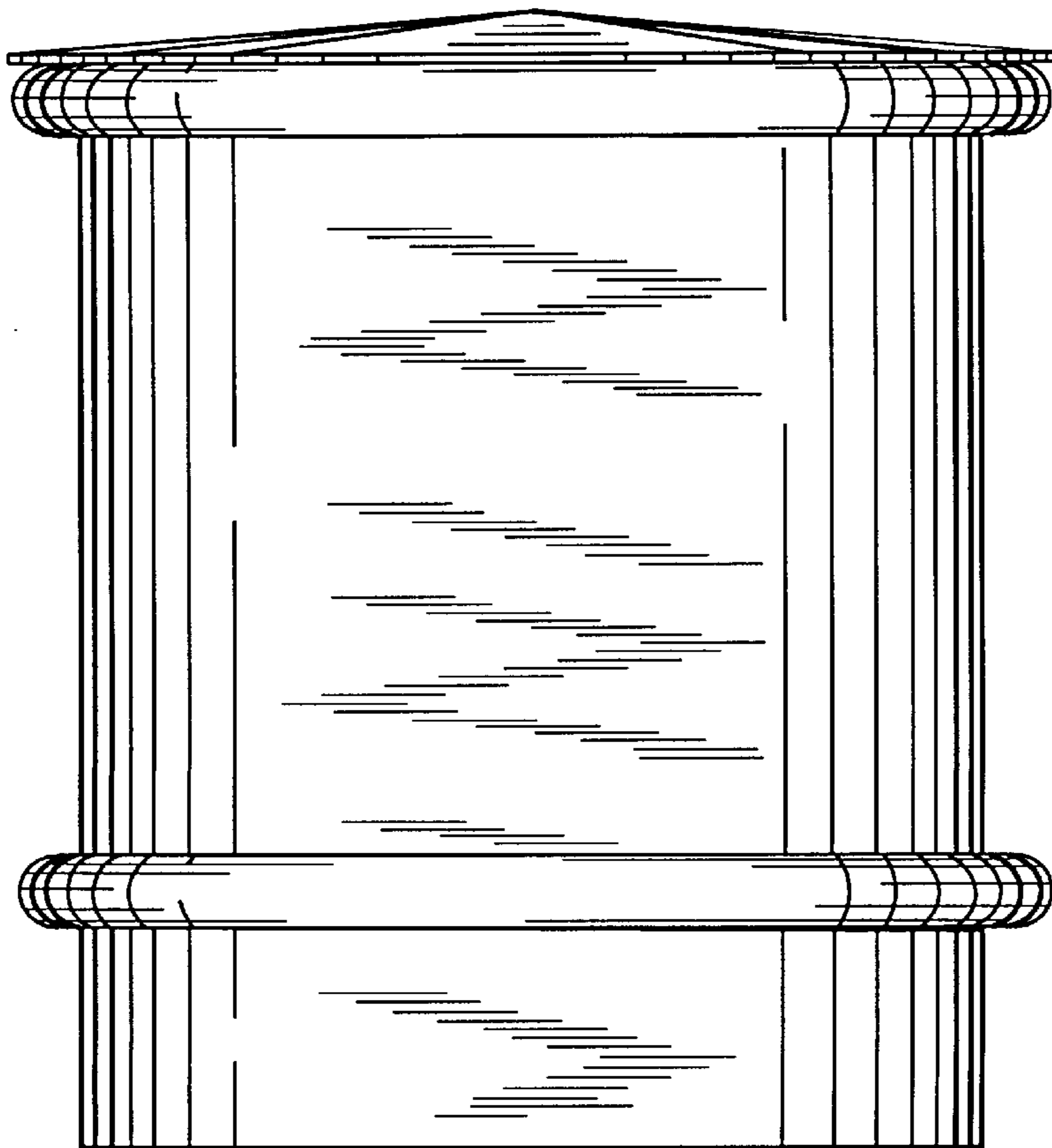

FIG. 11



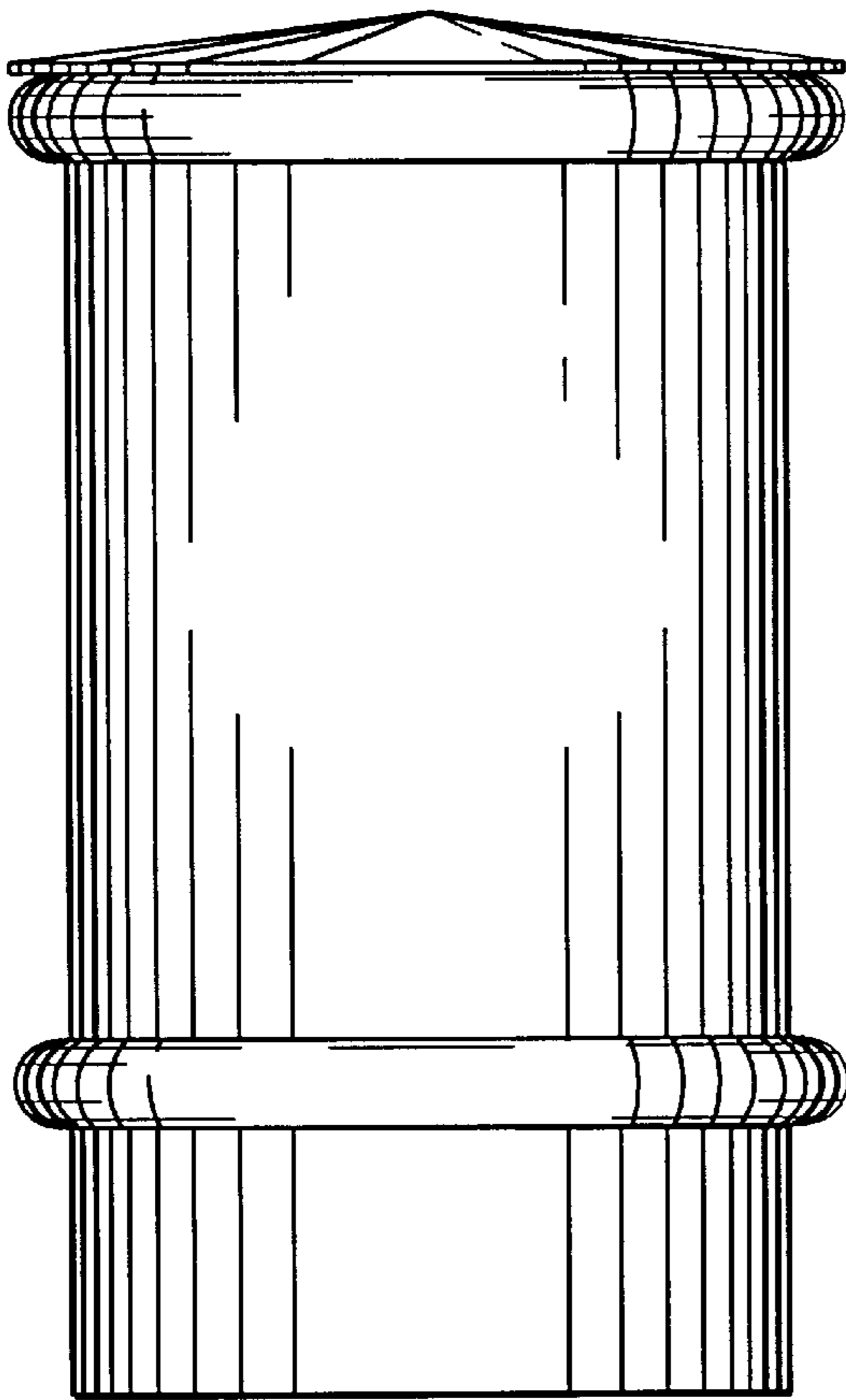

FIG. 12

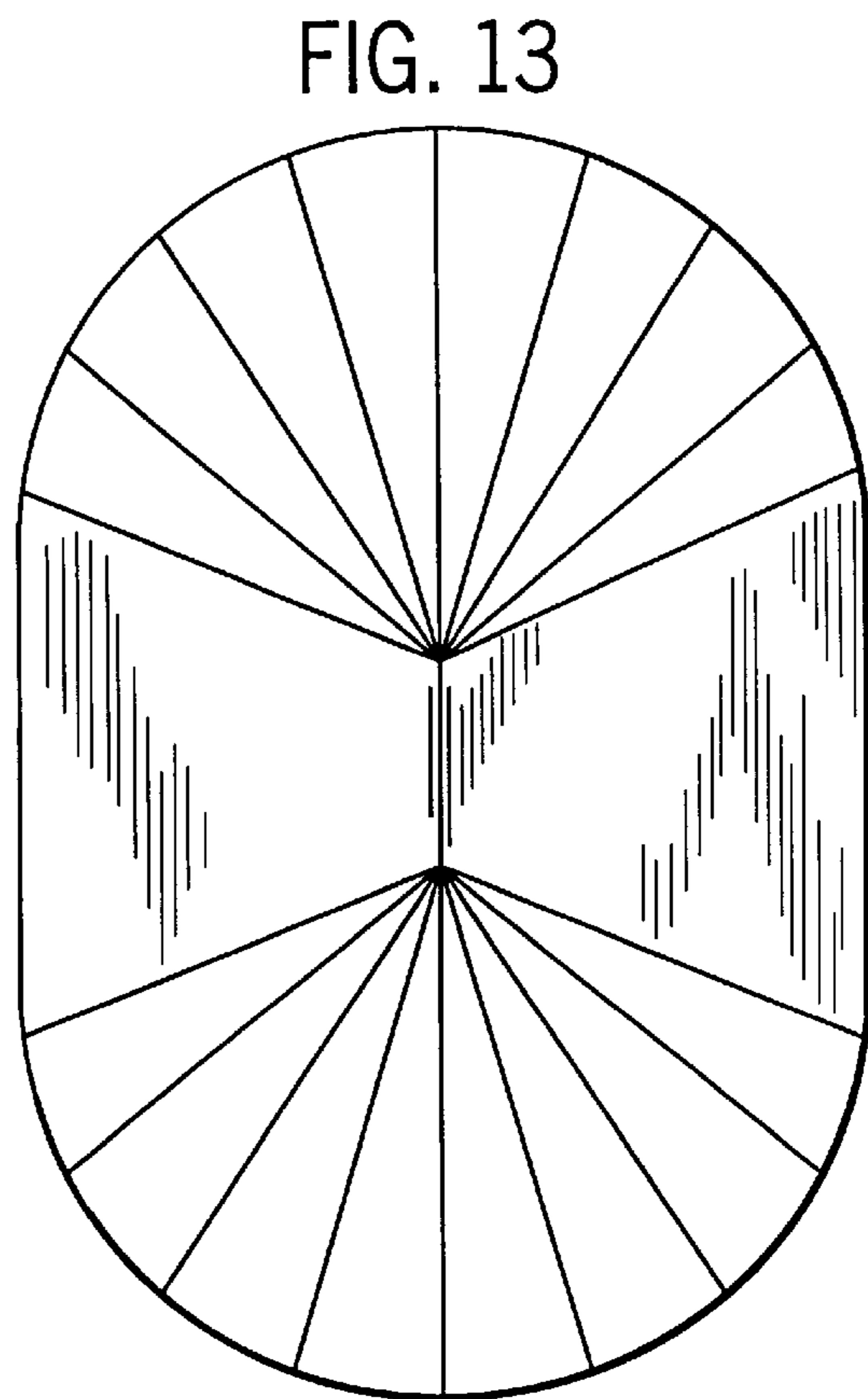

FIG. 13

FIG. 14

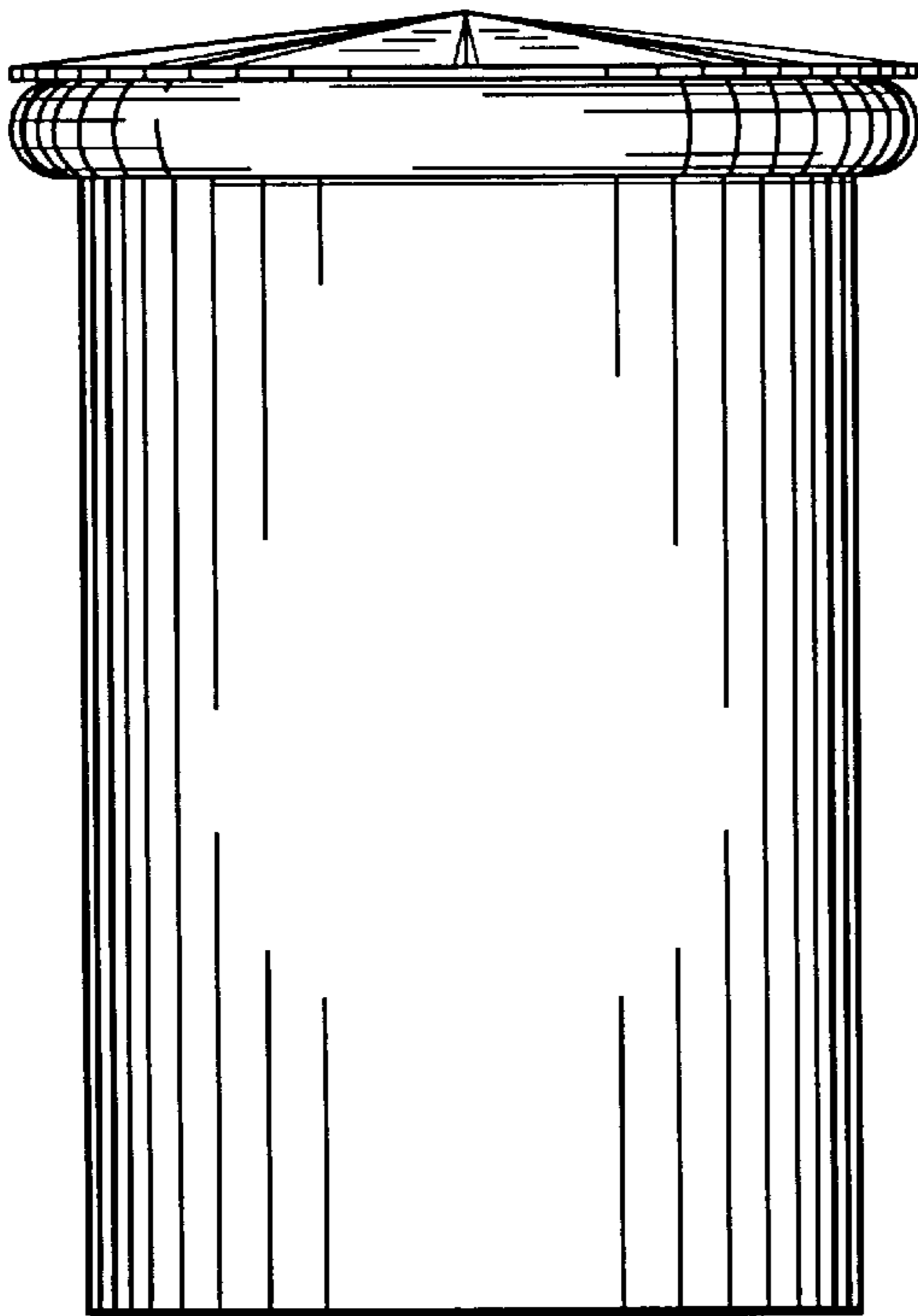

FIG. 16

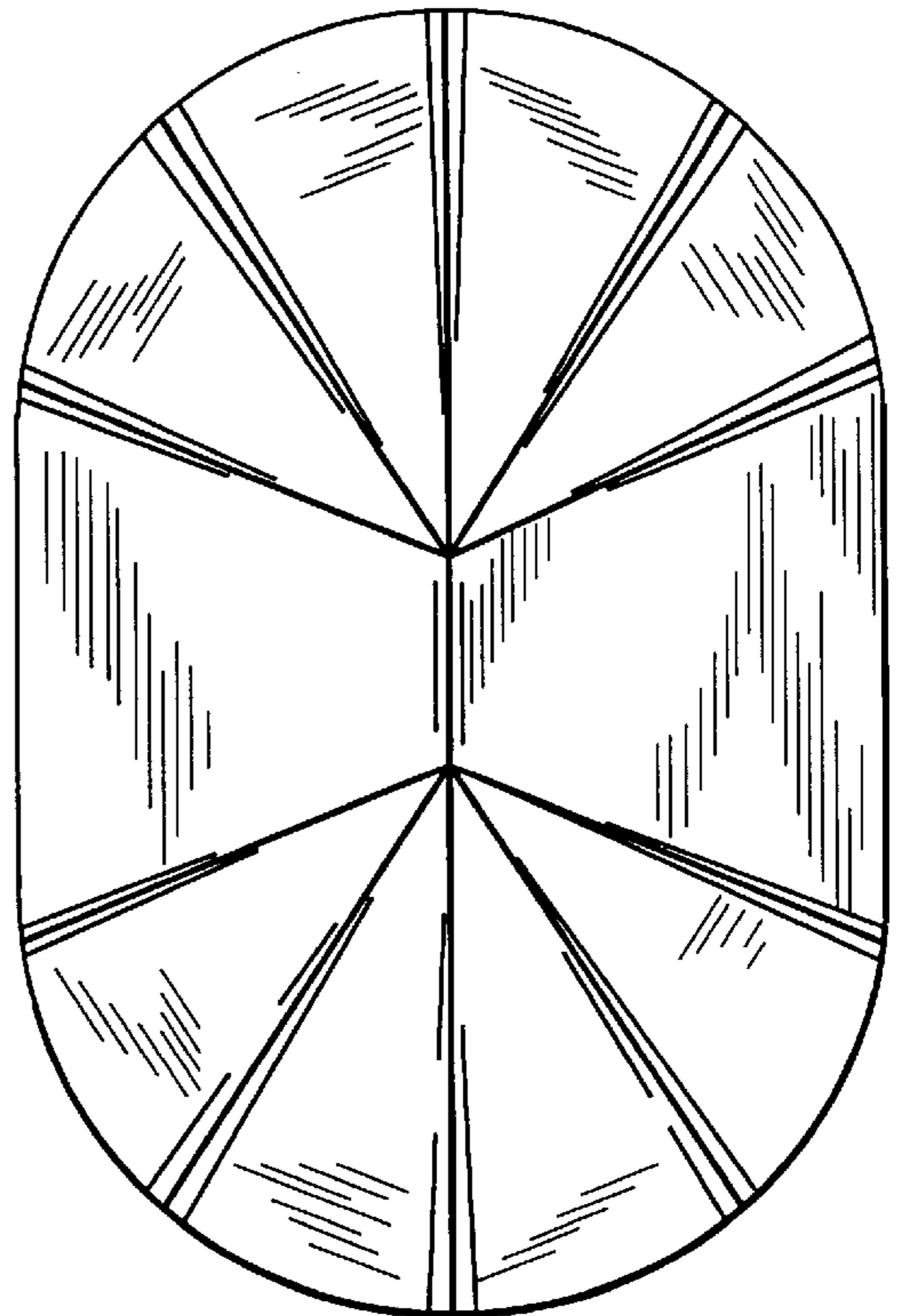

FIG. 15

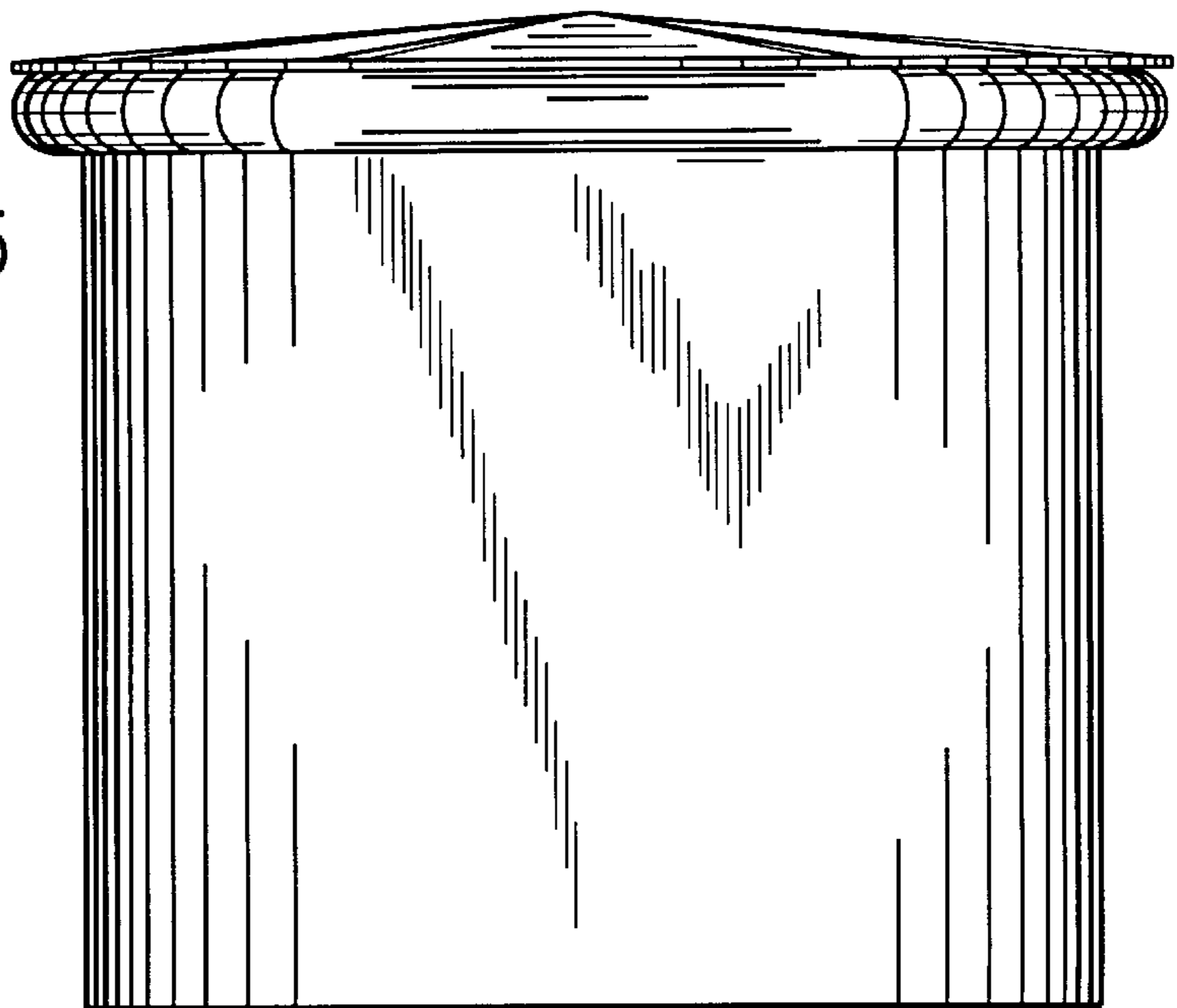

FIG. 17

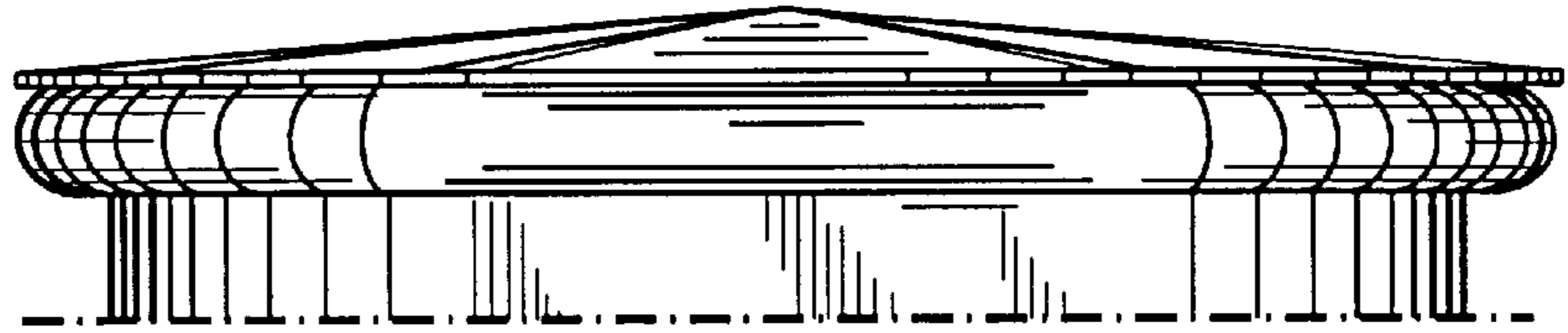

FIG. 18

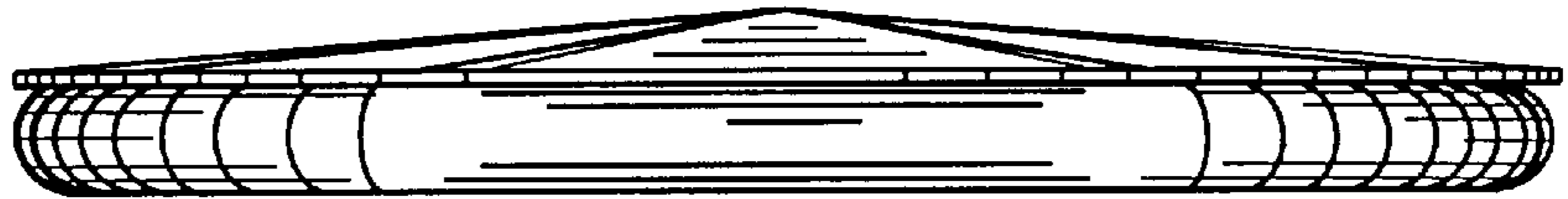

FIG. 19

