



US00D416554S

# United States Patent [19]

Sakamoto et al.

[11] **Patent Number: Des. 416,554**

[45] **Date of Patent: \*\* Nov. 16, 1999**

[54] **DIGITAL VIDEO DISC PLAYER**

D. 339,125 9/1993 Shimose et al. .... D14/135

[75] Inventors: **Satoshi Sakamoto**, Osaka; **Shinji Makino**, Nara; **Takao Yoshioka**, Osaka, all of Japan

### FOREIGN PATENT DOCUMENTS

961251 8/1996 Japan .  
964129 9/1996 Japan .  
974419 2/1997 Japan .

[73] Assignee: **Matsushita Electric Industrial Co., Ltd.**, Japan

*Primary Examiner*—Ted Shooman  
*Assistant Examiner*—Richelle Shelton  
*Attorney, Agent, or Firm*—SAIDMAN DesignLaw Group

[\*\*] Term: **14 Years**

[21] Appl. No.: **29/101,071**

### [57] CLAIM

[22] Filed: **Feb. 25, 1999**

The ornamental design for a digital video disc player, as shown and described.

### [30] Foreign Application Priority Data

### DESCRIPTION

Sep. 2, 1998 [JP] Japan ..... 10-25214

[51] **LOC (6) Cl.** ..... **14-01**

[52] **U.S. Cl.** ..... **D14/136**

[58] **Field of Search** ..... D14/124, 135,  
D14/136, 156, 160, 239; 386/125, 126;  
369/75.1, 77.1

FIG. 1 is a perspective view of the top, front and right side of a digital video disc player showing our new design; FIG. 2 is a front view thereof; FIG. 3 is a rear view thereof; FIG. 4 is a top plan view thereof; FIG. 5 is a right side view thereof; FIG. 6 is a left side view thereof; and, FIG. 7 is a bottom view thereof.

### [56] References Cited

#### U.S. PATENT DOCUMENTS

D. 327,058 6/1992 Maeyama ..... D14/135

**1 Claim, 5 Drawing Sheets**

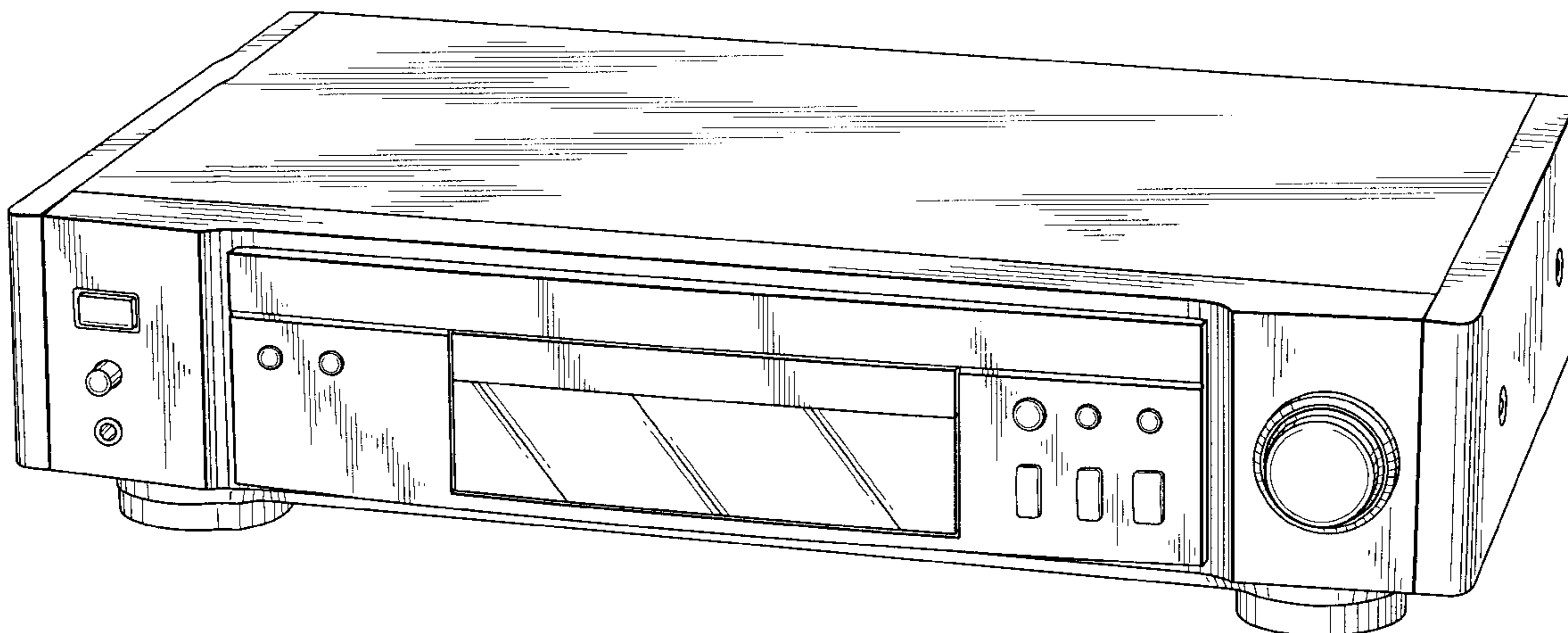

FIG. 1

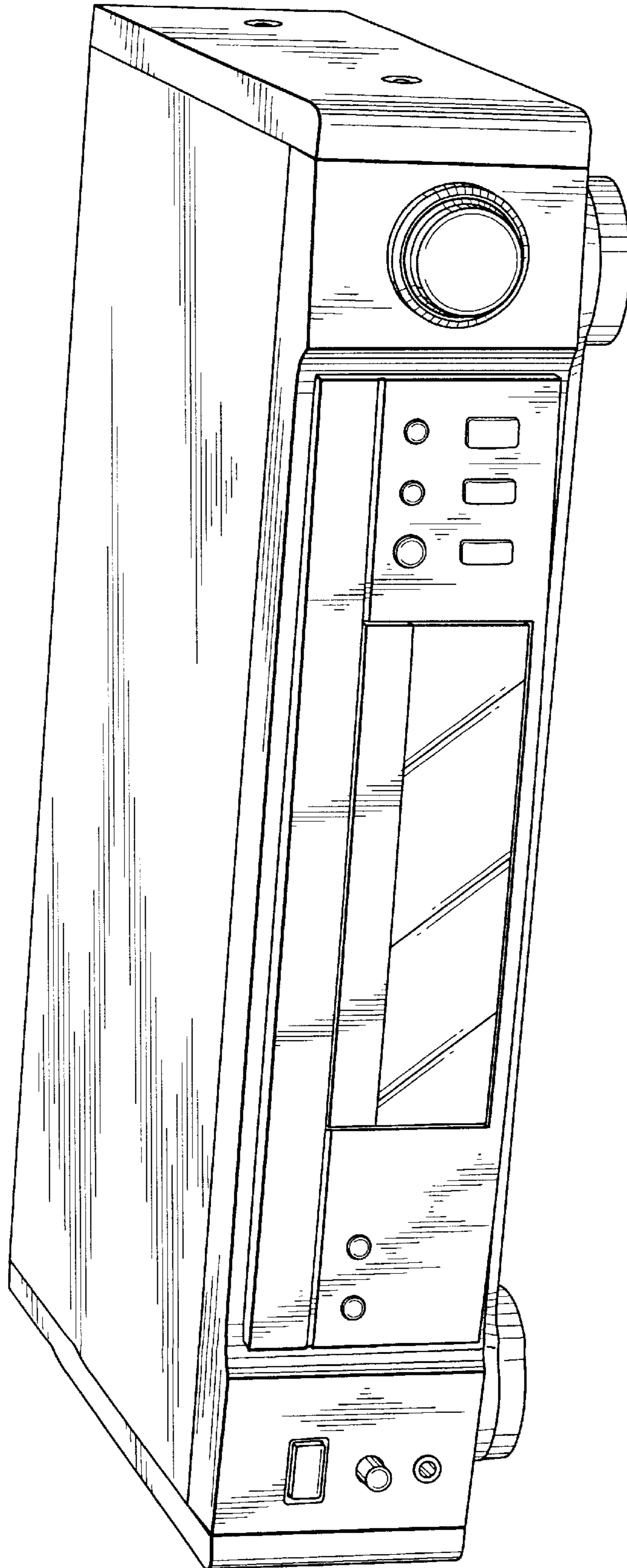

FIG. 2

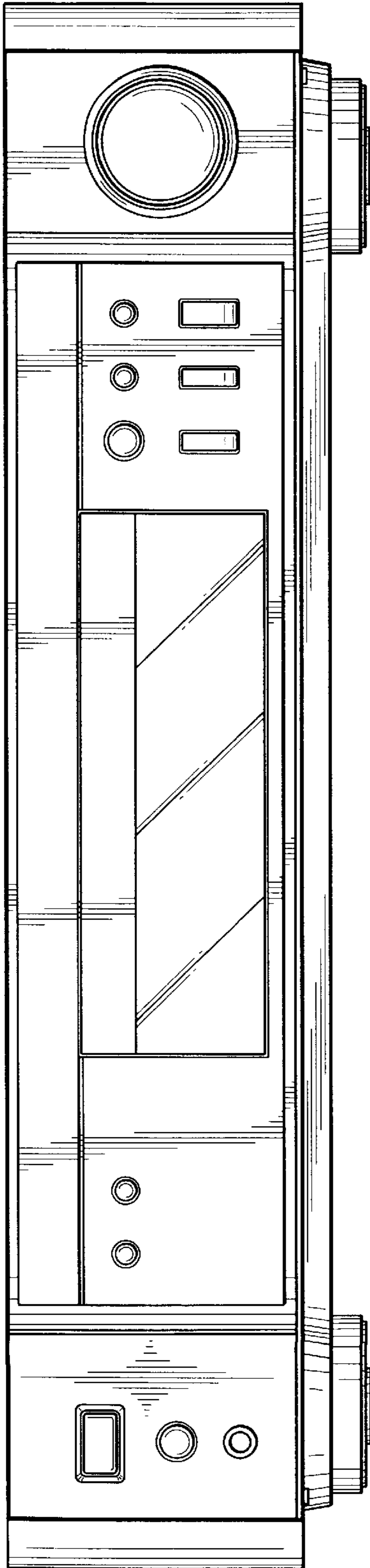

FIG. 3

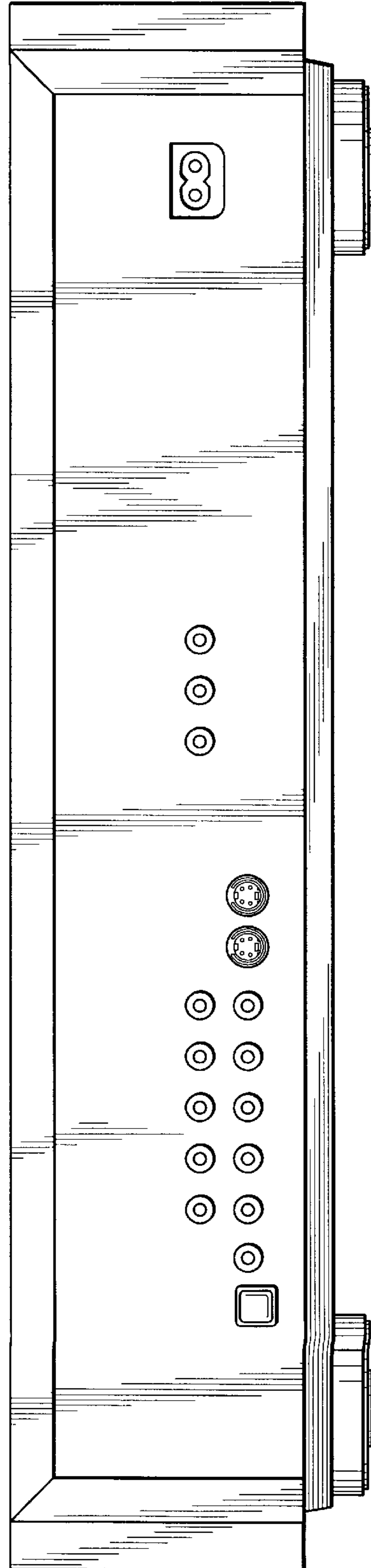
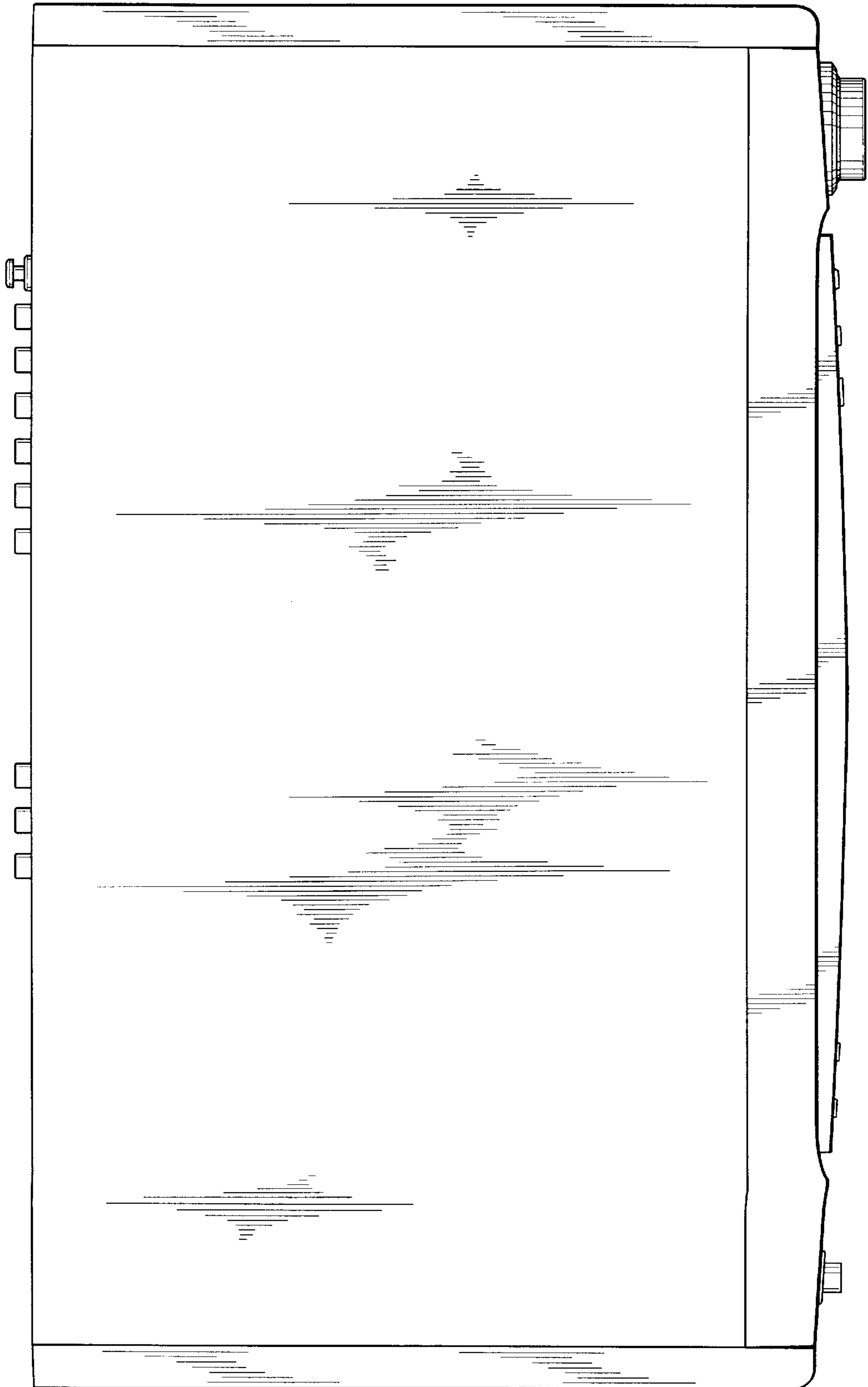
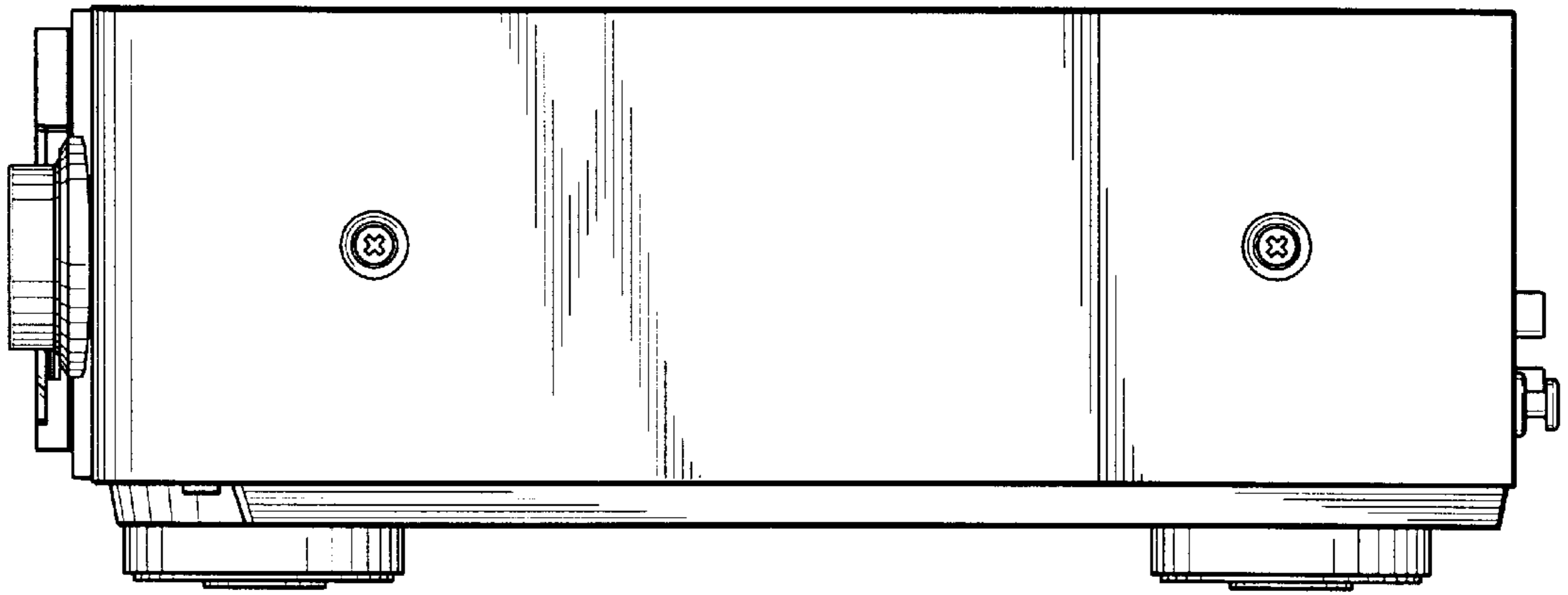

FIG. 4



*FIG. 5*



*FIG. 6*

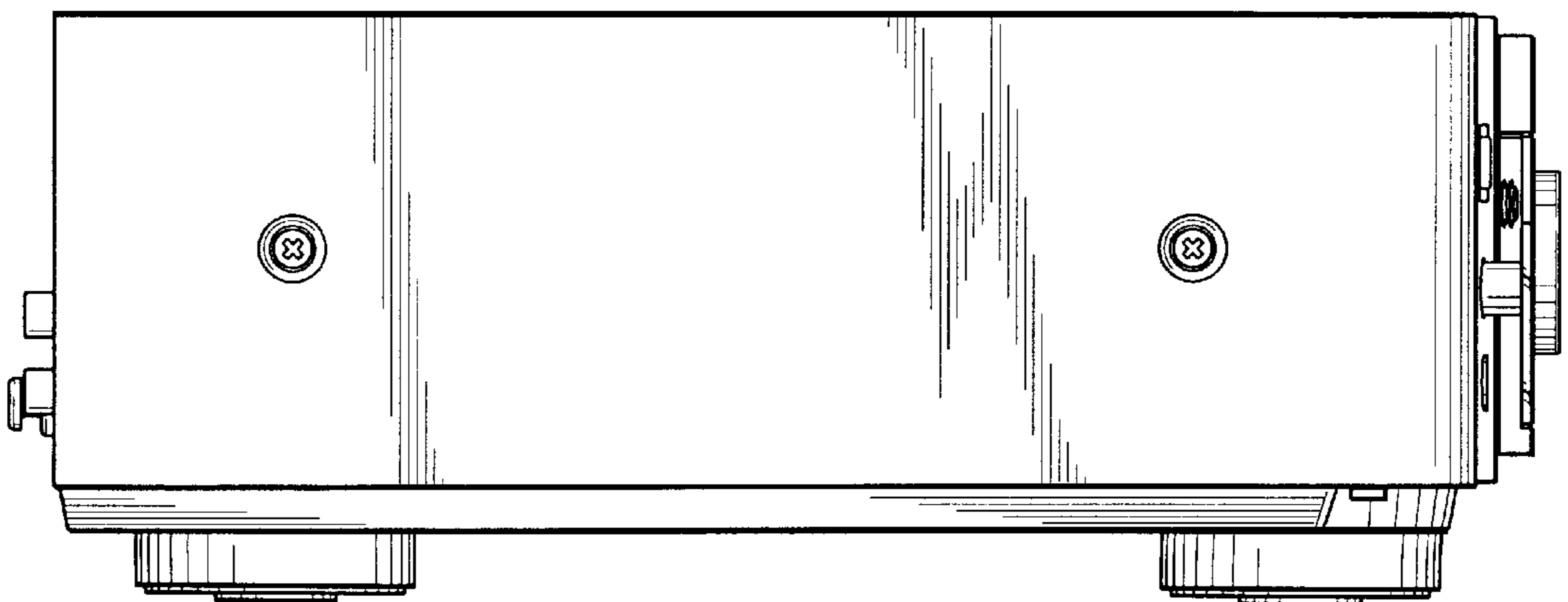

FIG. 7

