



US00D416383S

United States Patent [19] Downing

[11] Patent Number: Des. 416,383

[45] Date of Patent: ** Nov. 16, 1999

[54] DECORATIVE PENCIL HOLDER

5,441,149 8/1995 Willard et al. 206/214

[76] Inventor: **Herbert B. Downing**, P.O. Box 19382,
Philadelphia, Pa. 19143

Primary Examiner—B. J. Bullock
Assistant Examiner—Monica A. Weingart
Attorney, Agent, or Firm—David L. Volk

[**] Term: **14 Years**

[57] CLAIM

[21] Appl. No.: **29/097,277**

The ornamental design for a decorative pencil holder, as shown and described.

[22] Filed: **Dec. 3, 1998**

DESCRIPTION

[51] LOC (6) Cl. **03-01**

[52] U.S. Cl. **D3/206; D3/201; D21/511; D25/33; D25/34**

[58] Field of Search D3/201, 206; D19/75, D19/77, 80, 81, 82, 84, 85; 206/214; D21/506, 507, 511; D25/34, 33, 59; 52/79.4, 79.7, 79.8; D11/157

FIG. 1 is a perspective view of a decorative pencil holder showing my new design;
FIG. 2 is a perspective view thereof, shown without the environmental structure;
FIG. 3 is a right side elevational view thereof;
FIG. 4 is a left side elevational view thereof;
FIG. 5 is a front elevational view thereof;
FIG. 6 is a rear elevational view thereof;
FIG. 7 is a top plan view thereof; and,
FIG. 8 is a bottom plan view thereof.

[56] References Cited

U.S. PATENT DOCUMENTS

D. 155,836	11/1949	Pfleger	D21/511	X
D. 348,080	6/1994	Popovits	D19/82	
D. 354,311	1/1995	Tarozzi	D19/82	
D. 380,247	6/1997	Morris	D21/507	
769,616	9/1904	Kraus	D19/85	
992,337	5/1911	Butler	D21/511	X

The dotted line showing of the pencils in FIG. 1 shows environmental structure which does not form a part of the claimed design.

1 Claim, 5 Drawing Sheets

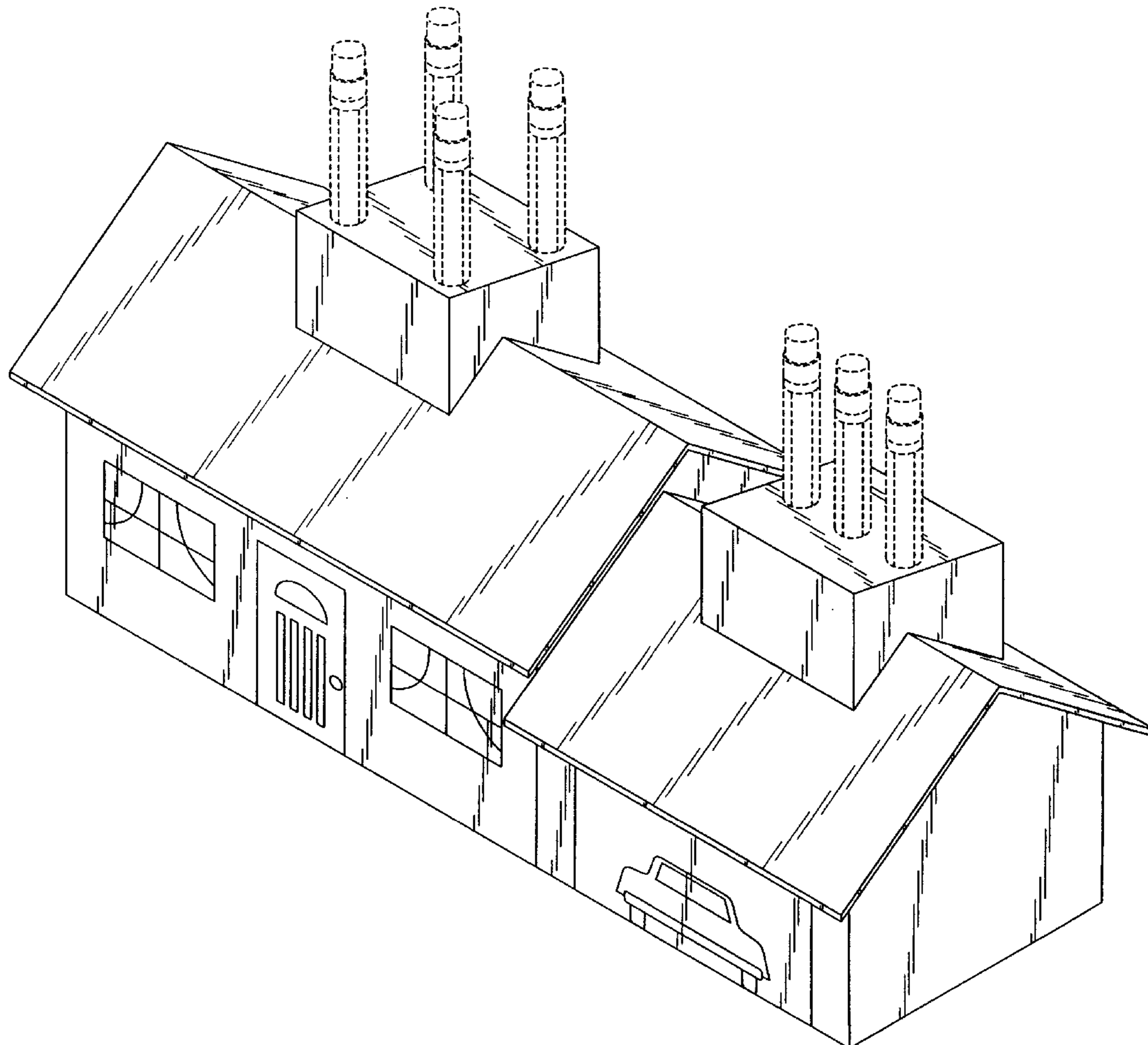

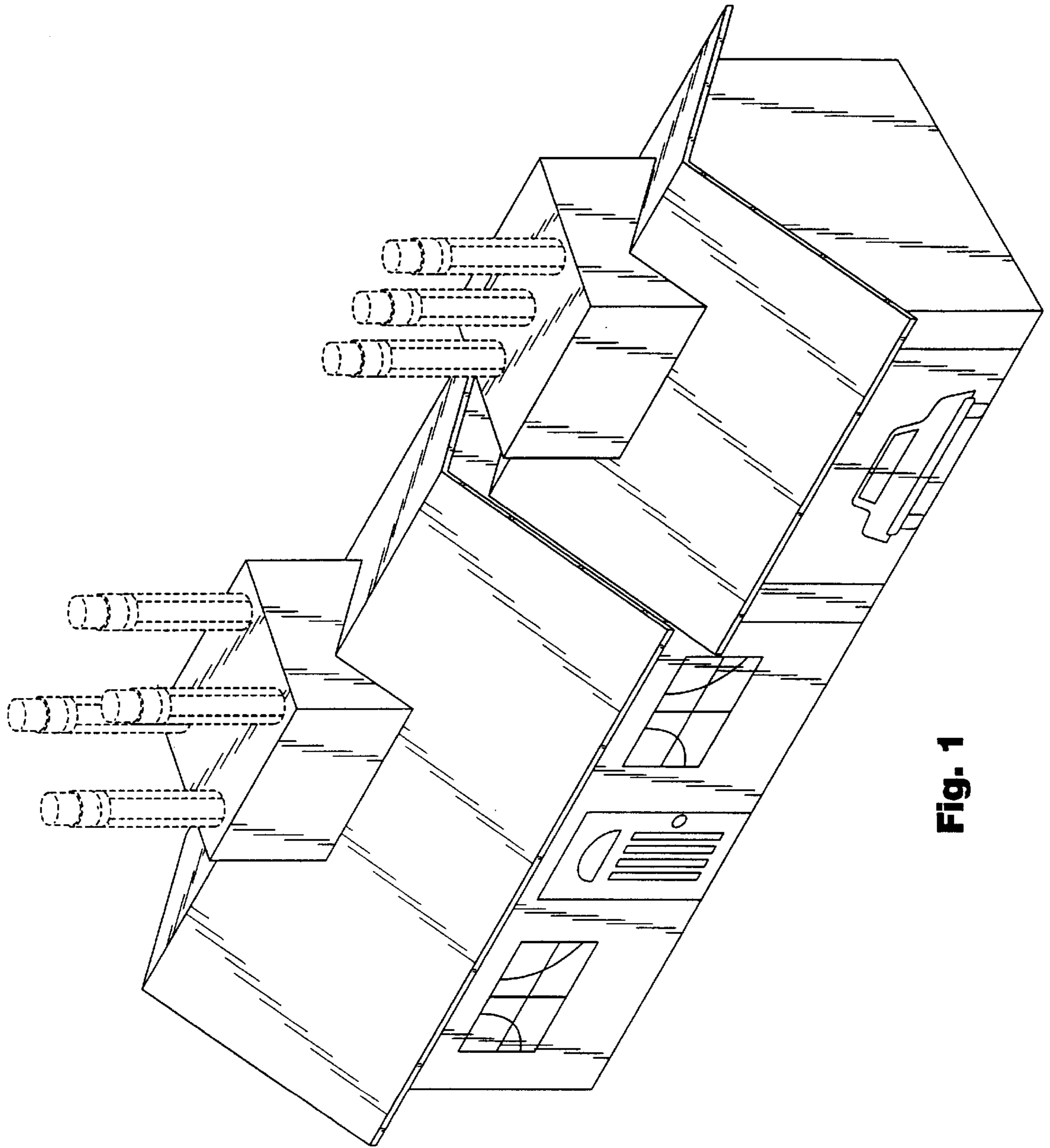

Fig. 1

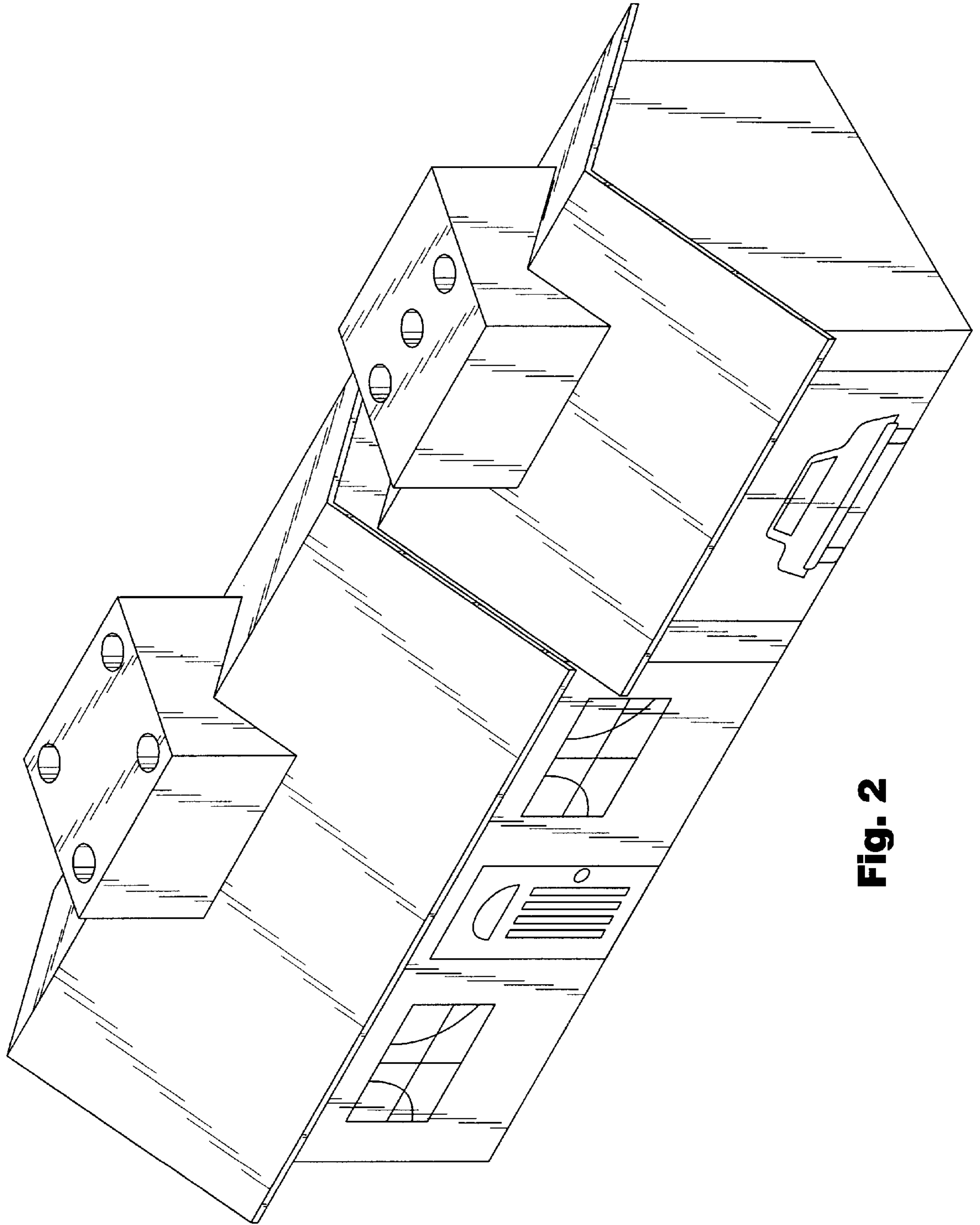

Fig. 2

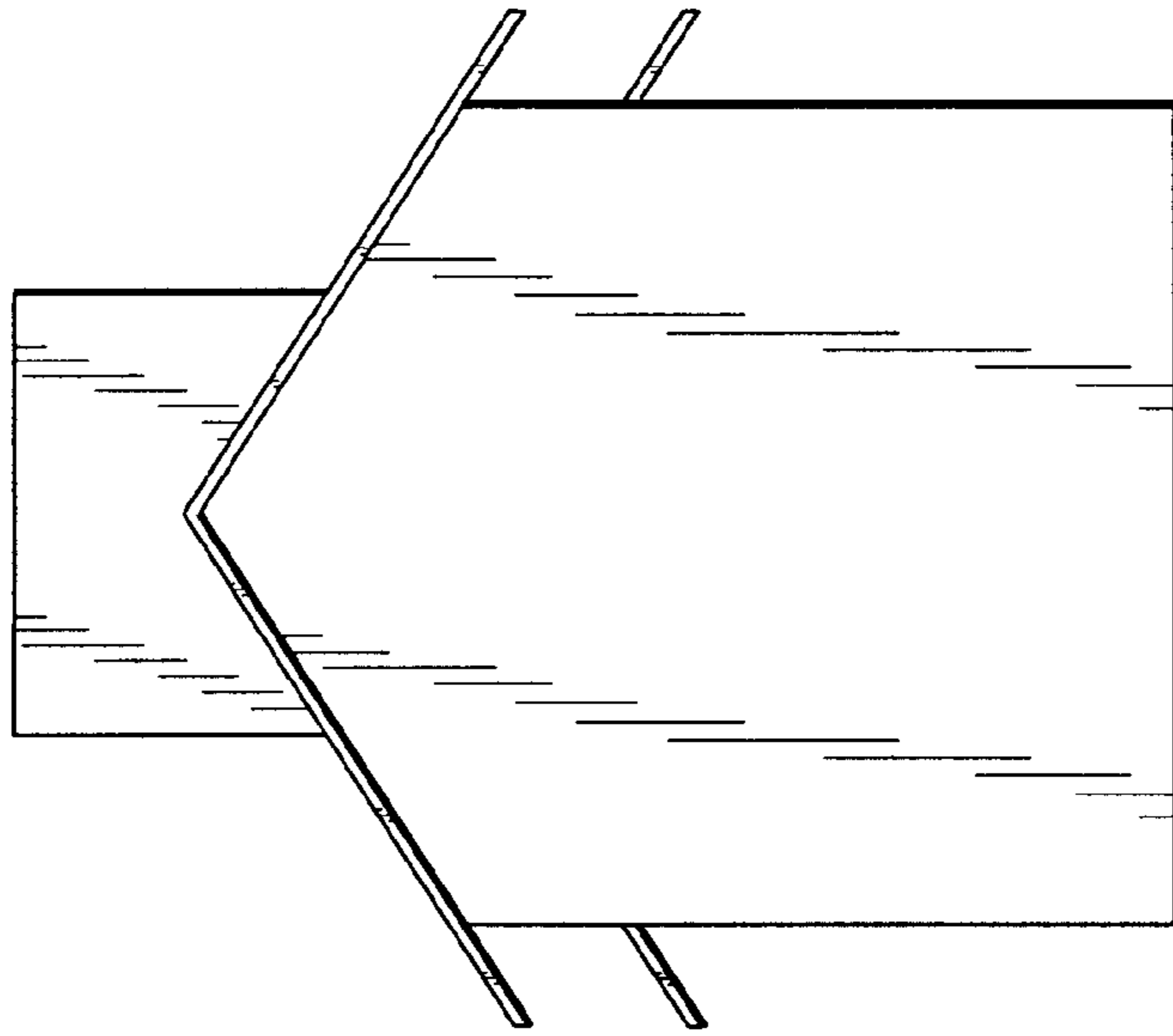

Fig. 4

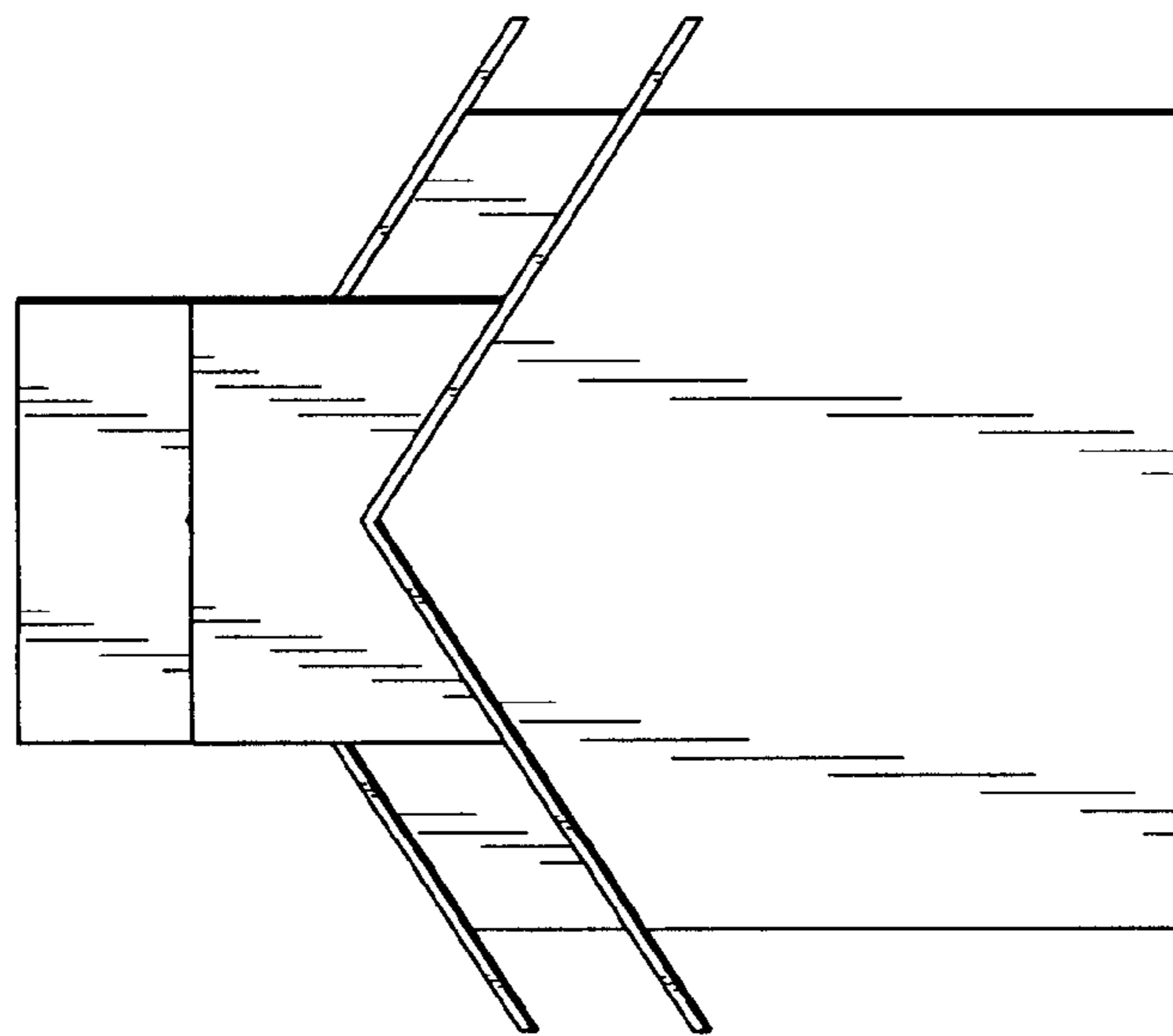

Fig. 3

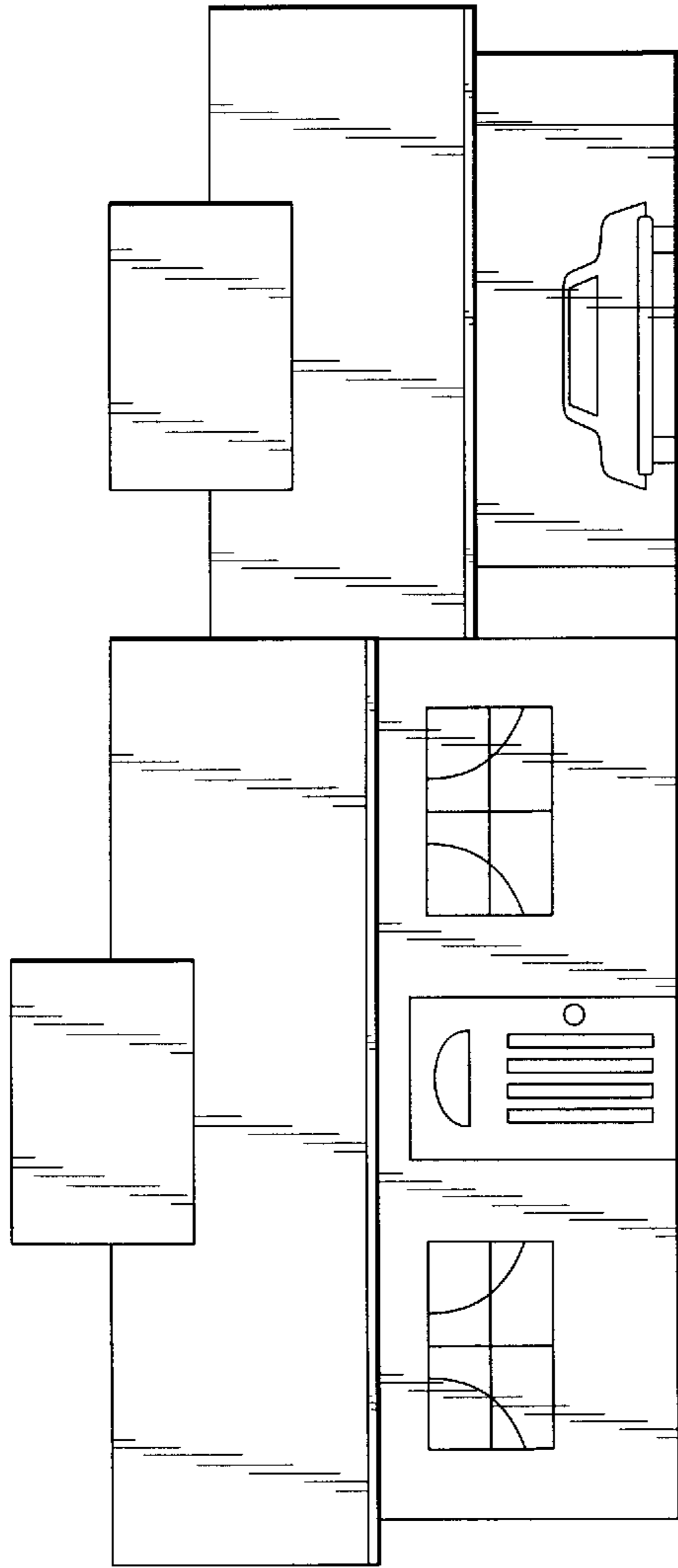

Fig. 5

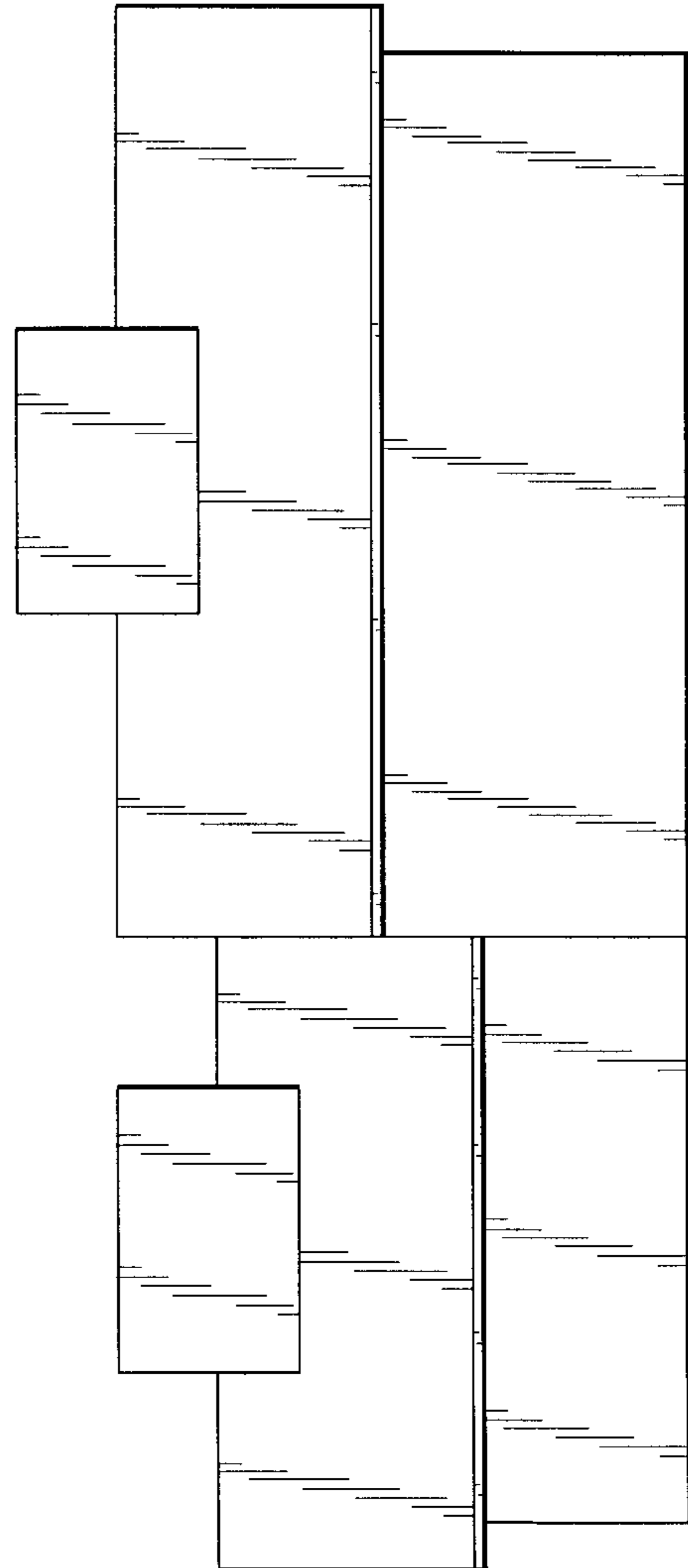

Fig. 6

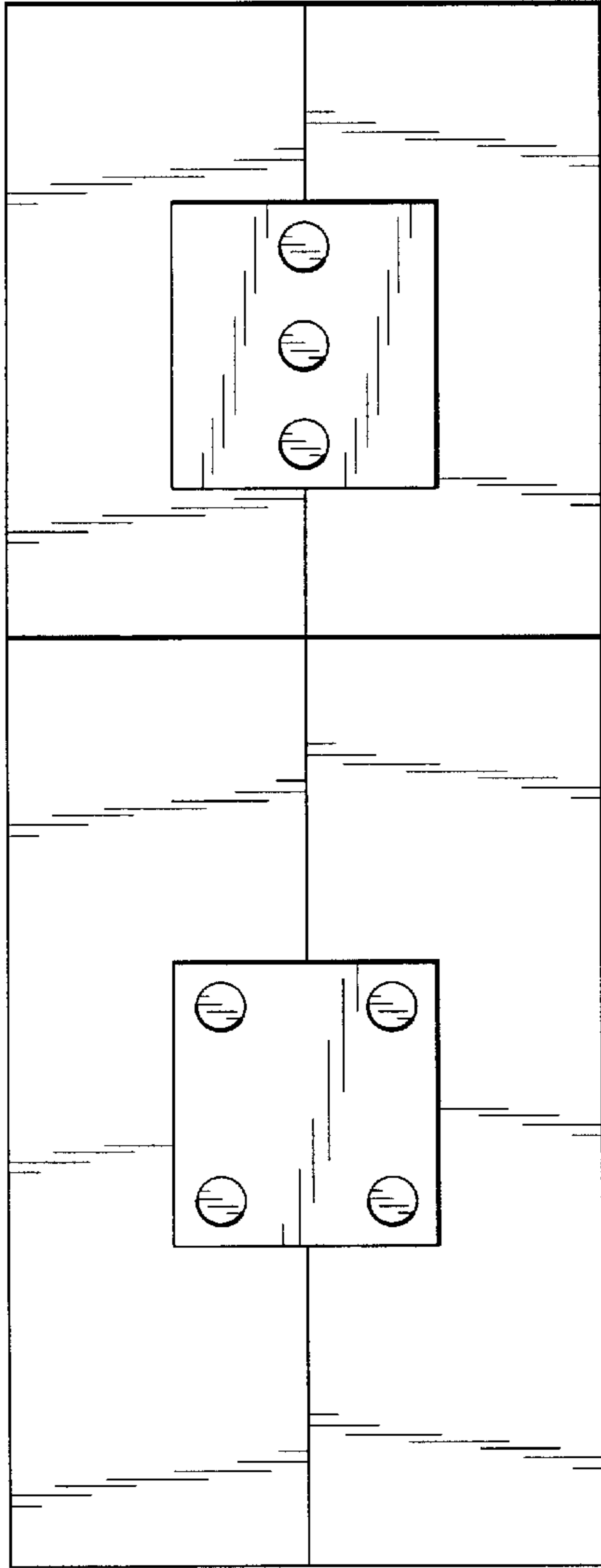

Fig. 7

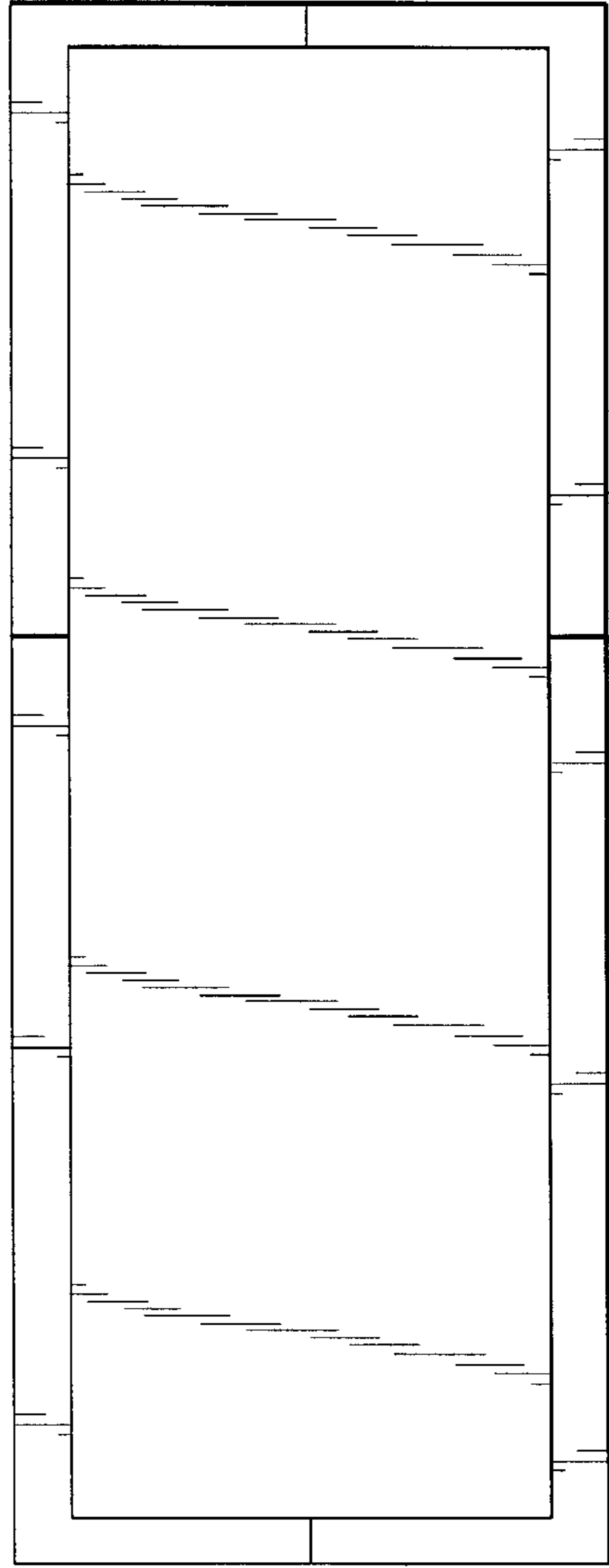

Fig. 8