



US00D416336S

United States Patent [19]

Turner et al.

[11] **Patent Number: Des. 416,336**

[45] **Date of Patent: ** Nov. 9, 1999**

[54] **FLOOR PLANK PROTECTIVE CAP**

[76] Inventors: **Laurence A Turner; Lynda Turner,**
both of 224 Elm St., Delavan, Wis.
53115

[**] Term: **14 Years**

[21] Appl. No.: **29/095,150**

[22] Filed: **Oct. 15, 1998**

[51] **LOC (6) Cl. 25-01**

[52] **U.S. Cl. D25/135**

[58] **Field of Search 52/800.12, 801.1,**
52/716.6, 716.1, 716.8; D25/121, 135

[56] **References Cited**

U.S. PATENT DOCUMENTS

D. 270,479	9/1983	Braswell	D25/121
D. 382,984	8/1997	Junell	D25/135
1,272,826	7/1918	MacDonald	52/800.12
3,040,388	6/1962	Conn	52/800.2
4,443,508	4/1984	Mehl	52/716.8
4,995,323	2/1991	Kellems et al.	211/135

Primary Examiner—Doris Clark

[57] **CLAIM**

The ornamental design for a floor plank protective cap, as shown and described.

DESCRIPTION

FIG. 1 is a front elevational view of the floor plank protective cap of the present invention;
 FIG. 2 is a back elevational view of the floor plank protective cap of FIG. 1;
 FIG. 3 is a left side elevational view of the floor plank protective cap of FIG. 1;
 FIG. 4 is a right side elevational view of the floor plank protective cap of FIG. 1;
 FIG. 5 is a top plan view of the floor plank protective cap of FIG. 1;
 FIG. 6 is a bottom plan view of the floor plank protective cap of FIG. 1; and,
 FIG. 7 is a top, front, right side perspective view of the floor plank protective cap of FIG. 1.
 The broken line shown in FIG. 7 is for illustrative purposes only and forms no part of the claimed invention.

1 Claim, 3 Drawing Sheets

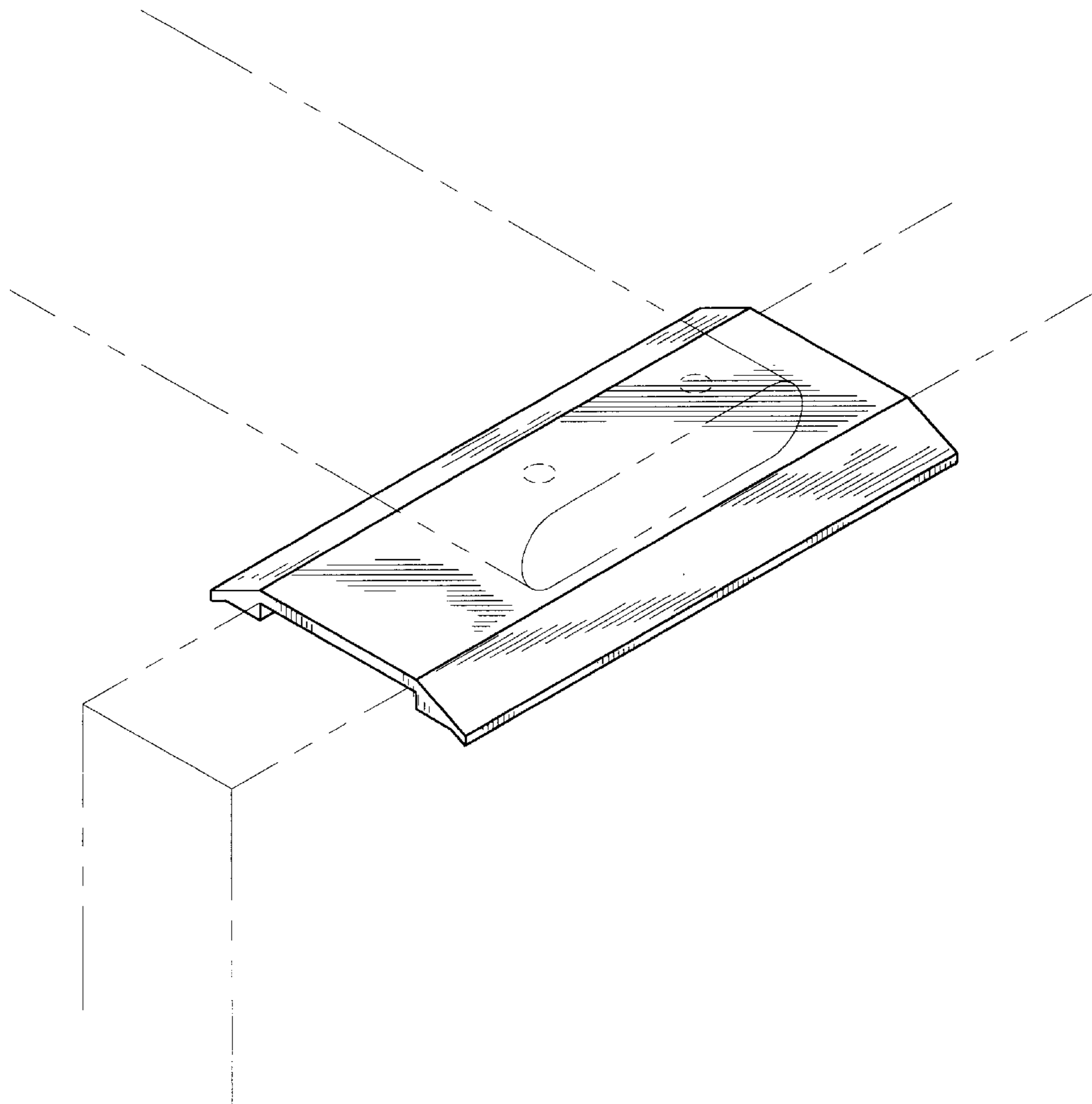

FIG. 1

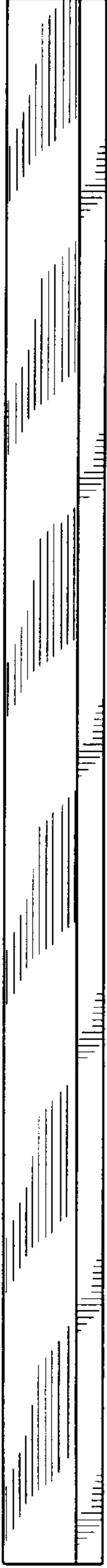

FIG. 2

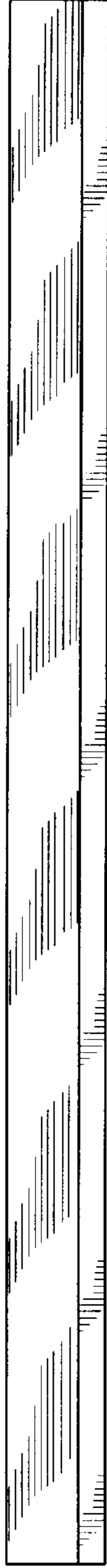

FIG. 4

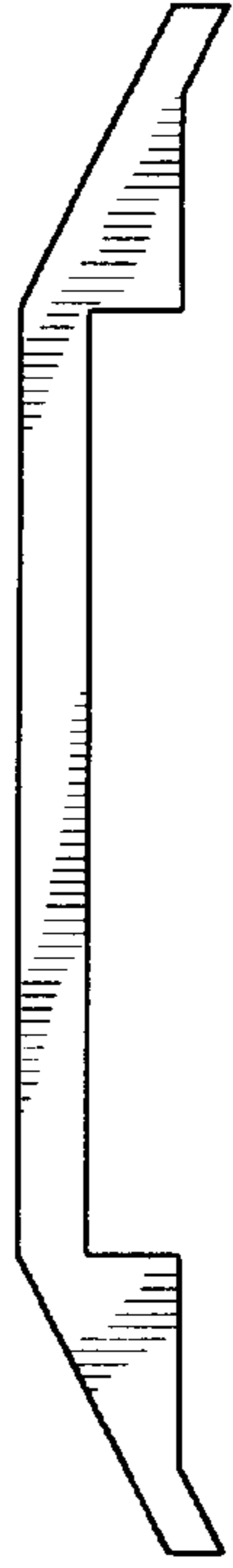
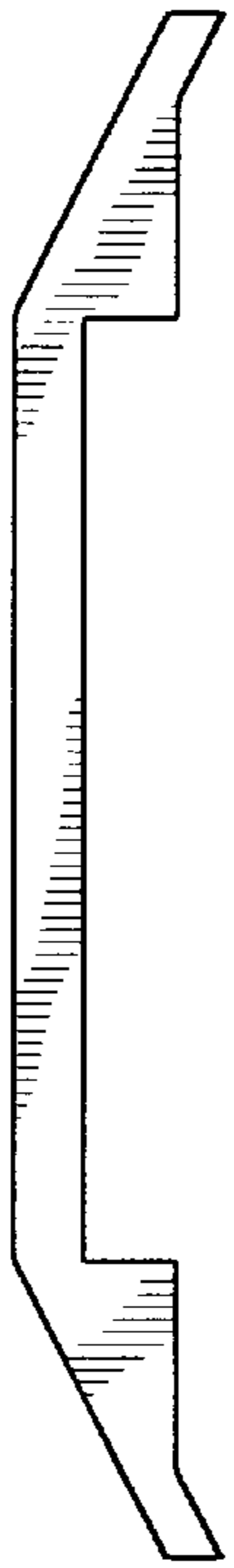

FIG. 3



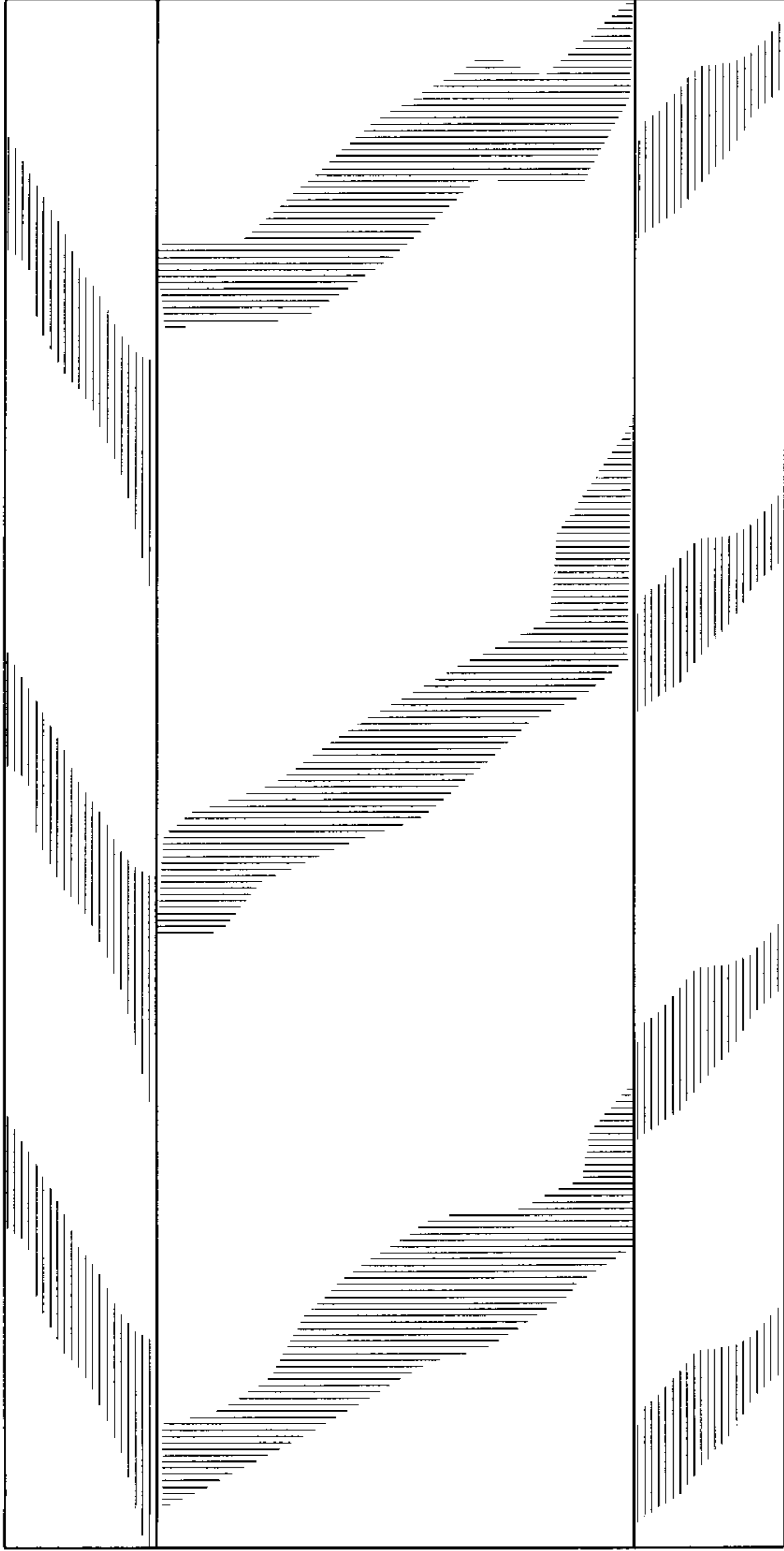

FIG. 5

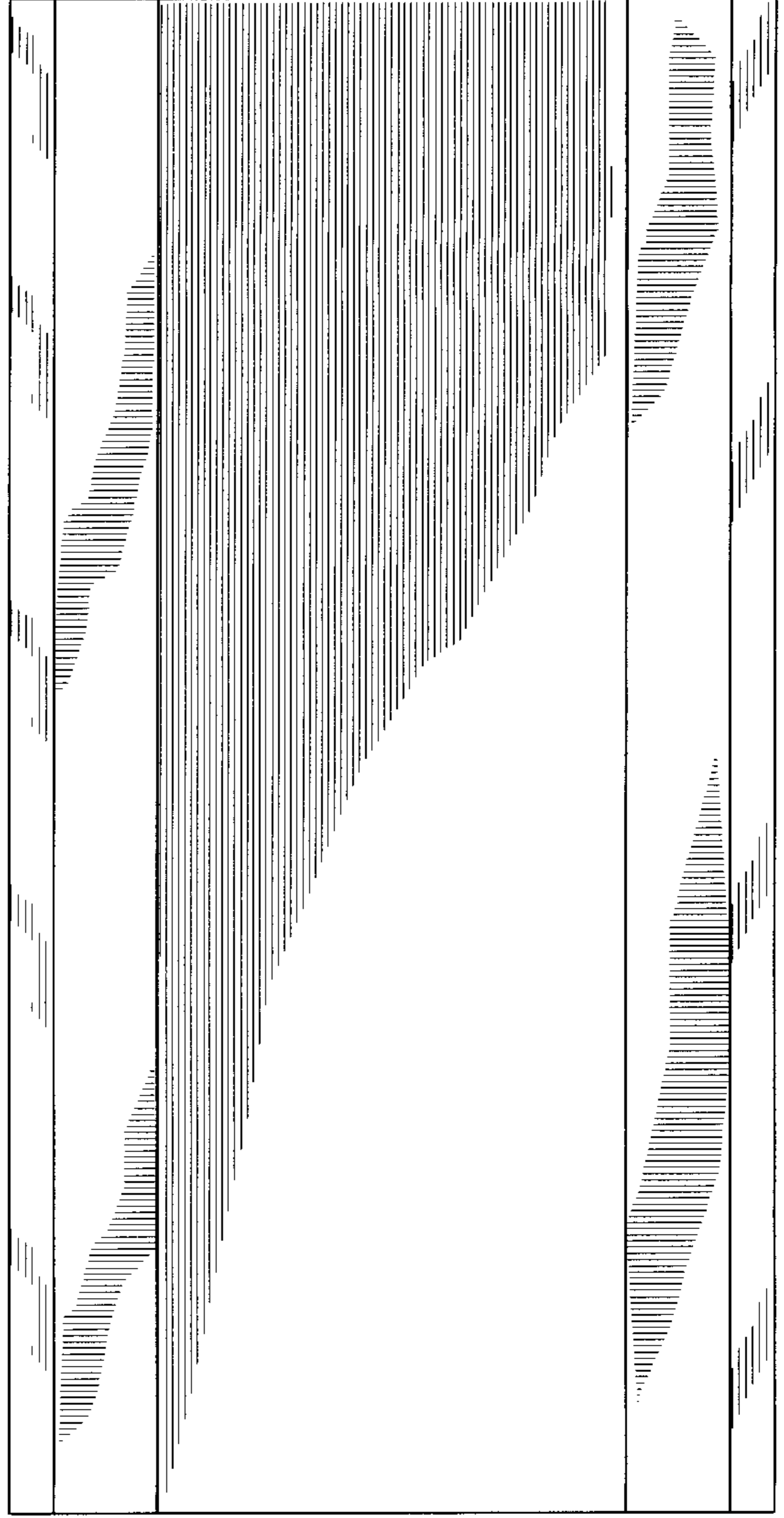

FIG. 6

FIG. 7

