



US00D416318S

# United States Patent [19] Sato

[11] **Patent Number: Des. 416,318**

[45] **Date of Patent: \*\* Nov. 9, 1999**

[54] **AIR CLEANER**

[75] Inventor: **Hisashi Sato**, Tokyo, Japan

[73] Assignee: **Circland Corp.**, Tokyo, Japan

[\*\*] Term: **14 Years**

[21] Appl. No.: **29/093,818**

[22] Filed: **Sep. 18, 1998**

[51] **LOC (6) Cl.** ..... **23-04**

[52] **U.S. Cl.** ..... **D23/364; D23/355**

[58] **Field of Search** ..... **D23/355, 364, D23/365; 96/97; 55/356; 422/122, 120**

[56] **References Cited**

**U.S. PATENT DOCUMENTS**

D. 392,378 3/1998 Sato ..... D23/364

*Primary Examiner*—Lisa Lichtenstein  
*Attorney, Agent, or Firm*—J. Warren Whitesel; Laff, Whitesel & Saret

[57] **CLAIM**

The ornamental design for an air cleaner, as shown.

**DESCRIPTION**

FIG. 1 is a front elevational view of an air cleaner, showing my new design;

FIG. 2 is a right side elevational view thereof;

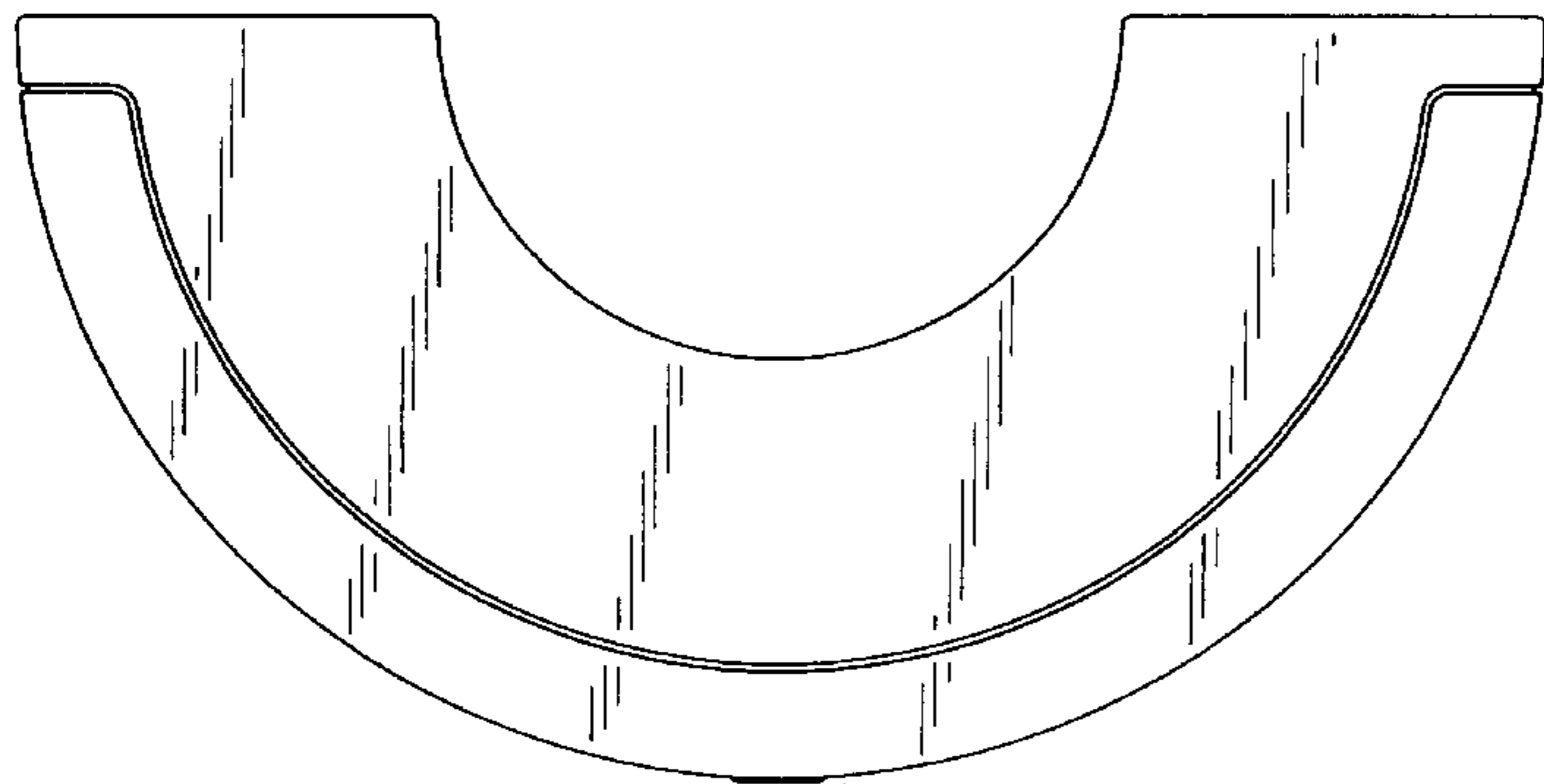
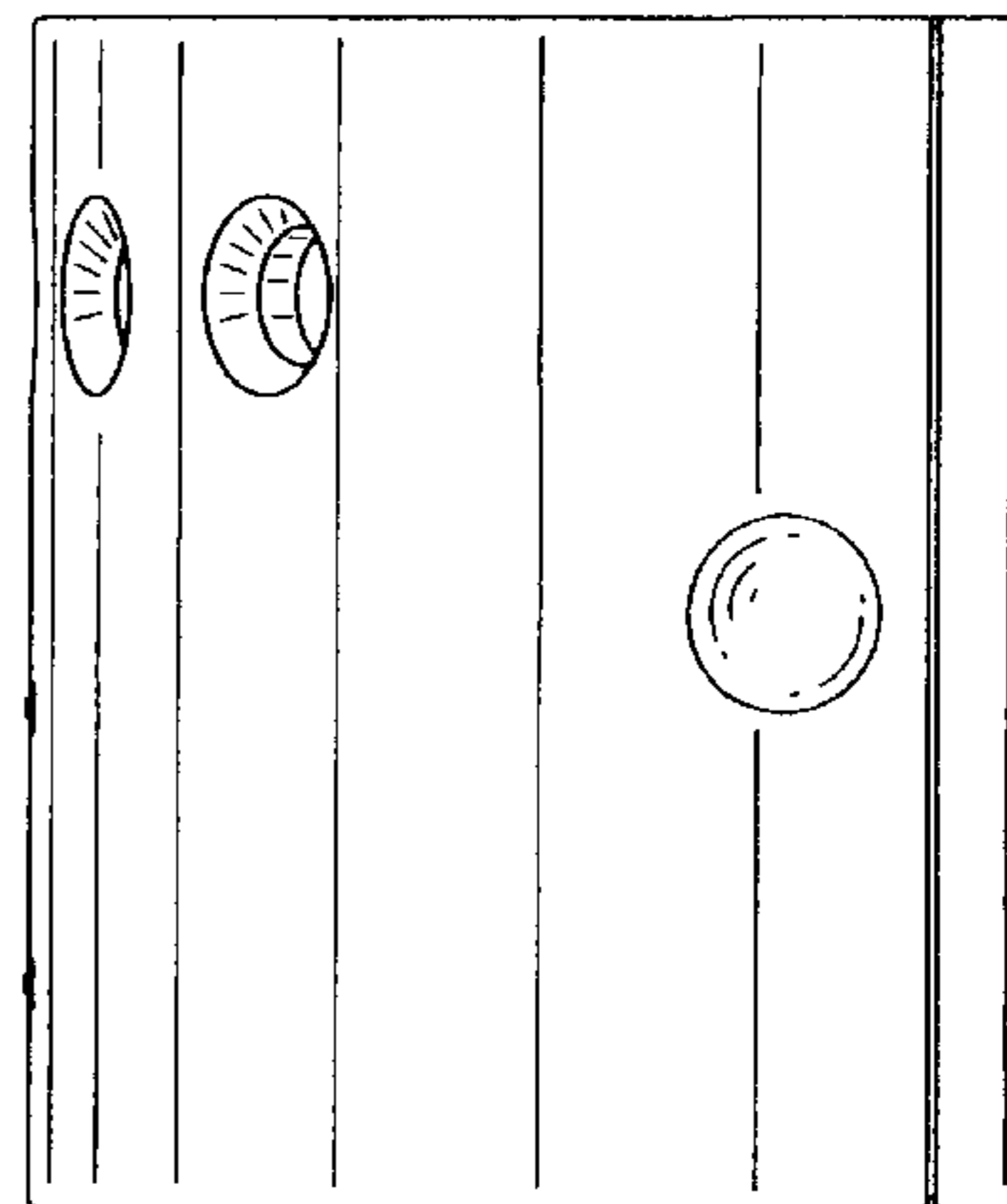
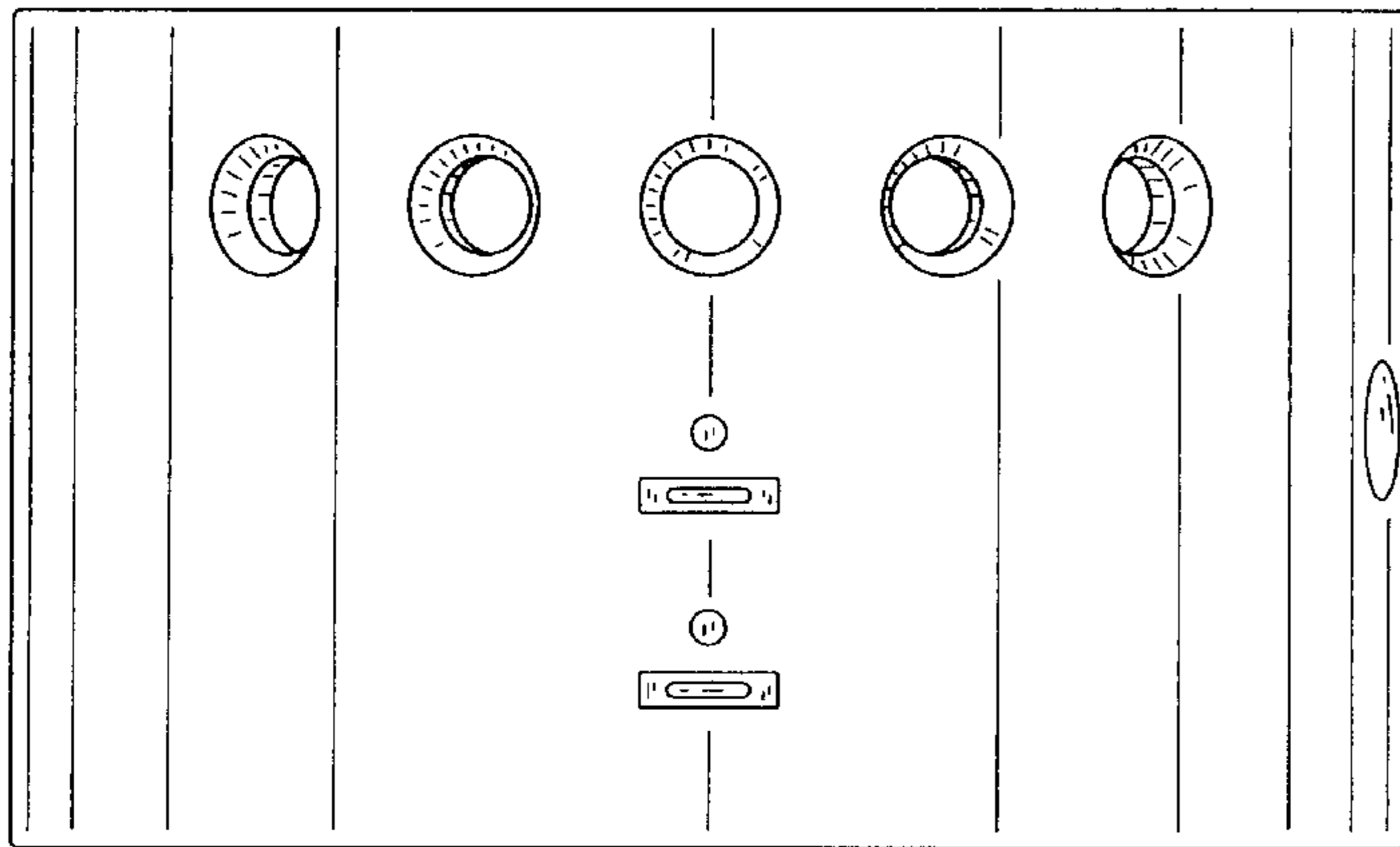
FIG. 3 is a top plan view thereof;

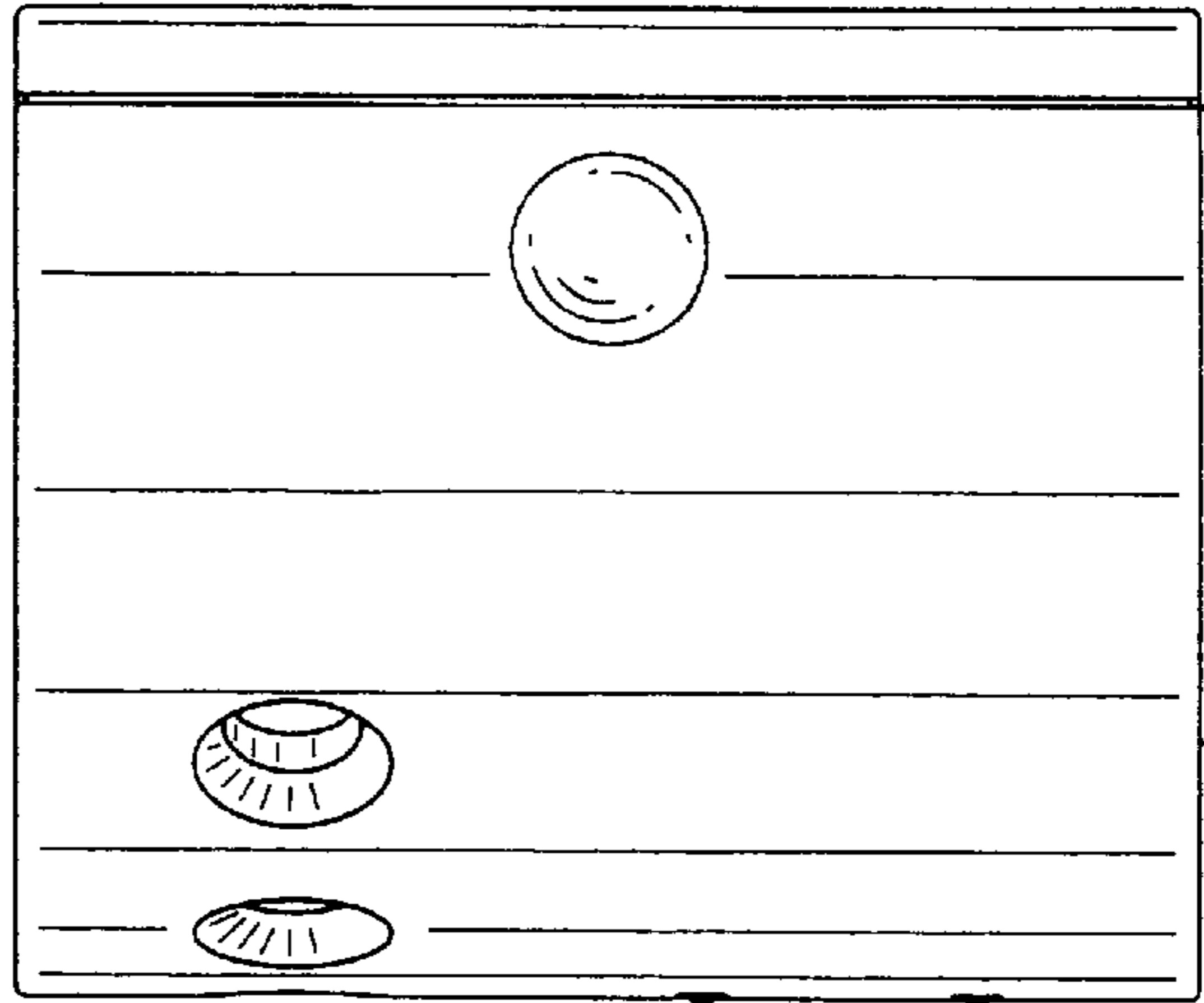
FIG. 4 is a rear elevational view thereof;

FIG. 5 is a left side elevational view thereof; and,

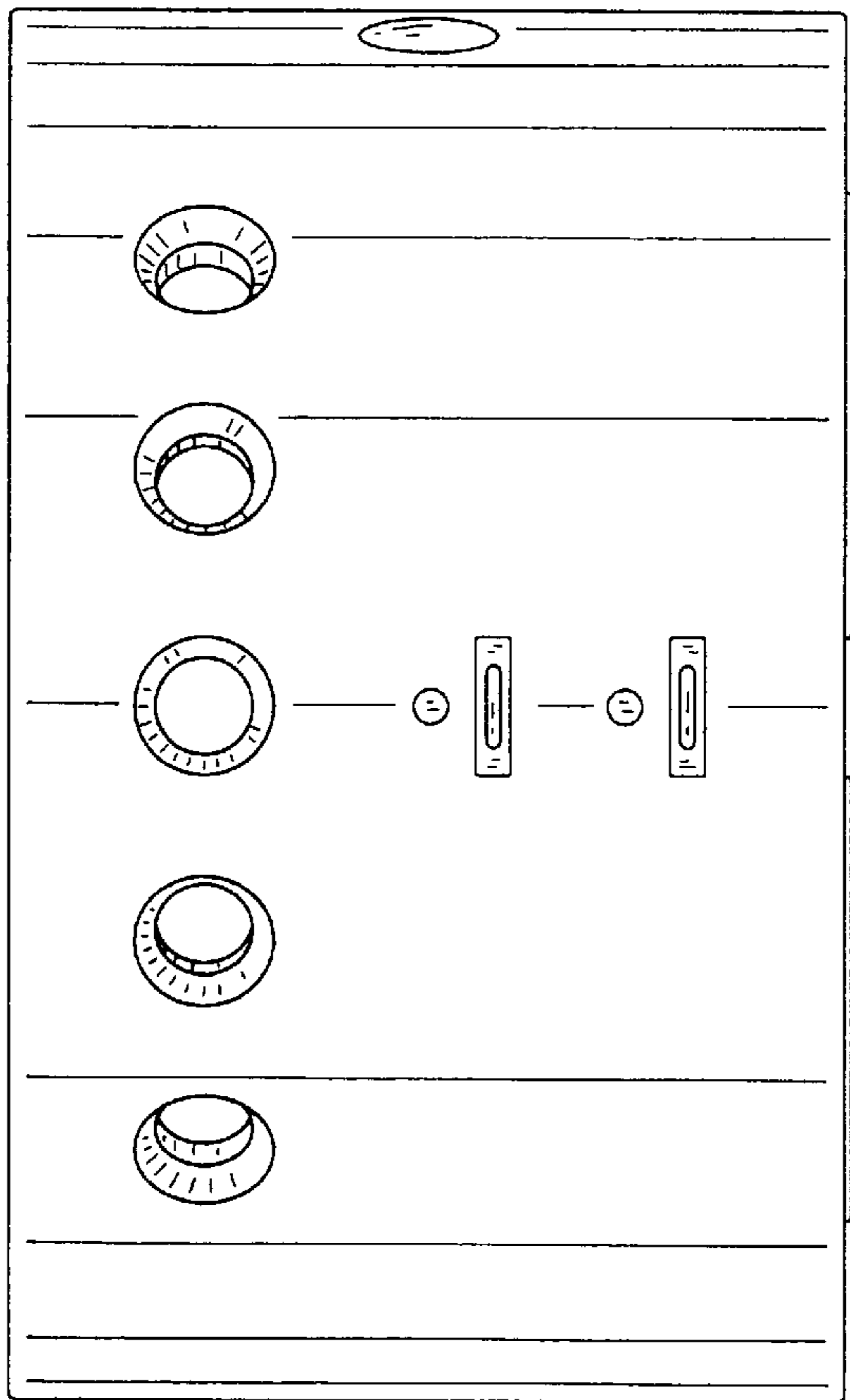
FIG. 6 is a bottom plan view thereof.

**1 Claim, 2 Drawing Sheets**

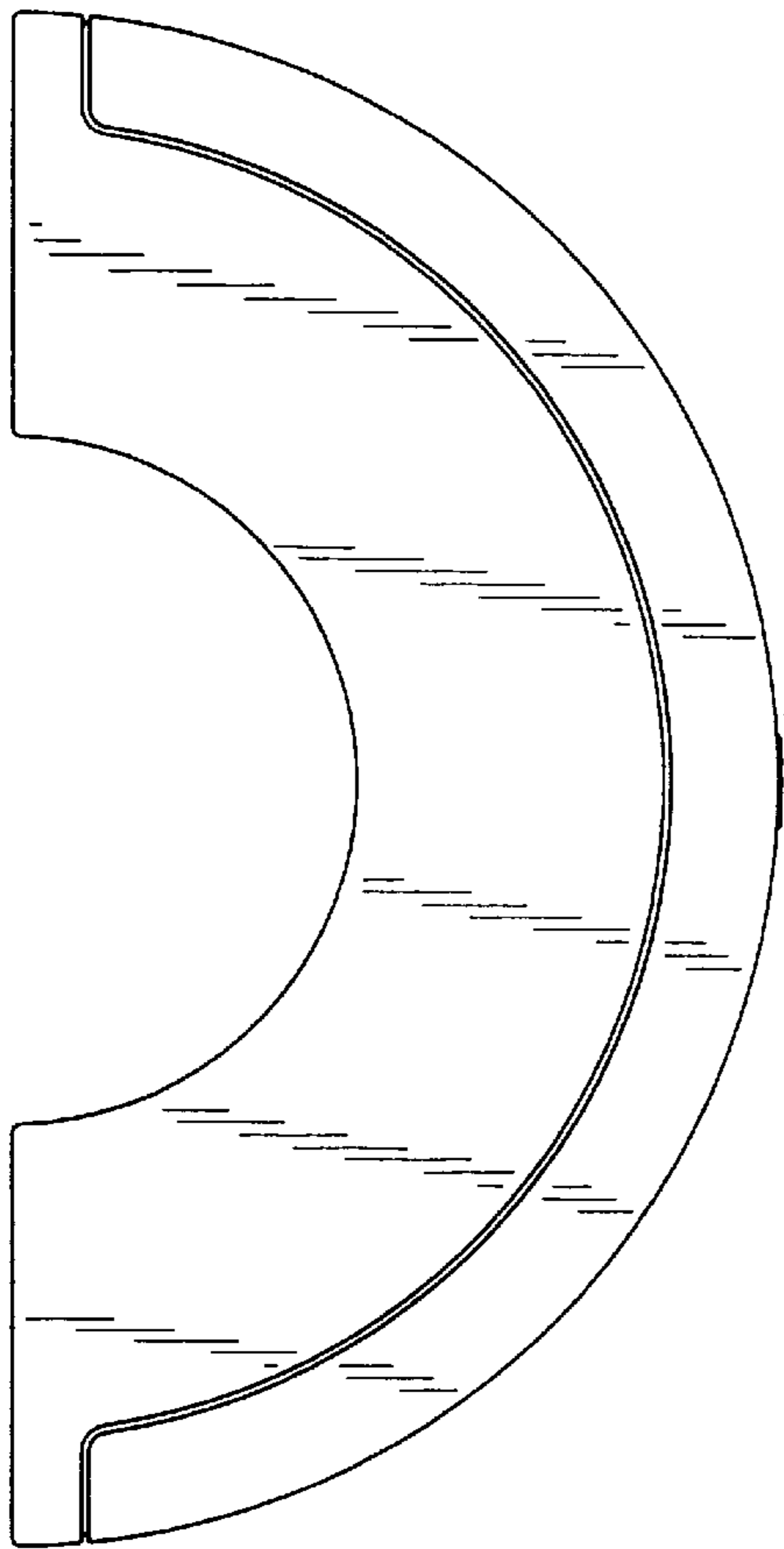




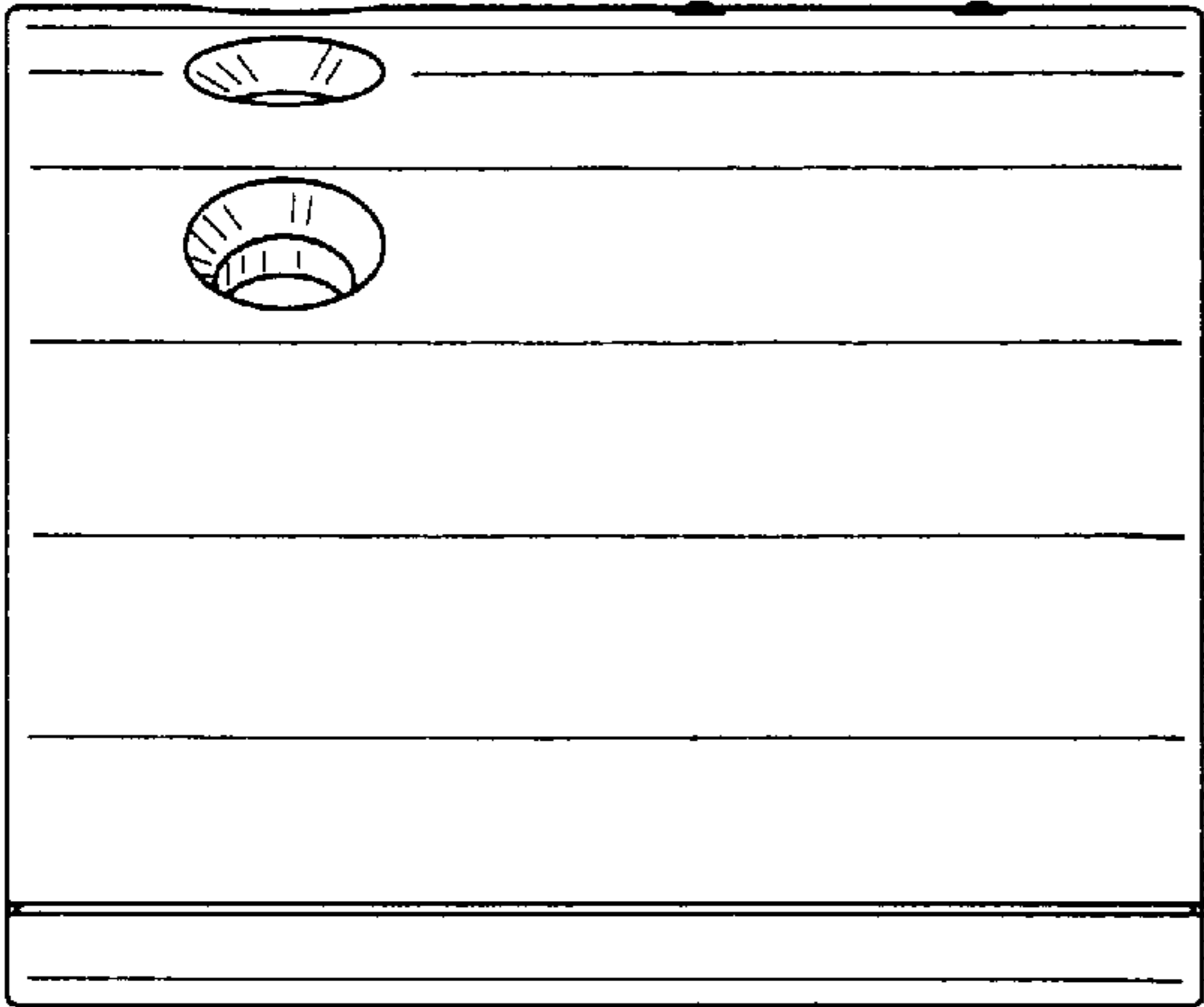
*Fig. 2*



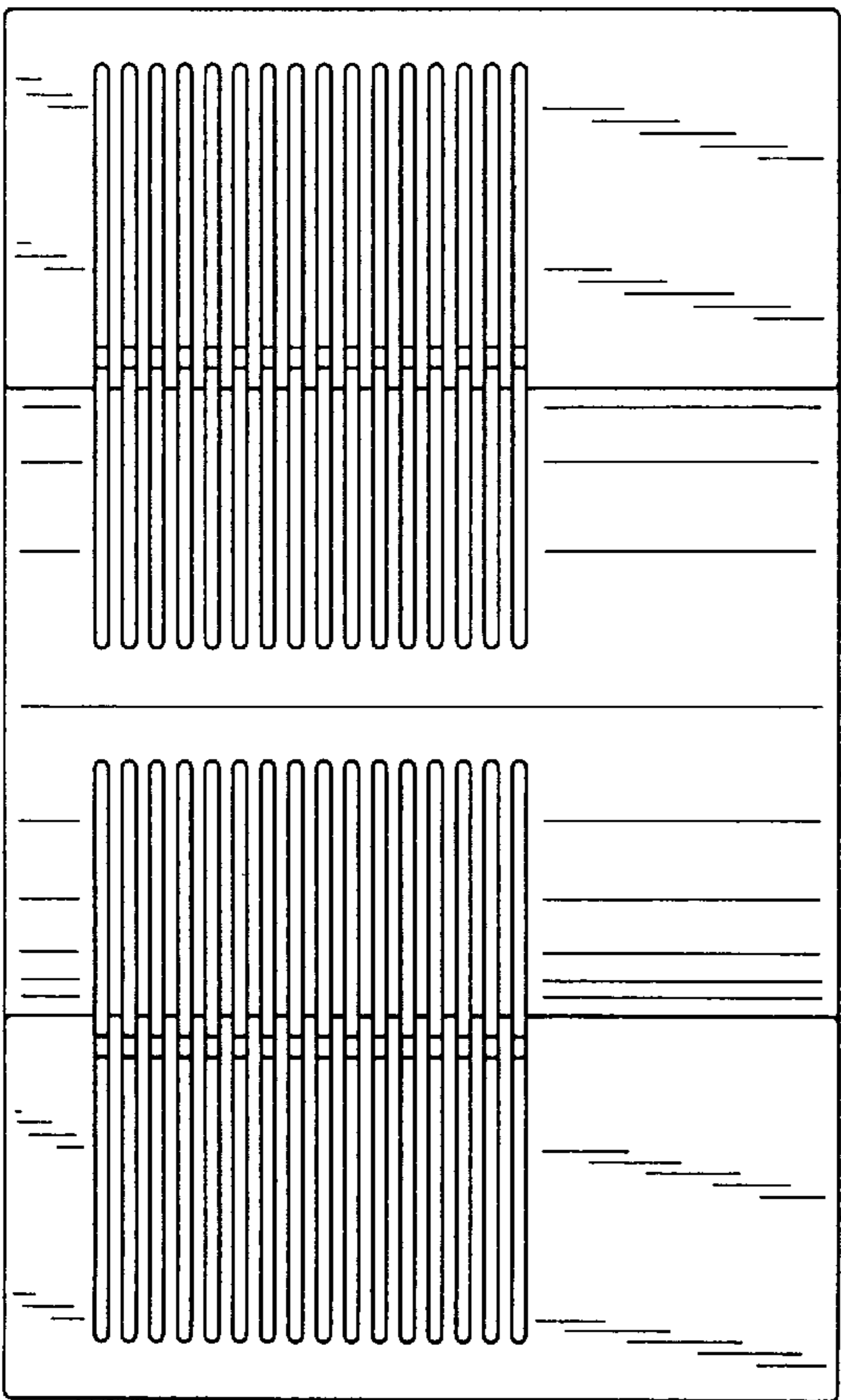
*Fig. 1*



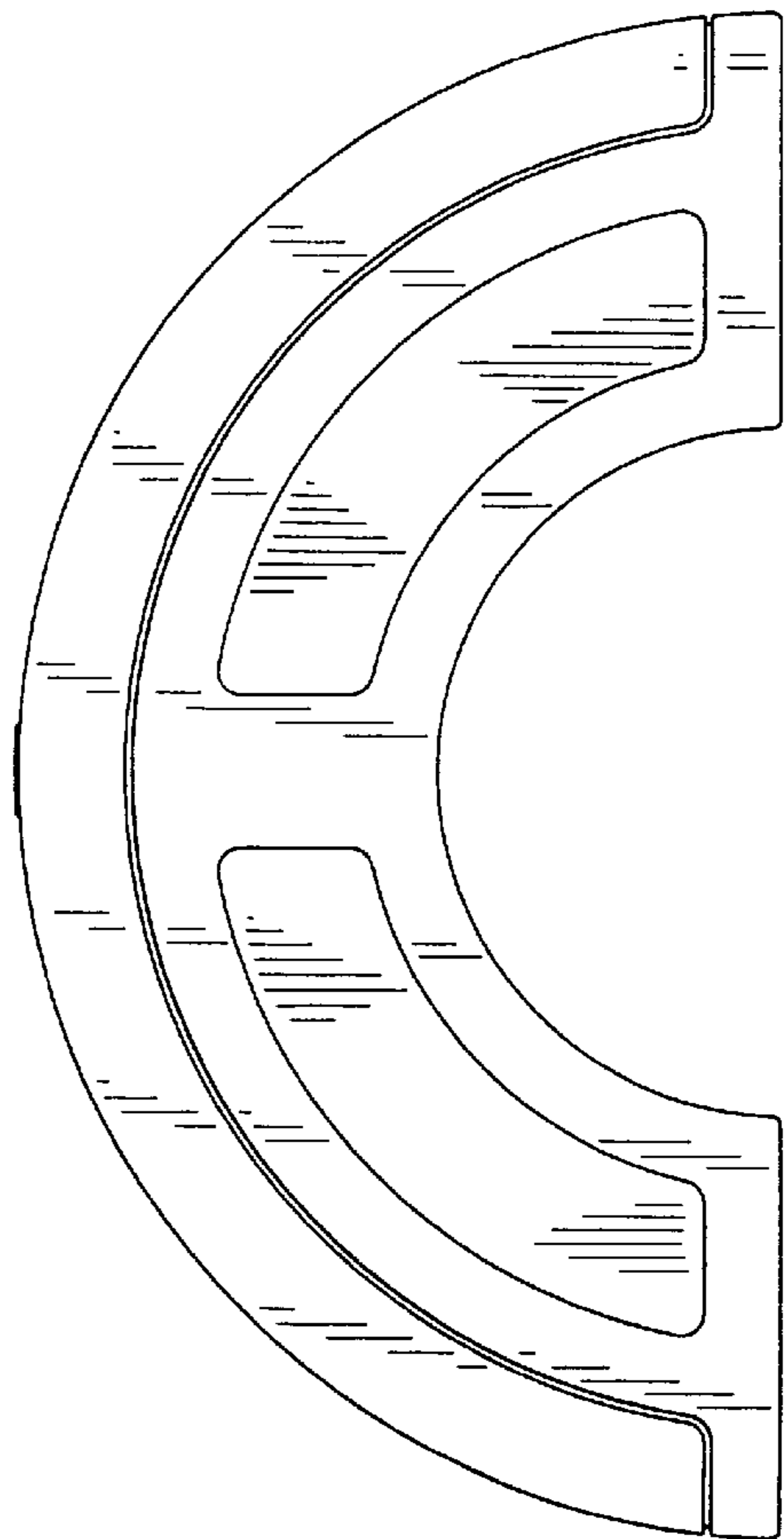
*Fig. 3*



*Fig. 5*



*Fig. 4*



*Fig. 6*