



US00D416316S

United States Patent [19]

Cox et al.

[11] Patent Number: **Des. 416,316**

[45] Date of Patent: **** Nov. 9, 1999**

[54] **HUMIDIFIER**

[75] Inventors: **Paul Cox; Thomas S. Chan**, both of Brighton; **Kenneth David Harris, Jr.**, Boston; **Clinton E. Cockrill**, Roxbury; **James L. Pettingill**, Billerica, all of Mass.

[73] Assignee: **Honeywell Inc.**, Minneapolis, Minn.

[**] Term: **14 Years**

[21] Appl. No.: **29/094,589**

[22] Filed: **Oct. 6, 1998**

[51] **LOC (6) Cl.** **23-04**

[52] **U.S. Cl.** **D23/356; D23/358**

[58] **Field of Search** **D23/356-363; 261/107, 91, 104, 72.1; 422/120, 123; 392/403-406, 394**

[56] **References Cited**

U.S. PATENT DOCUMENTS

D. 330,074	10/1992	Wang et al.	D23/356
D. 337,634	7/1993	Copland et al.	D23/356
D. 357,310	4/1995	Chiu et al.	D23/356
D. 358,461	5/1995	Barker et al.	D23/356

D. 362,906	10/1995	Chiu et al.	D23/356
D. 374,921	10/1996	Jane et al.	D23/356
D. 375,349	11/1996	Gonzales	D23/356
D. 382,635	8/1997	Jane et al.	D23/356
D. 385,342	10/1997	Jane et al.	D23/356
D. 388,162	12/1997	Chiu et al.	D23/356
D. 401,316	11/1998	Allen et al.	D23/356
D. 402,021	12/1998	Allen et al.	D23/356

Primary Examiner—Lisa Lichtenstein
Attorney, Agent, or Firm—Robert B. Leonard

[57] **CLAIM**

The ornamental design for a humidifier, as shown.

DESCRIPTION

FIG. 1 is a front perspective view of a humidifier showing our design.
 FIG. 2 is a front elevational view of the humidifier shown in FIG. 1.
 FIG. 3 is a rear elevational view of the humidifier shown in FIG. 1.
 FIG. 4 is a right side elevational view of the humidifier shown if FIG. 1.
 FIG. 5 is a left side elevational view of the humidifier shown in FIG. 1; and,
 FIG. 6 is a top plan view of the humidifier shown in FIG. 1.

1 Claim, 6 Drawing Sheets

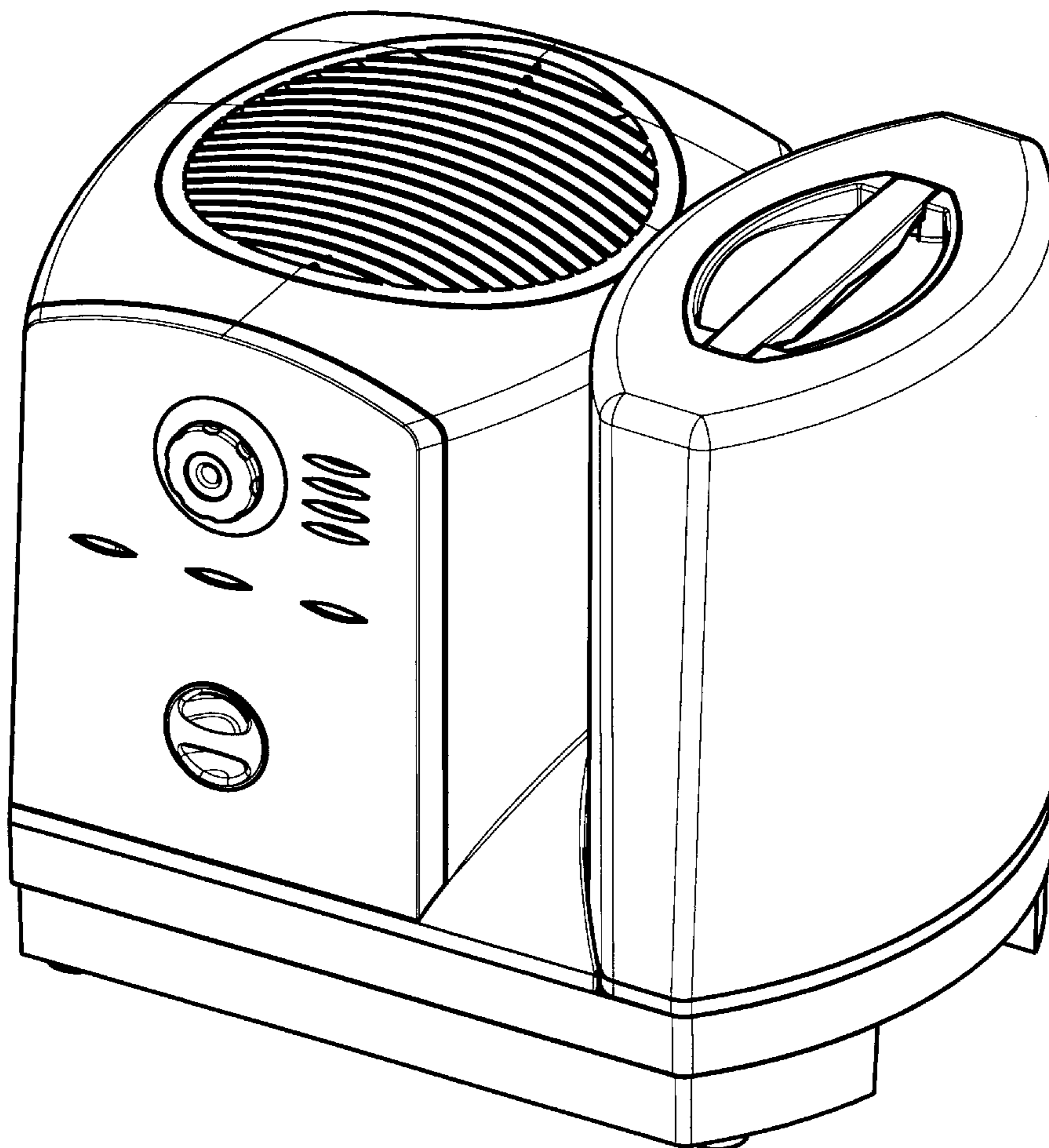

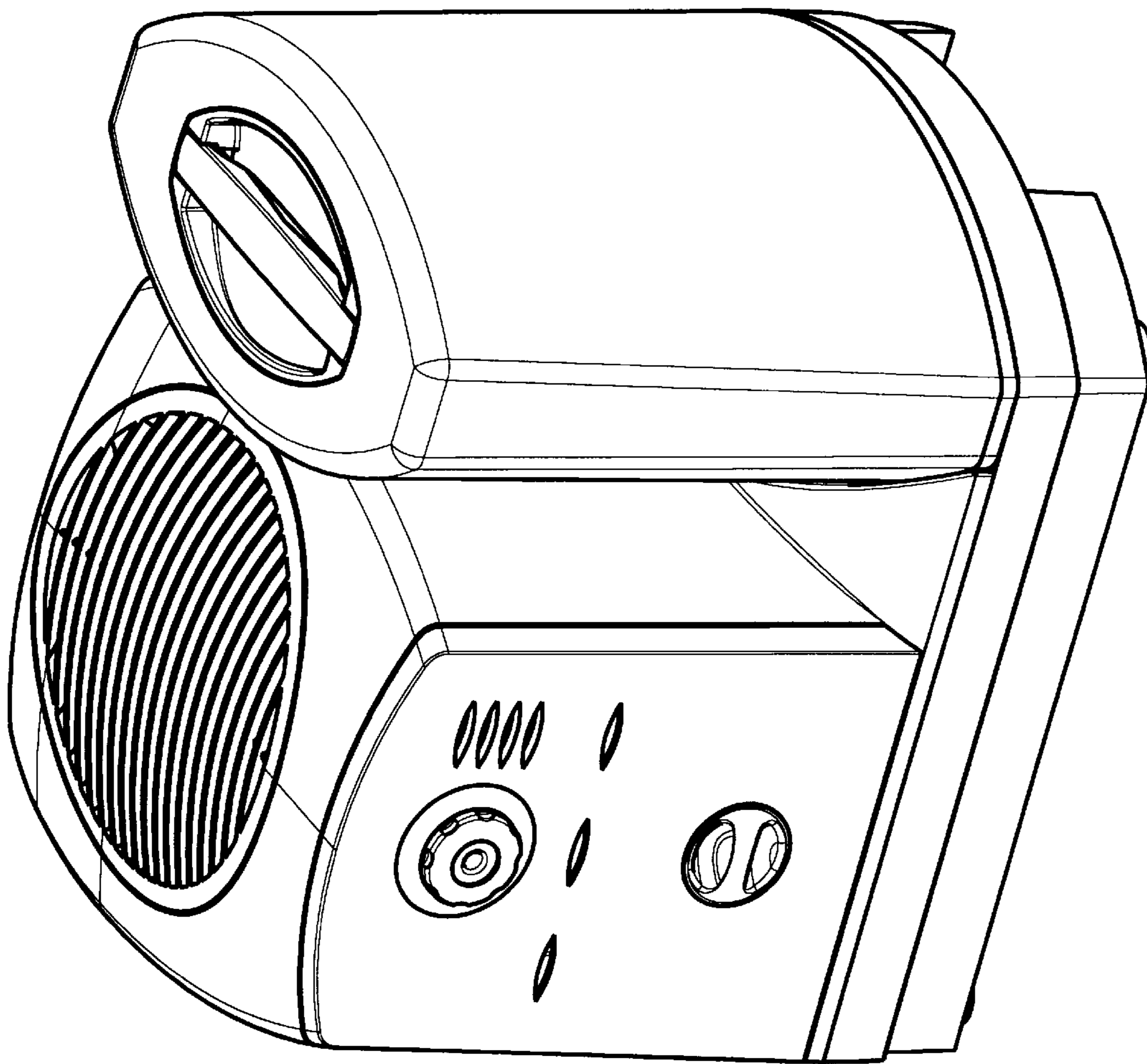

FIGURE 1

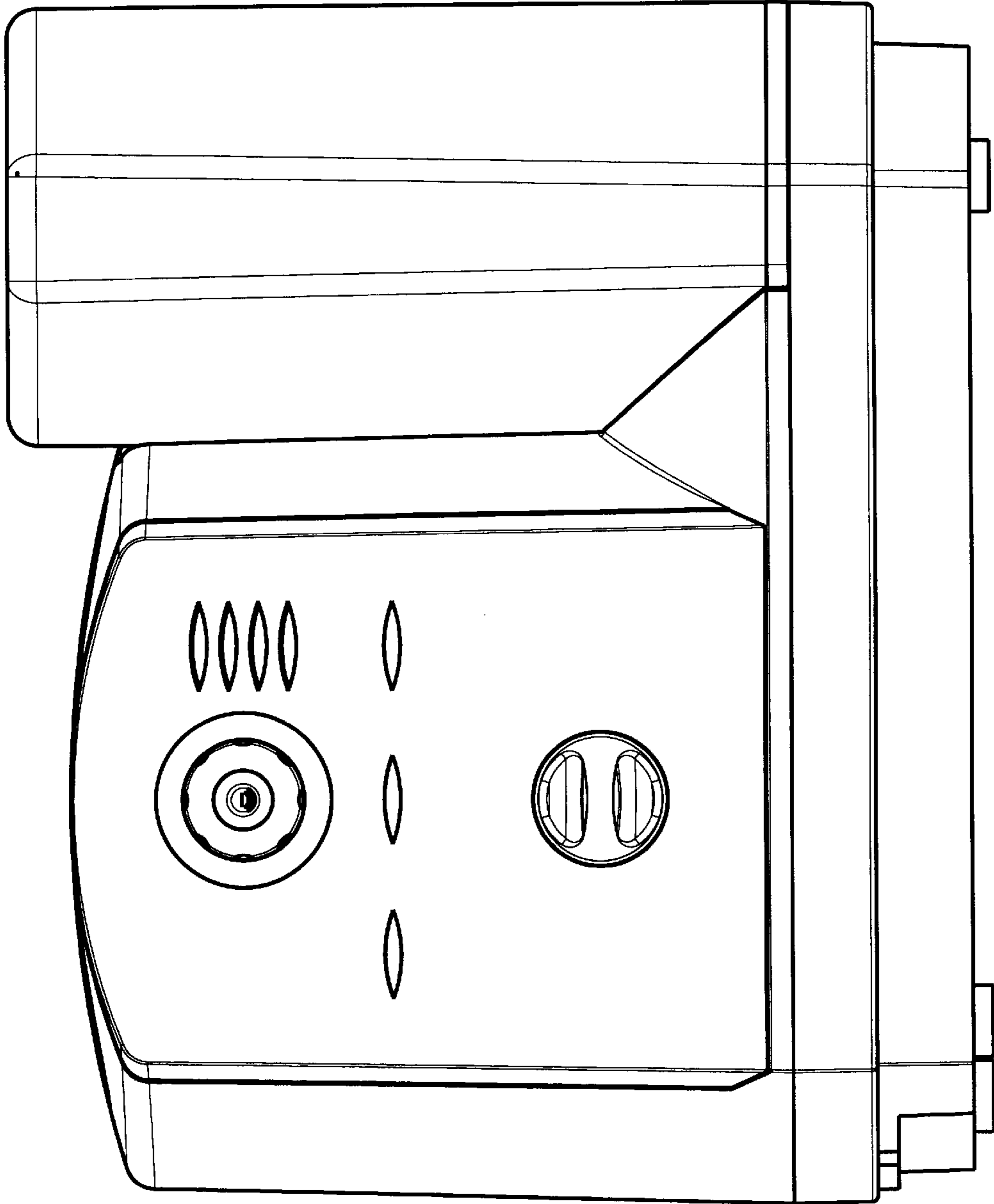

FIGURE 2

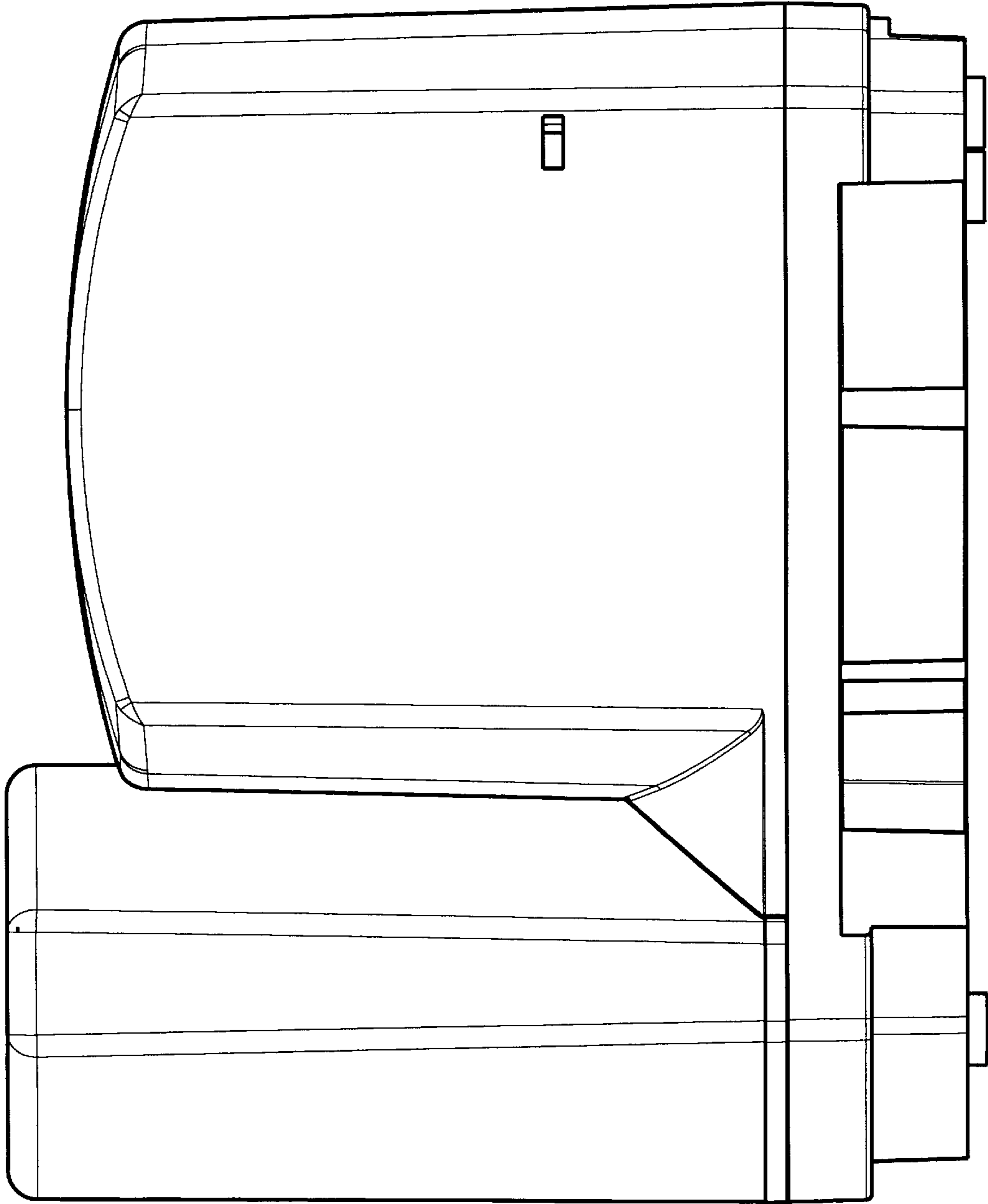

FIGURE 3

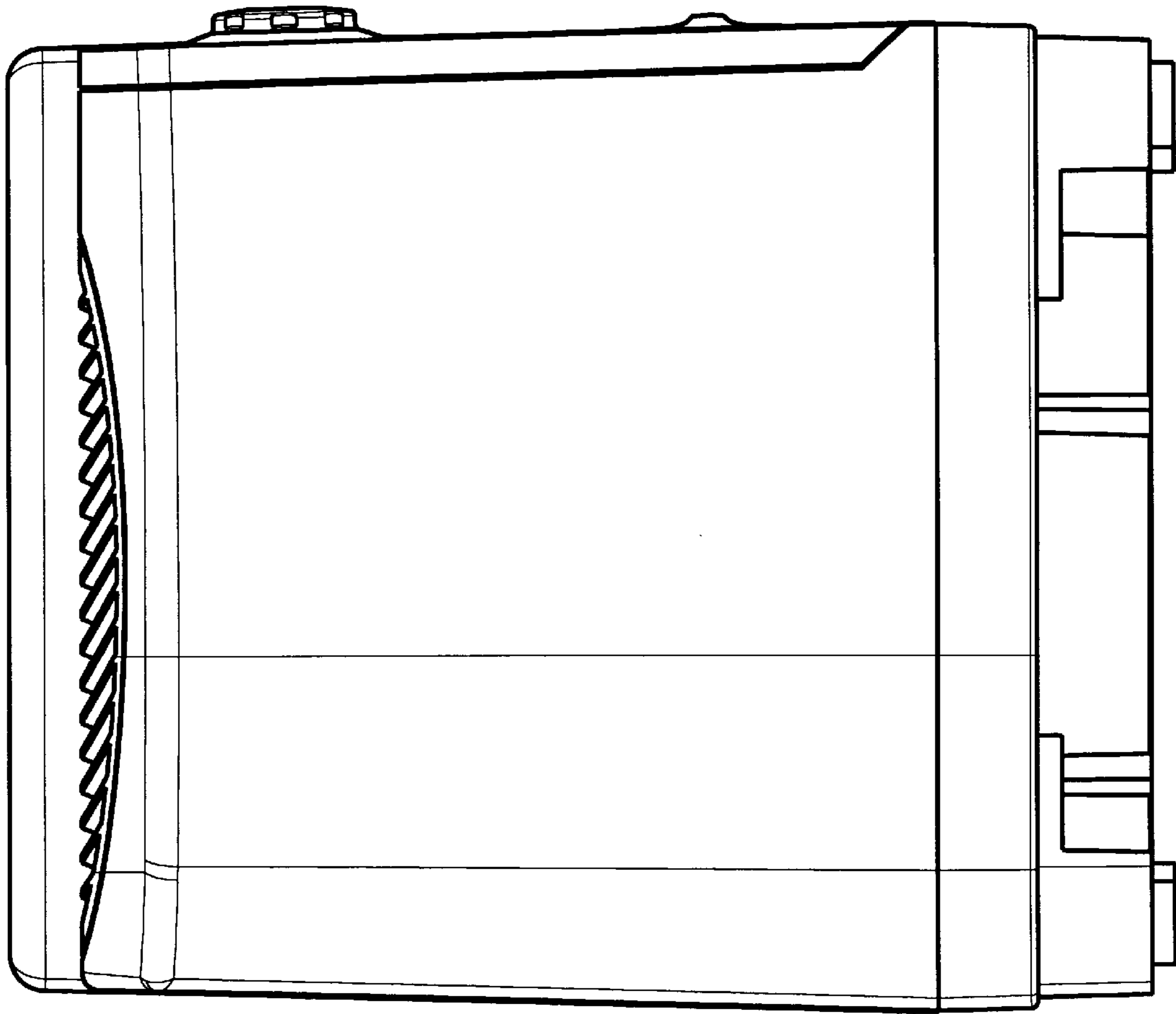

FIGURE 4

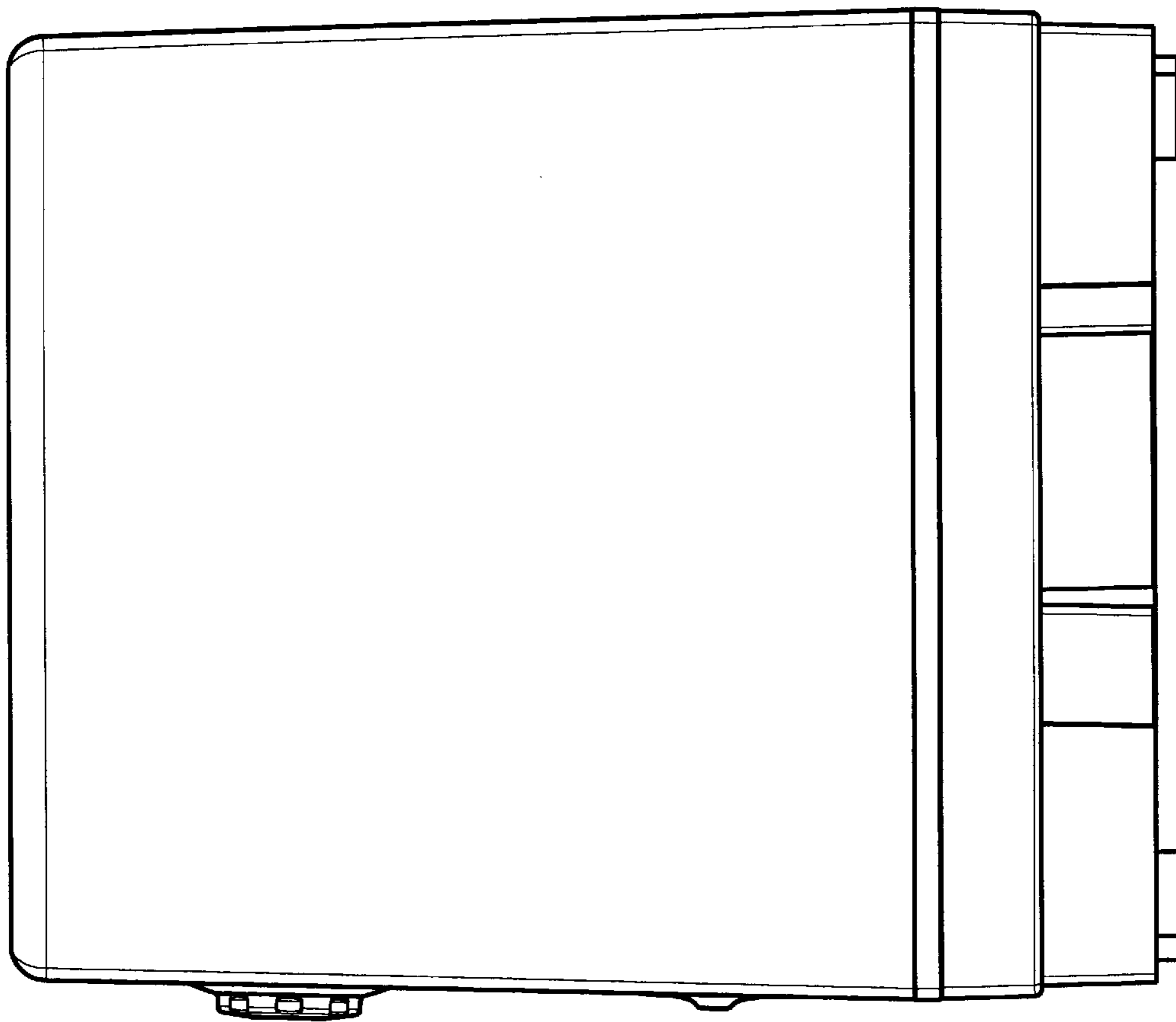

FIGURE 5

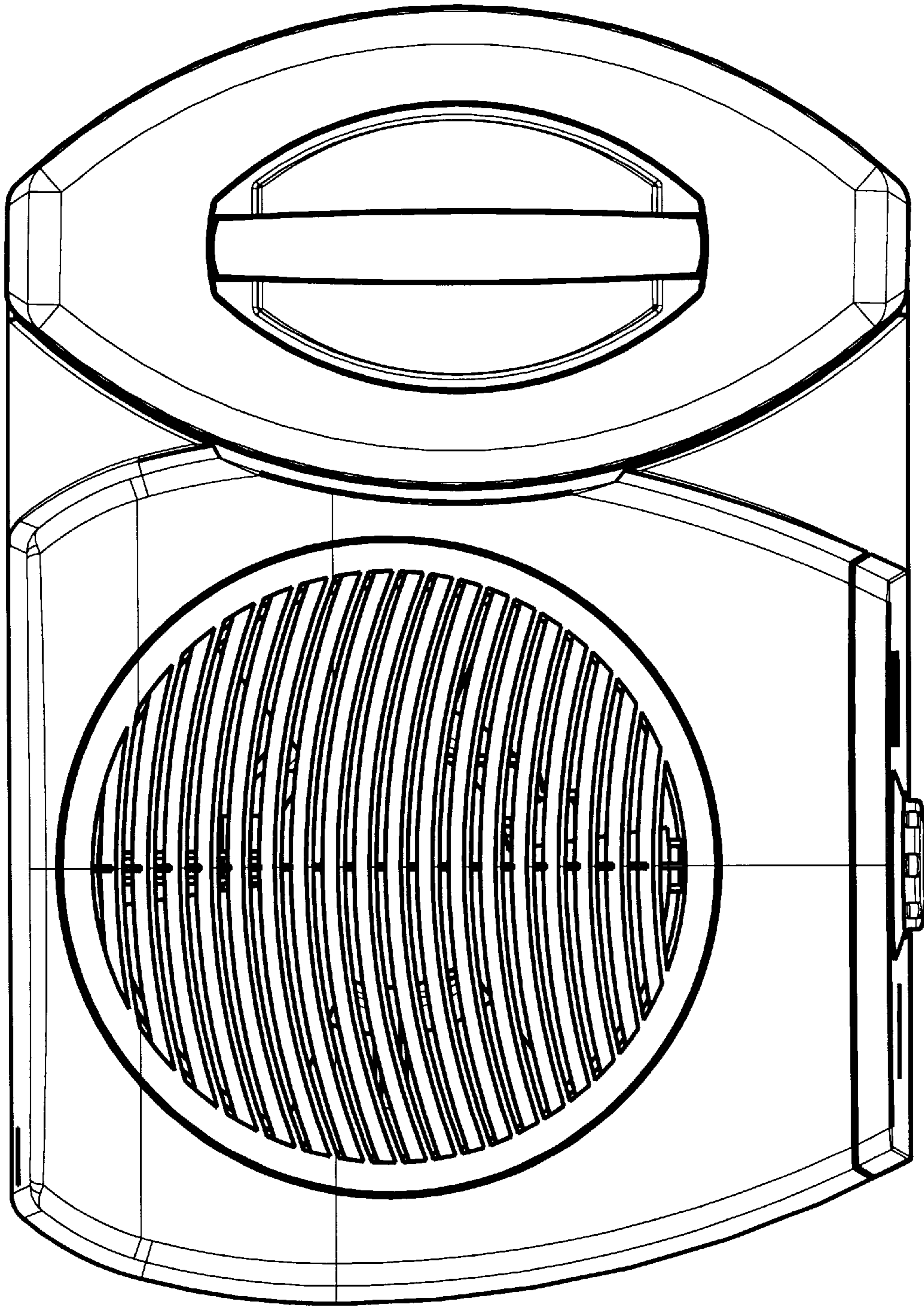

FIGURE 6