



US00D416307S

United States Patent [19]
Williams

[11] **Patent Number: Des. 416,307**

[45] **Date of Patent: ** Nov. 9, 1999**

[54] **PURIFIER**

[76] Inventor: **Richard T. Williams**, P.O. Box 39,
Uwchland, Chester County, Pa. 19480

[**] Term: **14 Years**

[21] Appl. No.: **29/090,520**

[22] Filed: **Jul. 10, 1998**

[51] **LOC (6) Cl.** **23-01**

[52] **U.S. Cl.** **D23/209**

[58] **Field of Search** D23/200, 207,
D23/209; 210/264, 266, 282, 435, 459,
460

[56] **References Cited**

U.S. PATENT DOCUMENTS

D. 309,492	7/1990	Boehnke	D23/209
D. 316,740	5/1991	Kopf	D23/209
D. 357,058	4/1995	Engerhard	D23/209
D. 370,521	6/1996	Archer et al.	D23/207
D. 377,826	2/1997	Robbins	D23/209
5,651,887	7/1997	Posner et al.	210/282

Primary Examiner—Alan P. Douglas

Assistant Examiner—Robin V. Taylor

Attorney, Agent, or Firm—John F. A. Earley; John F. A. Earley, III; Harding, Earley, Follmer & Frailey

[57] **CLAIM**

The ornamental designs for a purifier, as shown and described.

DESCRIPTION

FIG. 1 is a view in perspective of a first embodiment of the

purifier;

FIG. 2 is a view in elevation of the front side of the purifier shown in FIG. 1;

FIG. 3 is a view in elevation of the right side of the purifier shown in FIG. 1;

FIG. 4 is a view in elevation of the left side of the purifier shown in FIG. 1;

FIG. 5 is a view in elevation of the rear side of the purifier shown in FIG. 1;

FIG. 6 is a top plan view of the purifier shown in FIG. 1;

FIG. 7 is a bottom plan view of the purifier shown in FIG. 1;

FIG. 8 is a view in perspective of a second embodiment of the purifier;

FIG. 9 is a view in elevation of the front side of the purifier shown in FIG. 8;

FIG. 10 is a view in elevation of the right side of the purifier shown in FIG. 8;

FIG. 11 is a view in elevation of the left side of the purifier shown in FIG. 8;

FIG. 12 is a view in elevation of the rear side of the purifier shown in FIG. 8;

FIG. 13 is a top plan view of the purifier shown in FIG. 8; and,

FIG. 14 is a bottom plan view of the purifier shown in FIG. 8.

The broken line showing is for illustrative purposes only and forms no part of the claimed design.

1 Claim, 10 Drawing Sheets

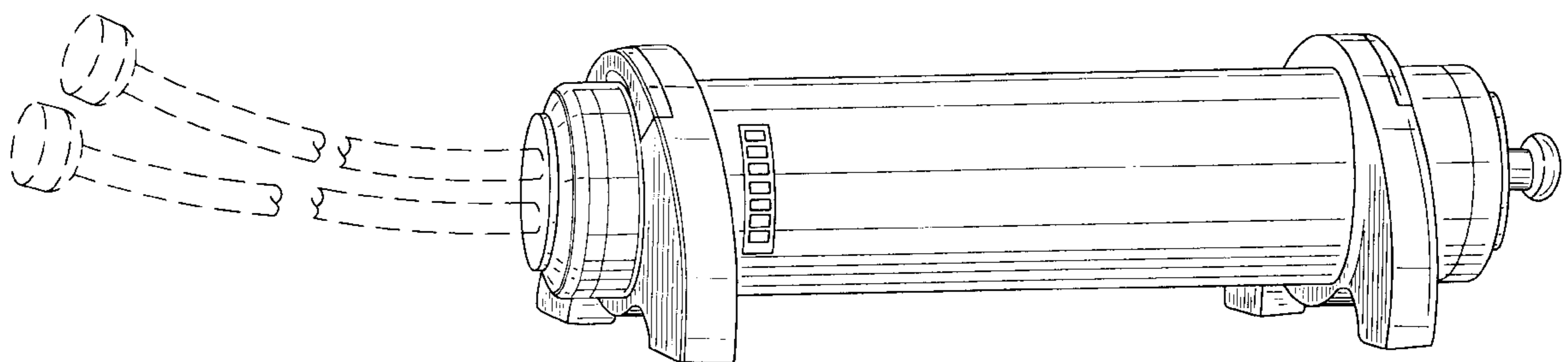

FIG. 1

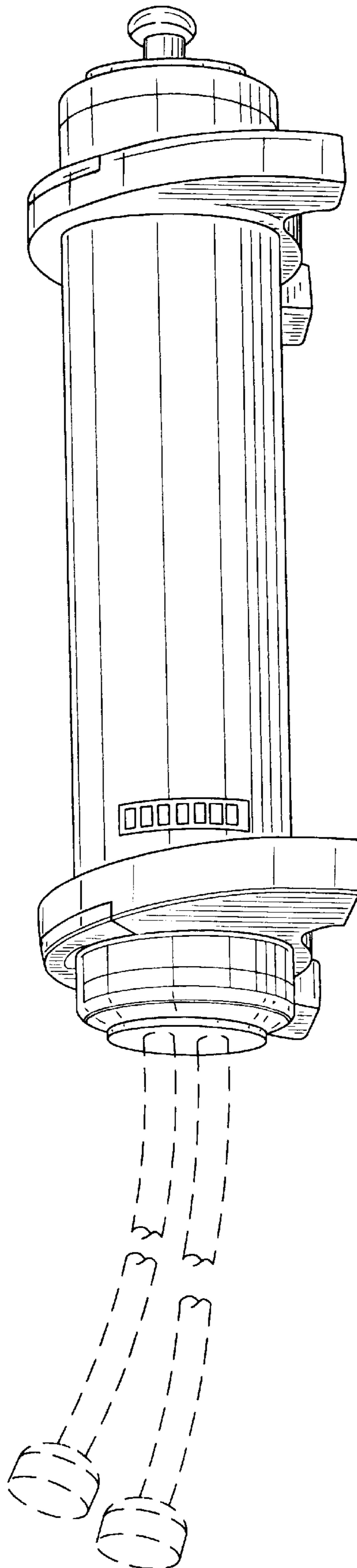

FIG. 2

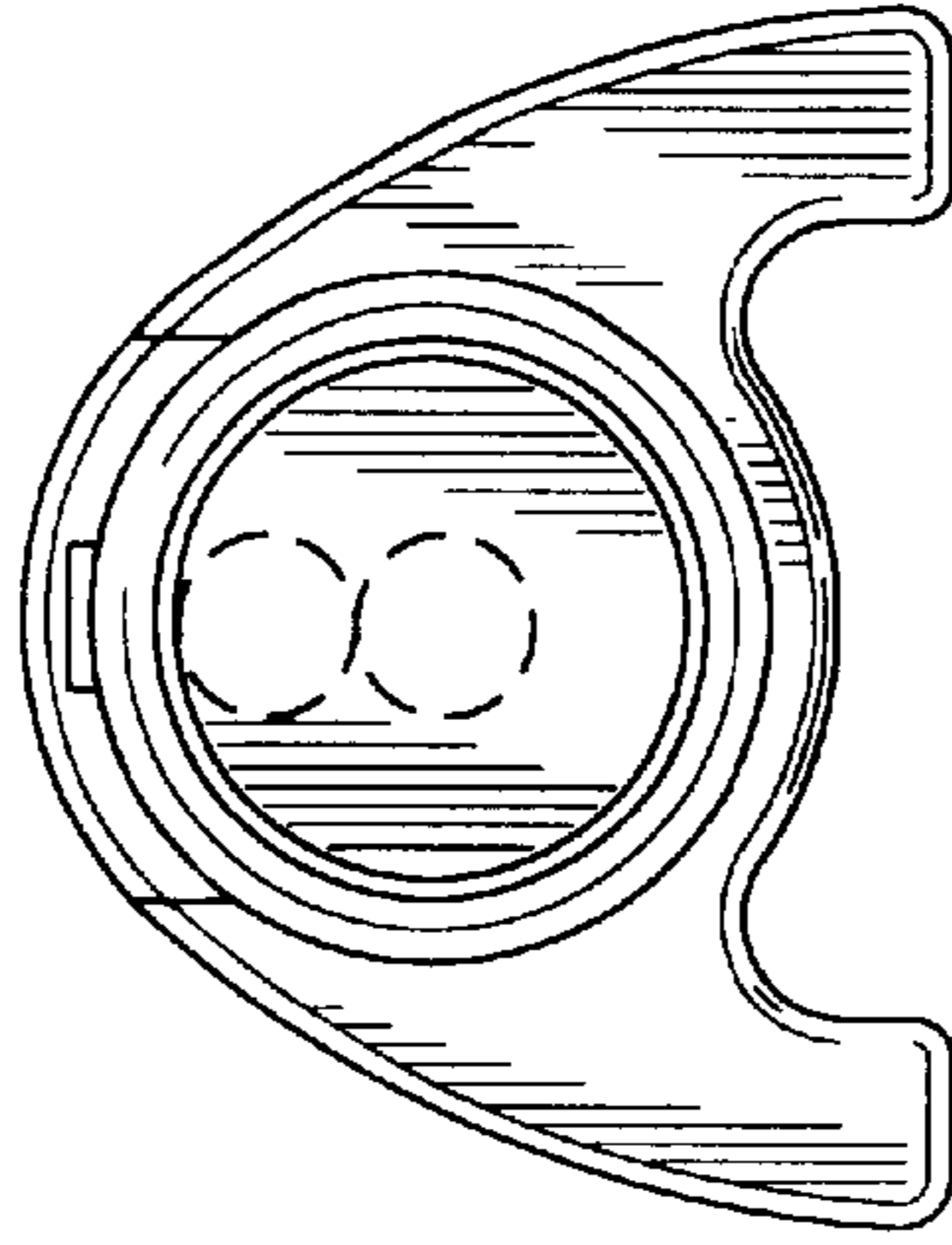

FIG. 3

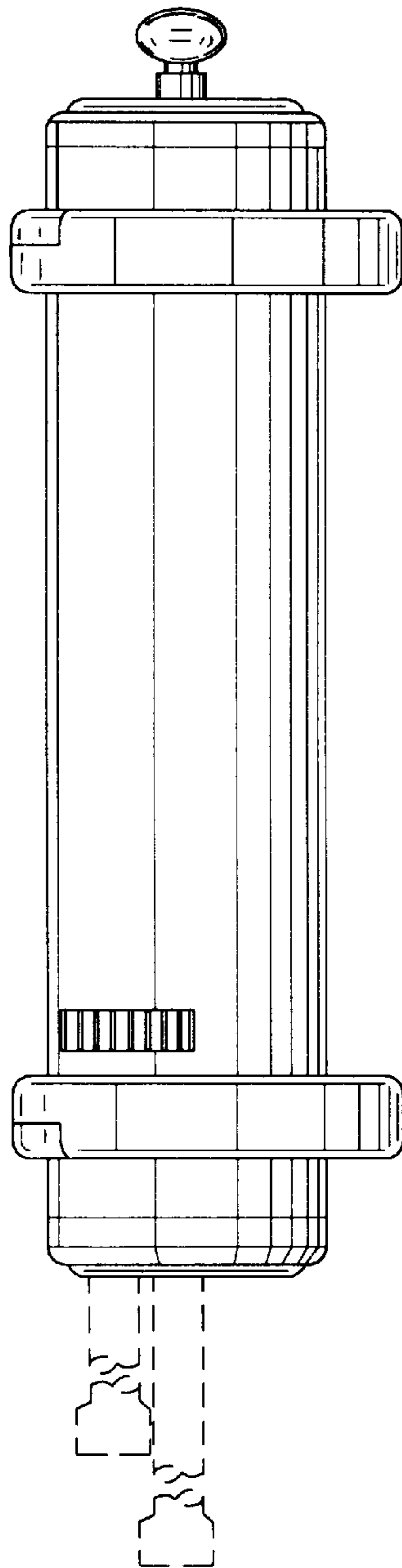

FIG. 5

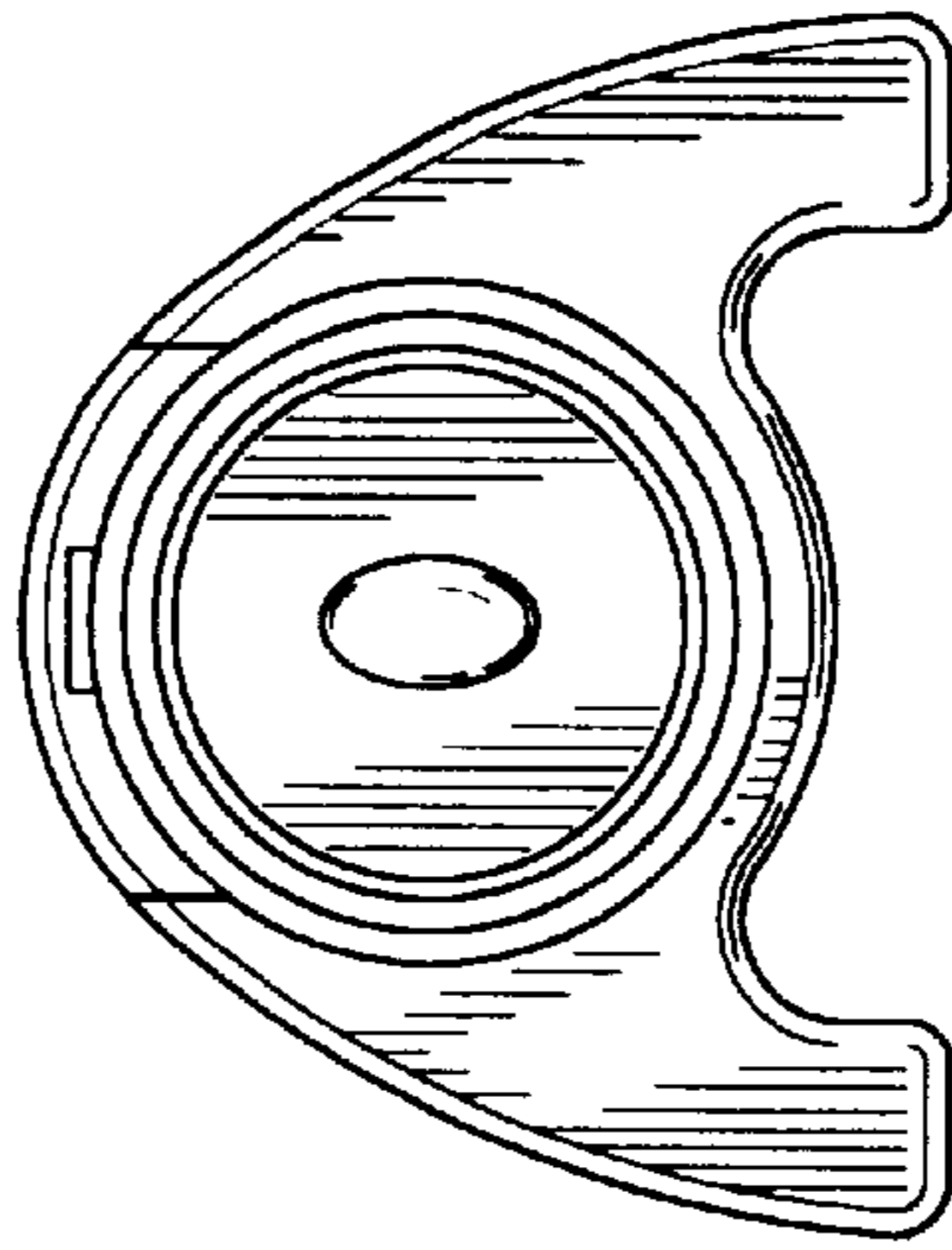

FIG. 4

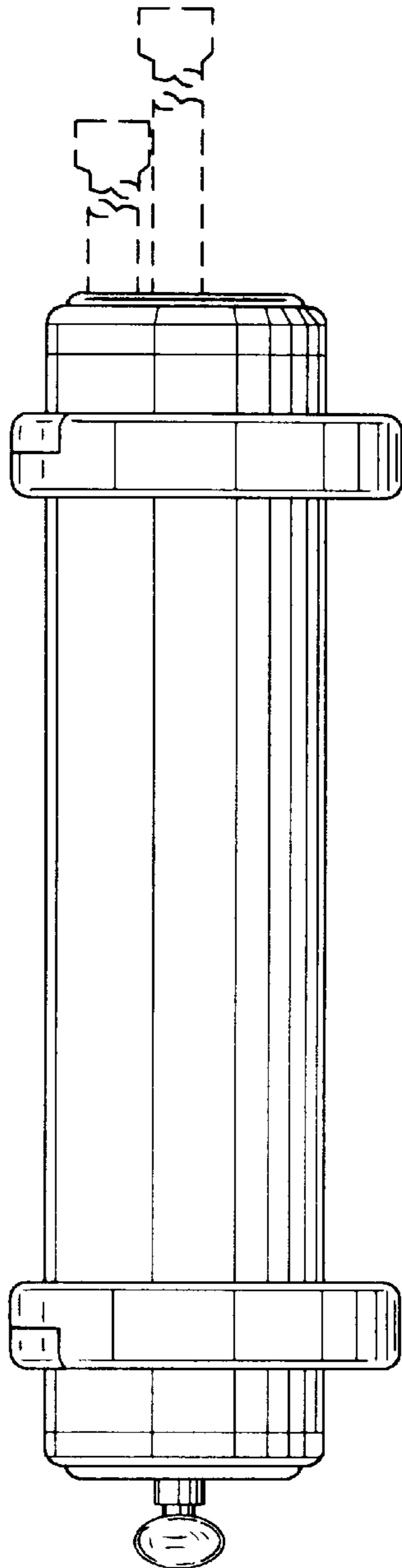

FIG. 6

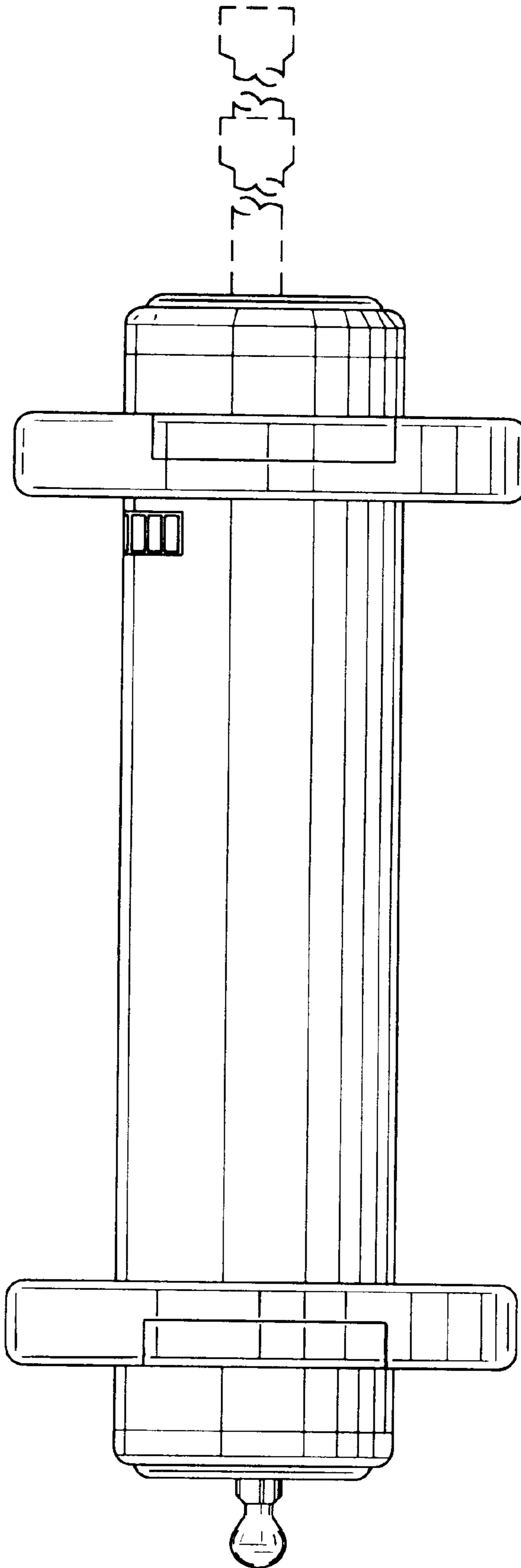

FIG. 7

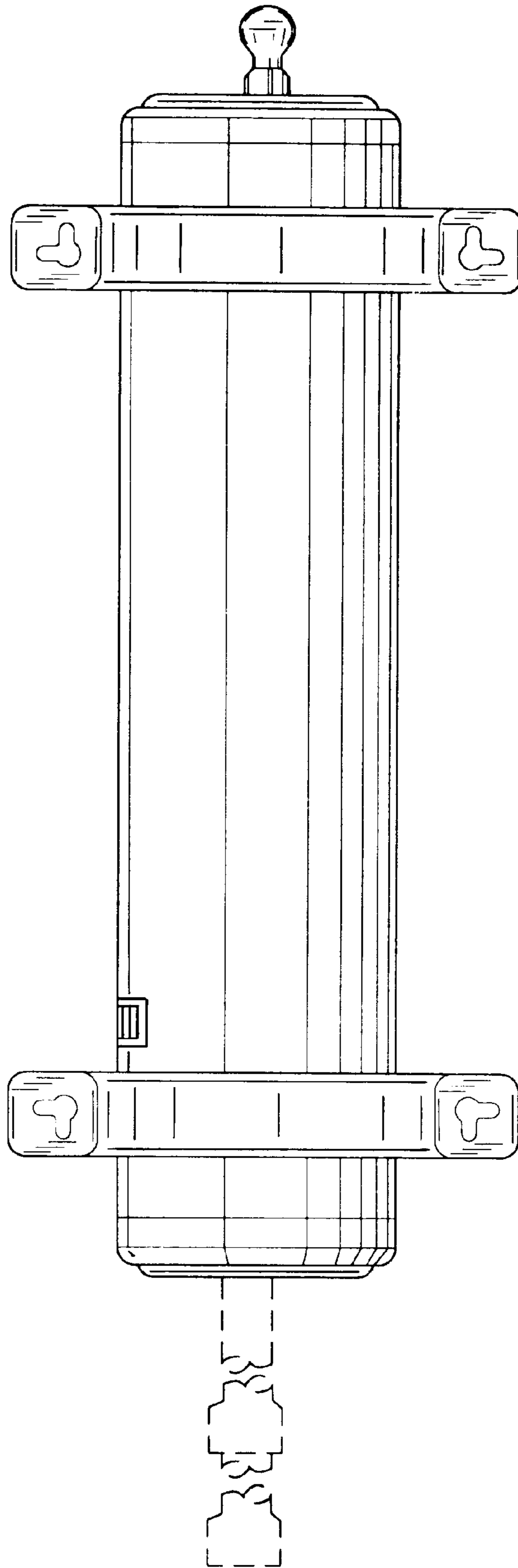

FIG. 8

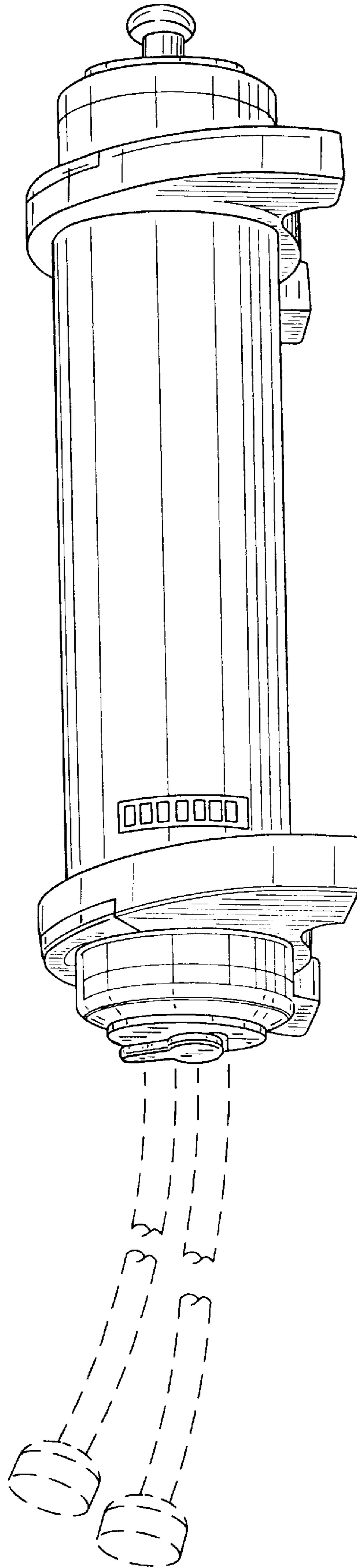

FIG. 9

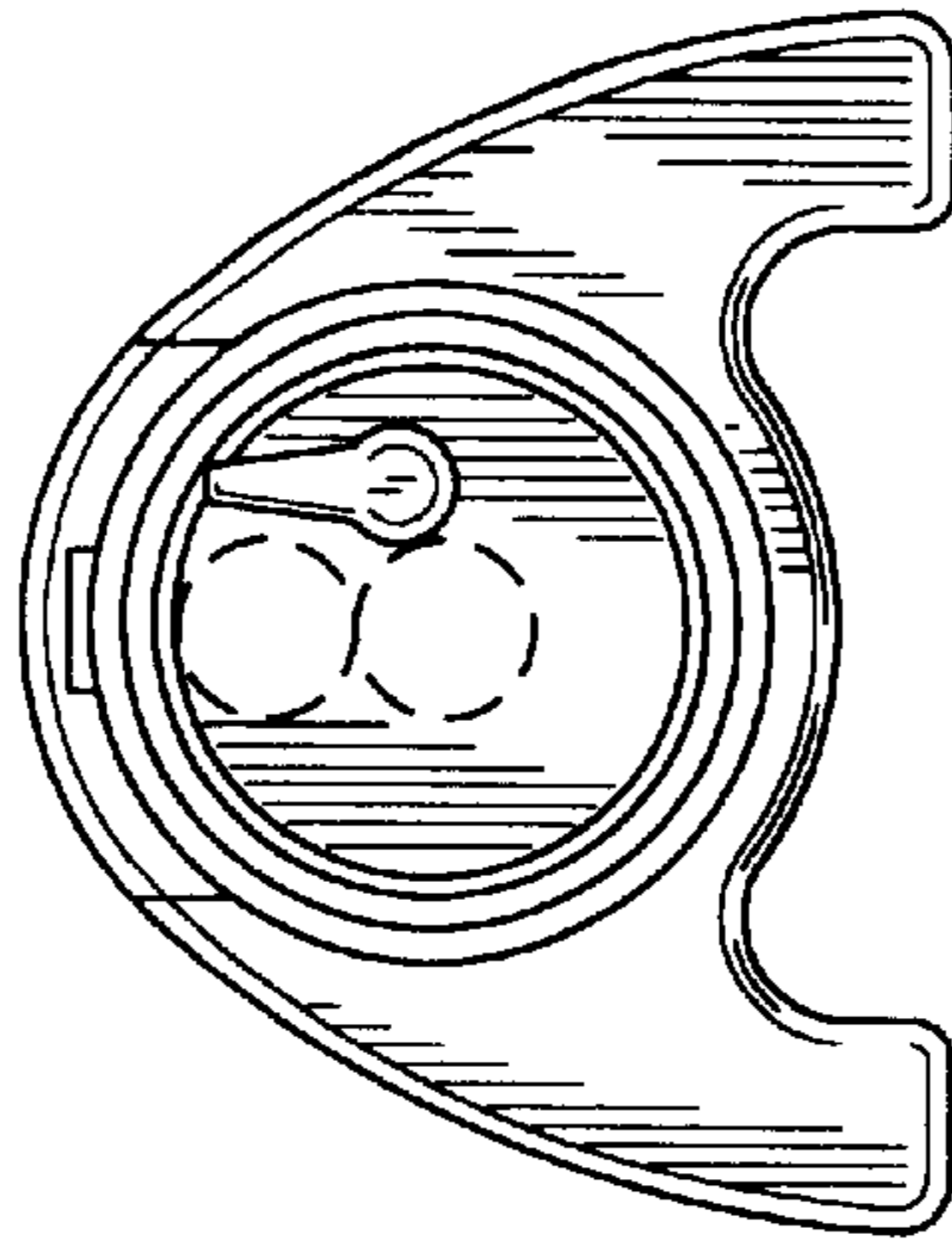

FIG. 10

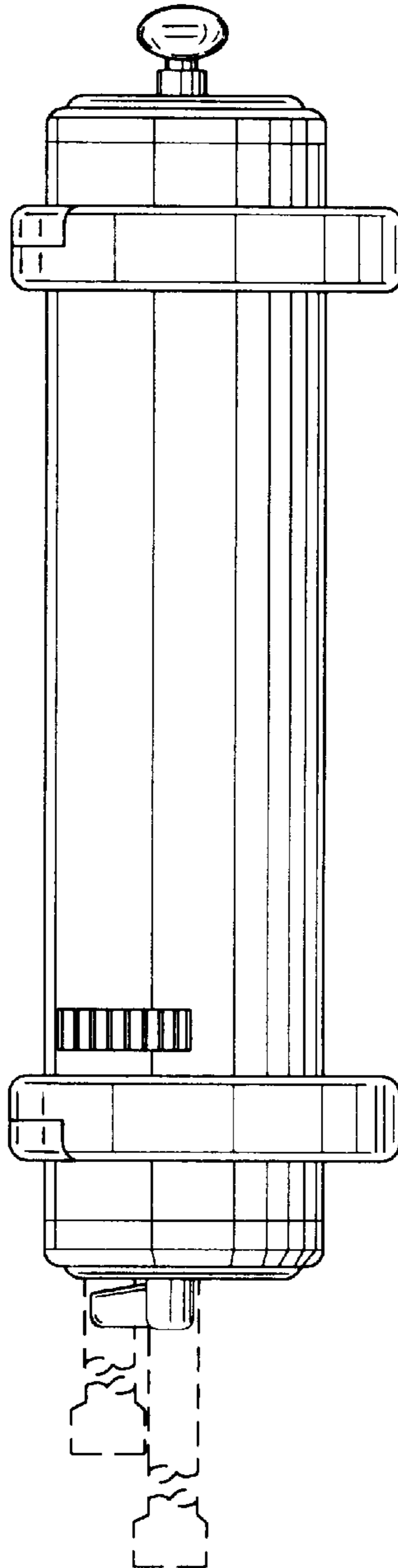

FIG. 12

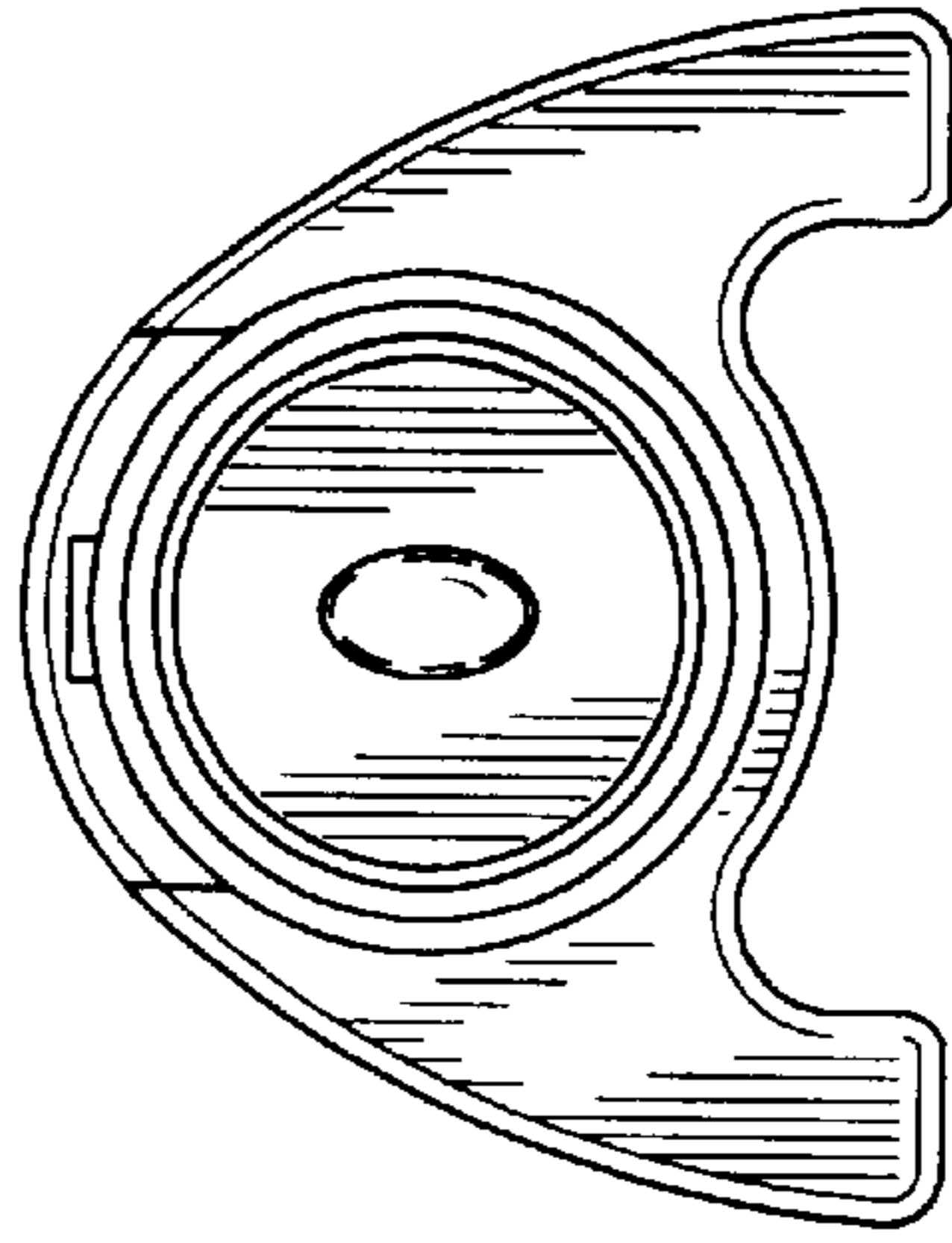

FIG. 11

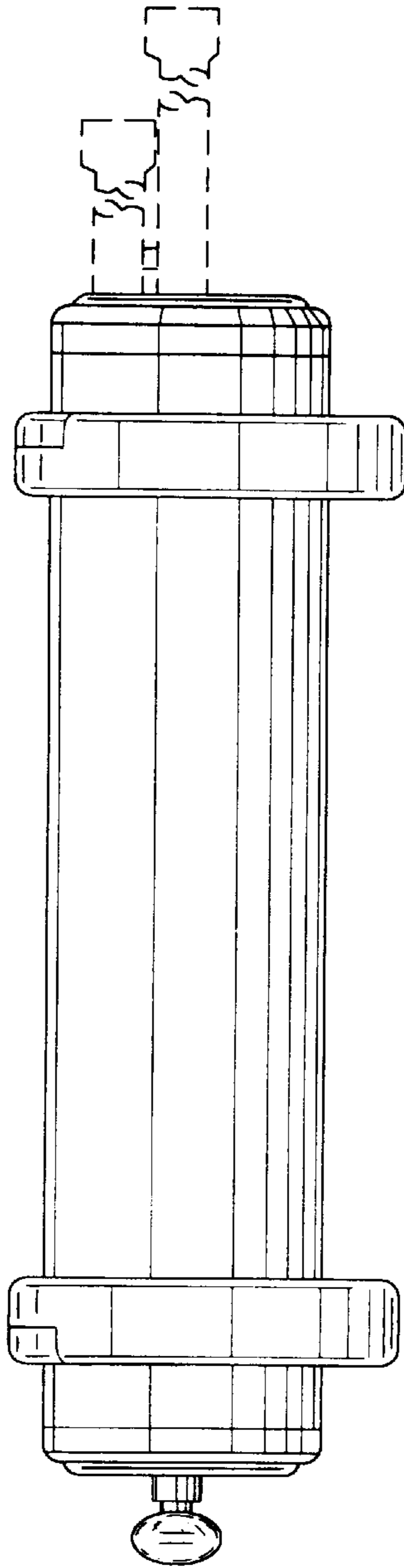

FIG. 13

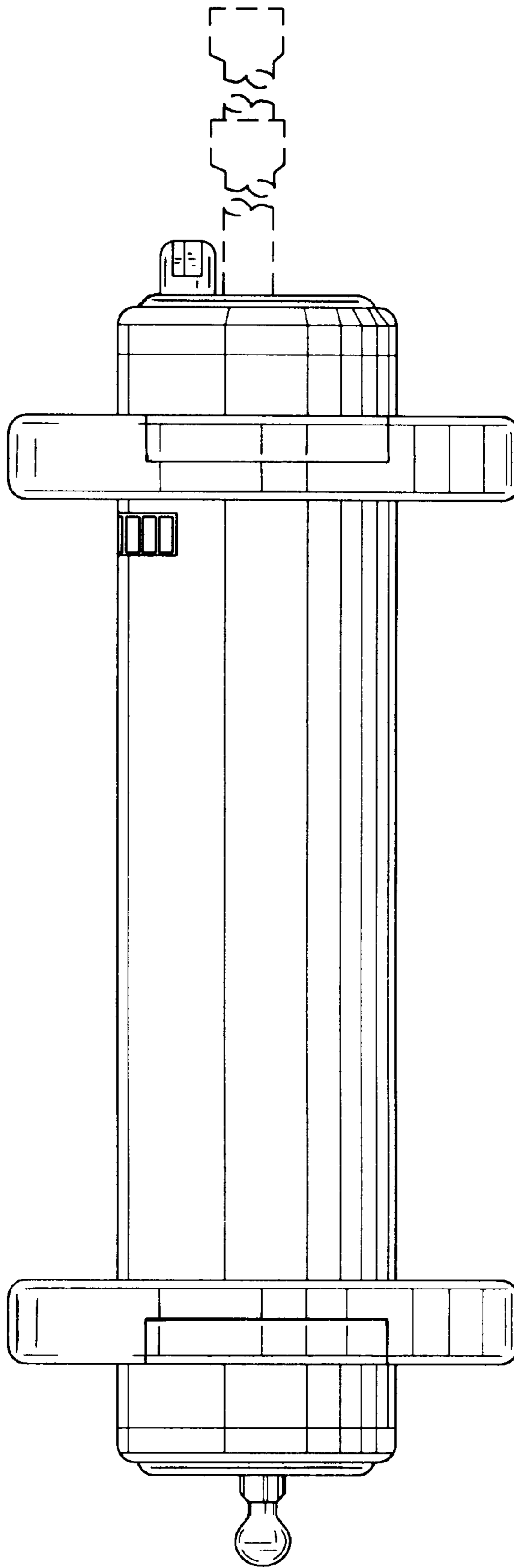

FIG. 14

