



US00D416295S

United States Patent [19] Choi

[11] **Patent Number: Des. 416,295**

[45] **Date of Patent: ** Nov. 9, 1999**

[54] **TOY SWORD**

[75] Inventor: **Chung-Hing Choi**, Kowloon, The Hong Kong Special Administrative Region of the People's Republic of China

[73] Assignee: **Hing Fat Toys Manufacturer Limited**, The Hong Kong Special Administrative Region of the People's Republic of China

[**] Term: **14 Years**

[21] Appl. No.: **29/081,422**

[22] Filed: **Jan. 2, 1998**

[51] **LOC (6) Cl.** **21-01**

[52] **U.S. Cl.** **D21/568**

[58] **Field of Search** D21/567, 568; D22/118; D3/12; 446/405, 406, 473; 482/12, 83; 30/295, 340, 346

[56] **References Cited**

U.S. PATENT DOCUMENTS

D. 221,335 8/1971 Clayton D22/118

D. 330,064 10/1992 Medina D22/118
D. 397,171 8/1998 Choi D21/568
D. 399,891 10/1998 Choi D21/568

Primary Examiner—Raphael Barkai
Attorney, Agent, or Firm—Samuels, Gauthier & Stevens

[57] **CLAIM**

The ornamental design for a “toy sword”, as shown and described.

DESCRIPTION

FIG. 1 is the front perspective view showing my new design; FIG. 2 is the front view thereof; FIG. 3 is the rear view thereof; FIG. 4 is the left-hand view thereof; FIG. 5 is the right-hand view thereof; FIG. 6 is the top view thereof; and, FIG. 7 is the bottom view thereof.

The broken lines shown in FIGS. 1–5 is for illustrative purposes only and form no part of the claimed design.

1 Claim, 4 Drawing Sheets

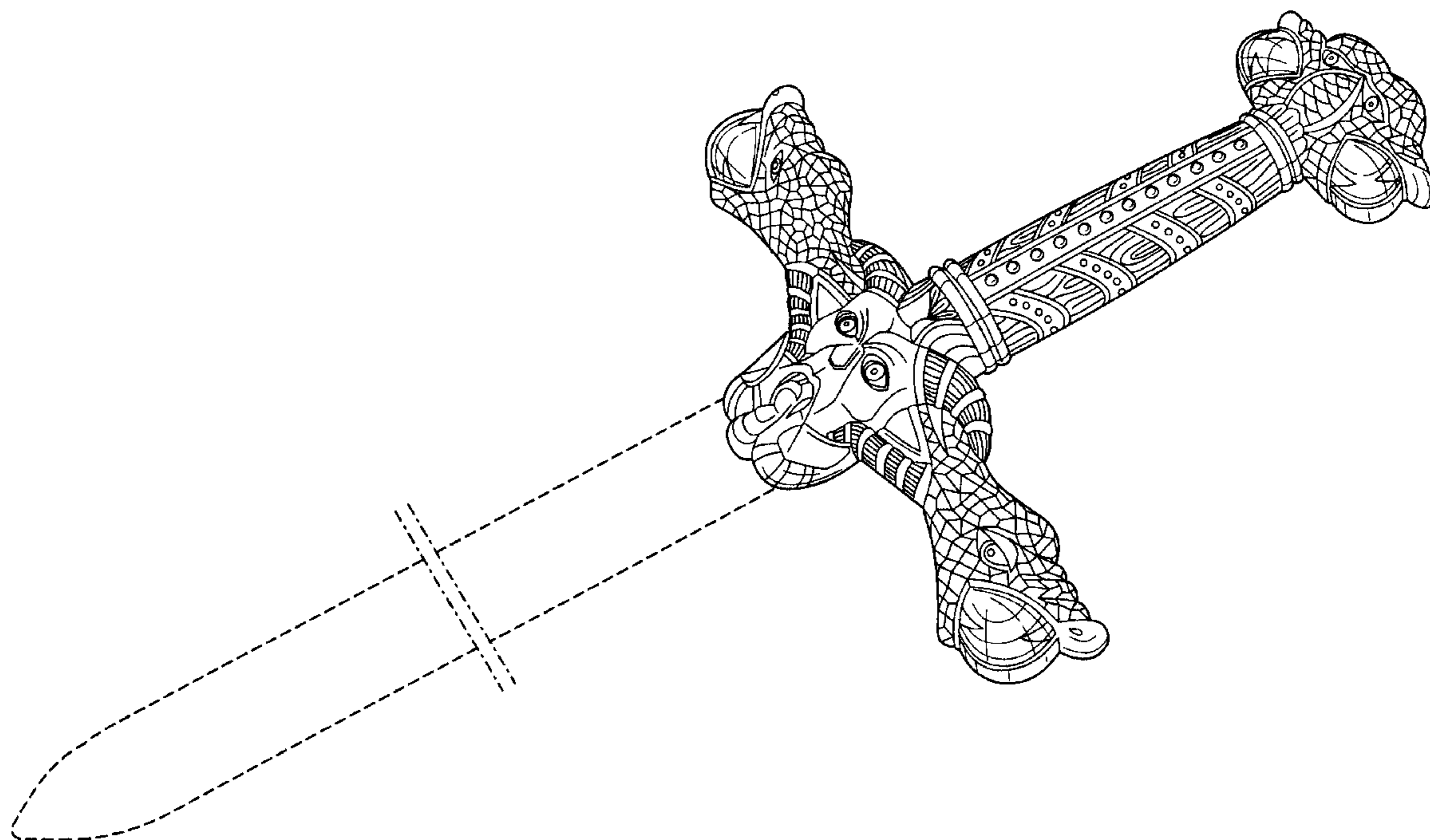

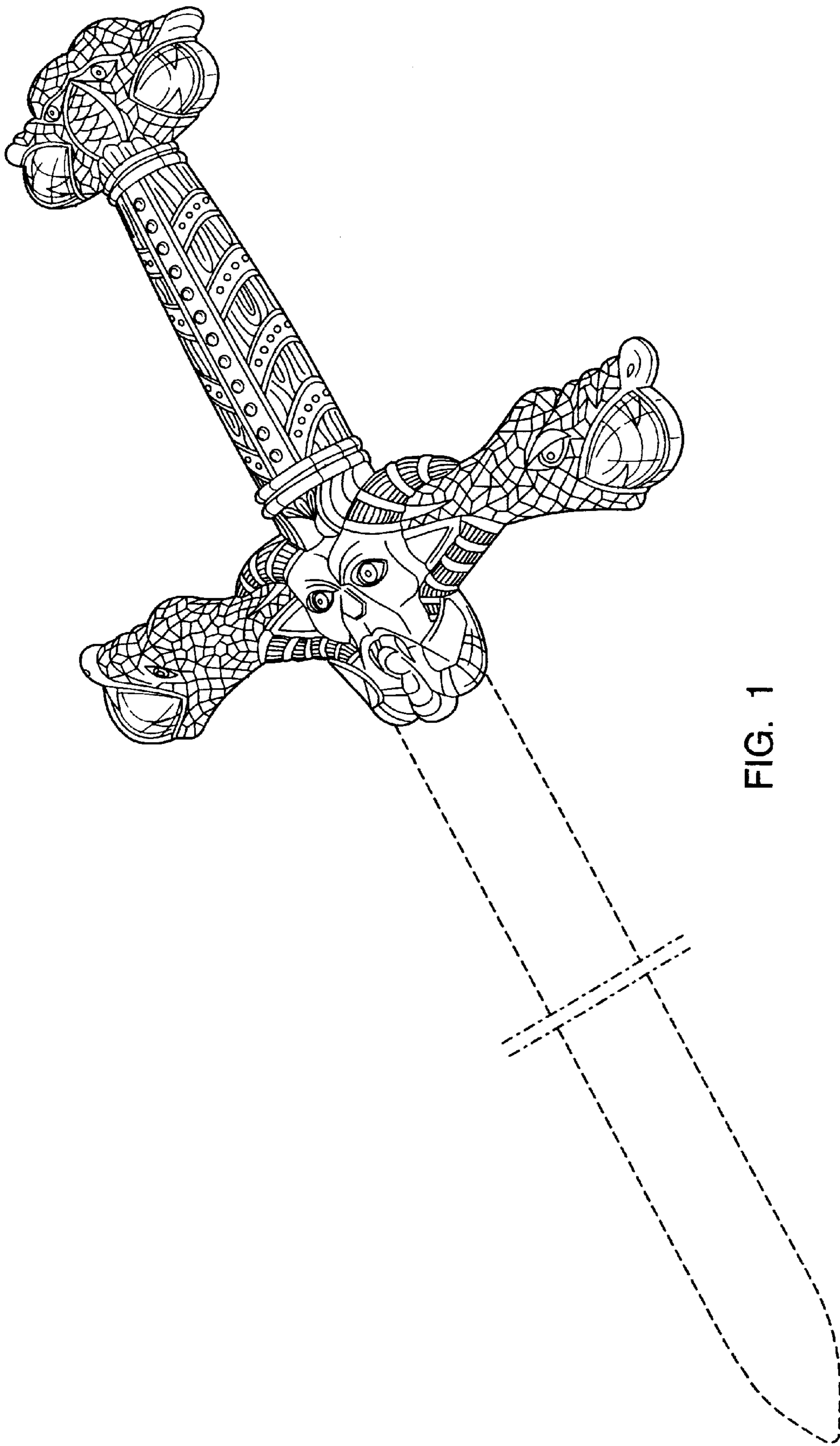

FIG. 1

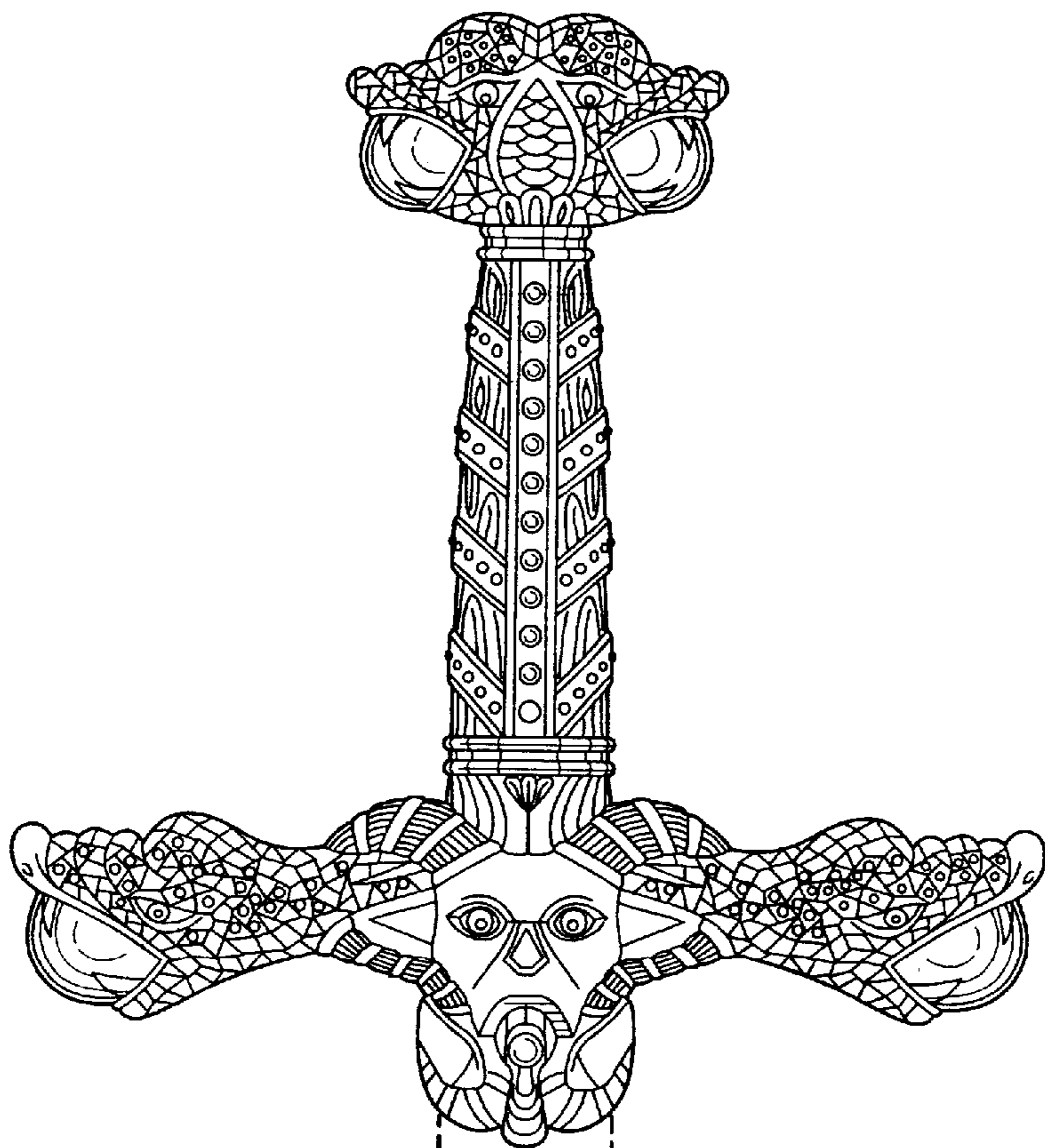

FIG. 2

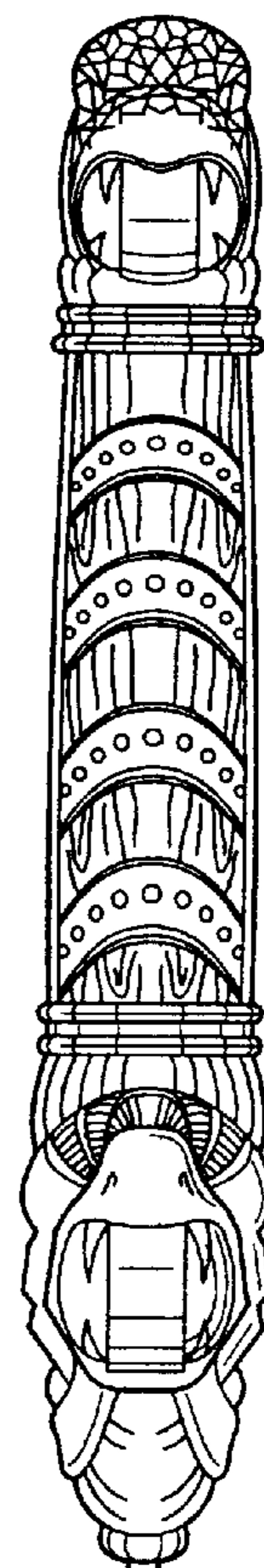

FIG. 4

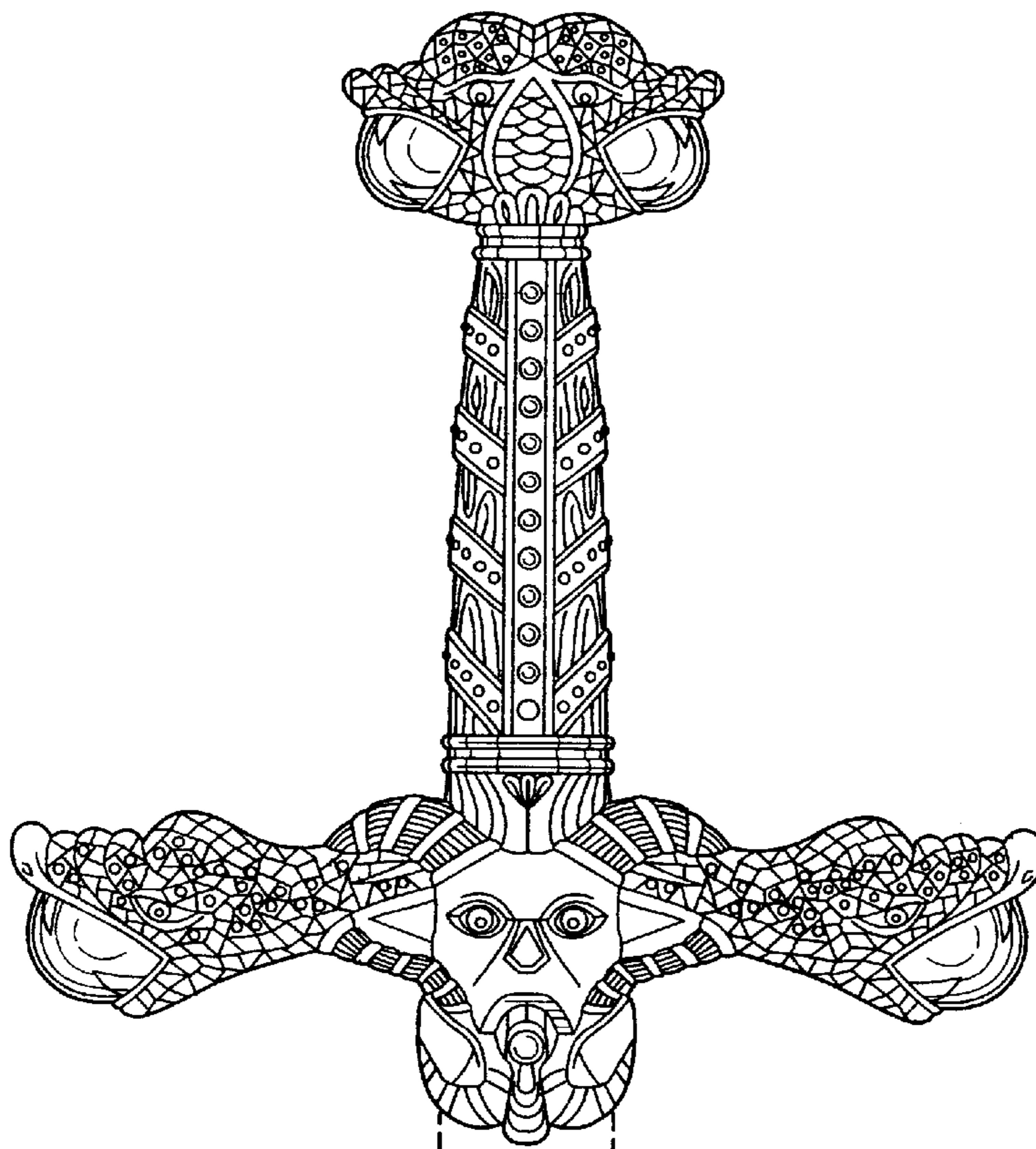

FIG. 3

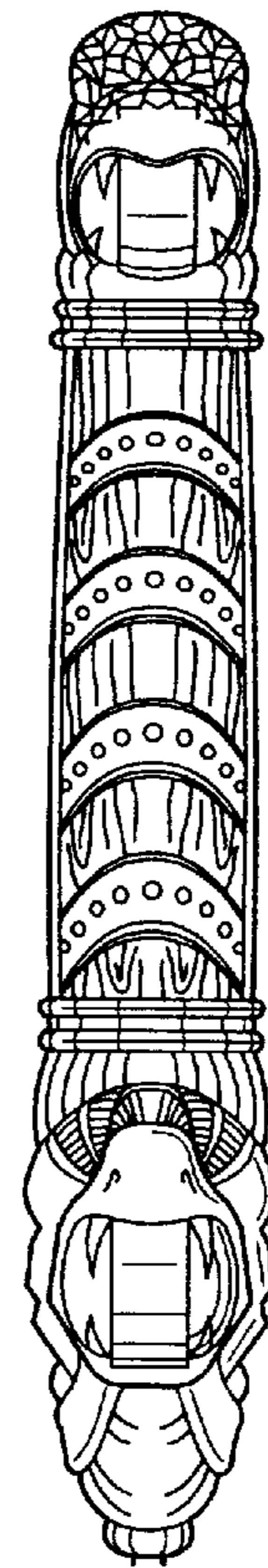

FIG. 5

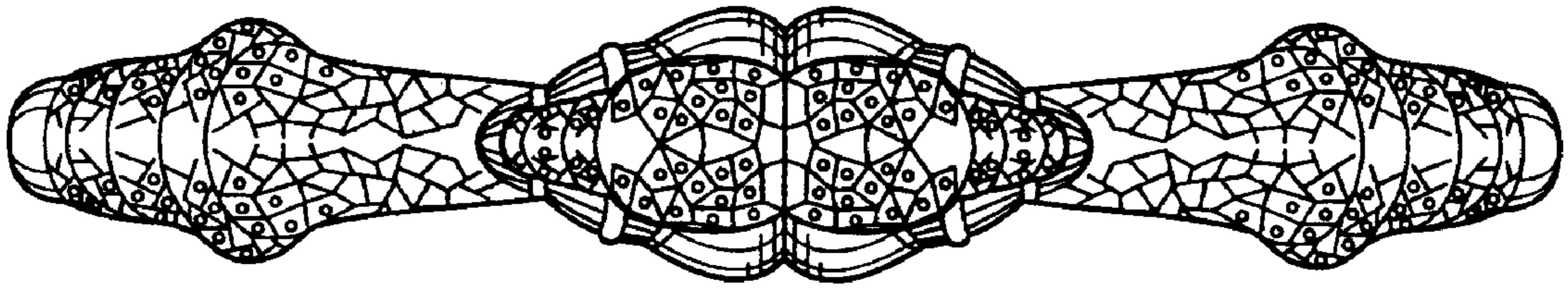

FIG. 6

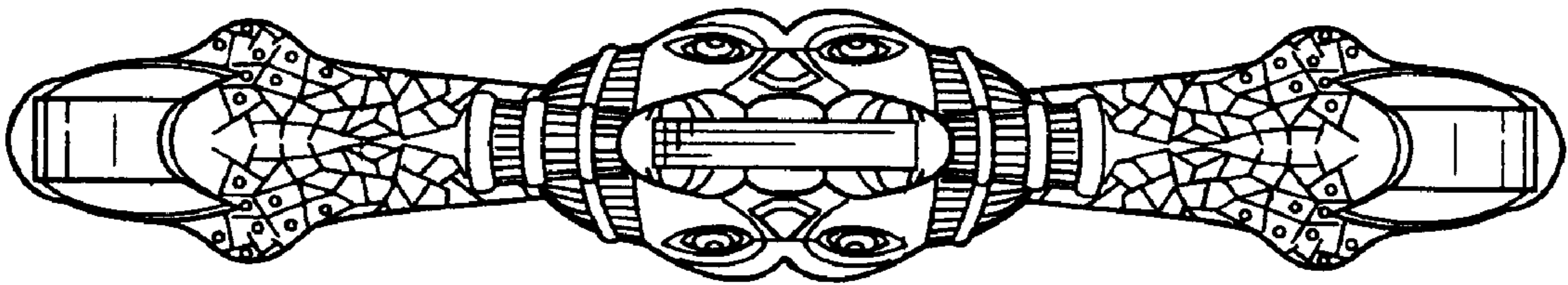

FIG. 7