



US00D416291S

# United States Patent [19] Sugino

[11] **Patent Number: Des. 416,291**

[45] **Date of Patent: \*\* Nov. 9, 1999**

[54] **HAND HELD ELECTRIC GAME**

[75] Inventor: **Kenichi Sugino**, Kyoto, Japan

[73] Assignee: **Nintendo Co., Ltd.**, Japan

[\*\*] Term: **14 Years**

[21] Appl. No.: **29/094,217**

[22] Filed: **Sep. 28, 1998**

[30] **Foreign Application Priority Data**

Mar. 27, 1998	[JP]	Japan	.....	10-8813
May 21, 1998	[JP]	Japan	.....	10-14749

[51] **LOC (6) Cl.** ..... **21-01**

[52] **U.S. Cl.** ..... **D21/329**

[58] **Field of Search** ..... D21/324, 328,  
D21/329, 330, 331; D14/117.1, 117.9; 273/148 B;  
463/1, 29-35, 46, 47

[56] **References Cited**

**U.S. PATENT DOCUMENTS**

D. 318,884	8/1991	Kojo	.....	D21/329
D. 320,624	10/1991	Taylor	.....	D21/331
D. 353,631	12/1994	Dudley et al.	.....	D21/329
D. 357,507	4/1995	Chen et al.	.....	D21/324
D. 362,692	9/1995	Rissman et al.	.....	D21/329
D. 400,596	11/1998	Keung et al.	.....	D21/329
5,184,830	2/1993	Okada et al.	.....	463/29
5,213,327	5/1993	Kitaue	.....	463/38
5,217,295	6/1993	Tortola t al.	.....	362/109
5,232,223	8/1993	Dorn Busch	.....	463/37

**OTHER PUBLICATIONS**

Hong Kong Enterprise, p. 324, Oct. 1996.

*Primary Examiner*—Prabhakar Deshmukh  
*Attorney, Agent, or Firm*—Nixon & Vanderhye P.C.

[57] **CLAIM**

The ornamental design for a “hand held electronic game”, as shown and described.

**DESCRIPTION**

FIG. 1 is a front elevation view of the hand held electronic game in accordance with a first embodiment of my new design;

FIG. 2 is a left side view thereof;

FIG. 3 is a right side view thereof;

FIG. 4 is a plan view thereof;

FIG. 5 is a bottom view thereof;

FIG. 6 is a rear view thereof;

FIG. 7 is an upper right front perspective view thereof;

FIG. 8 is a lower left front perspective view thereof;

FIG. 9 is a front elevation view of the hand held electronic game in accordance with a second embodiment of my new design;

FIG. 10 is a left side view thereof;

FIG. 11 is a right side view thereof;

FIG. 12 is a plan view thereof;

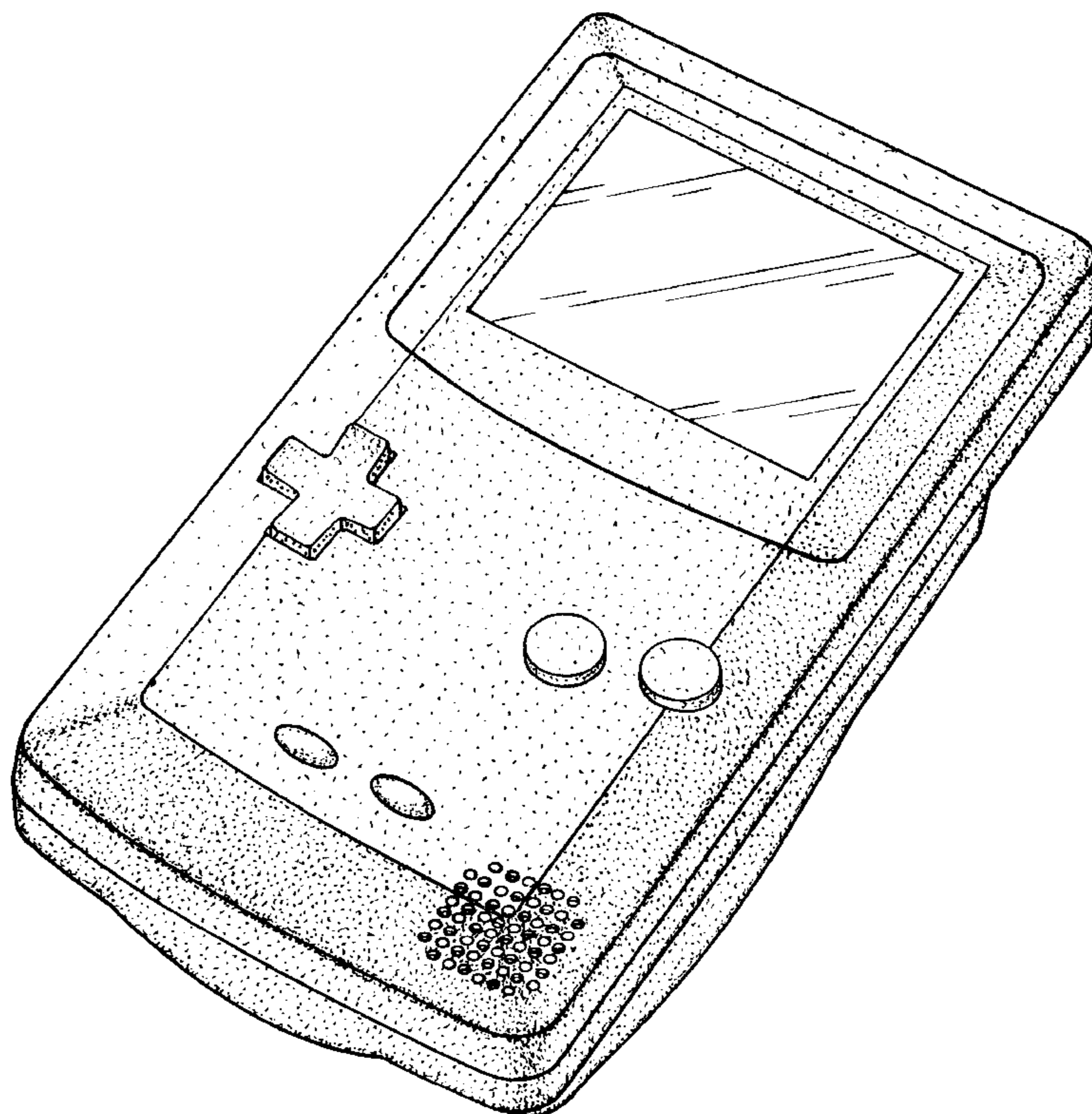
FIG. 13 is a bottom view thereof;

FIG. 14 is a rear view thereof;

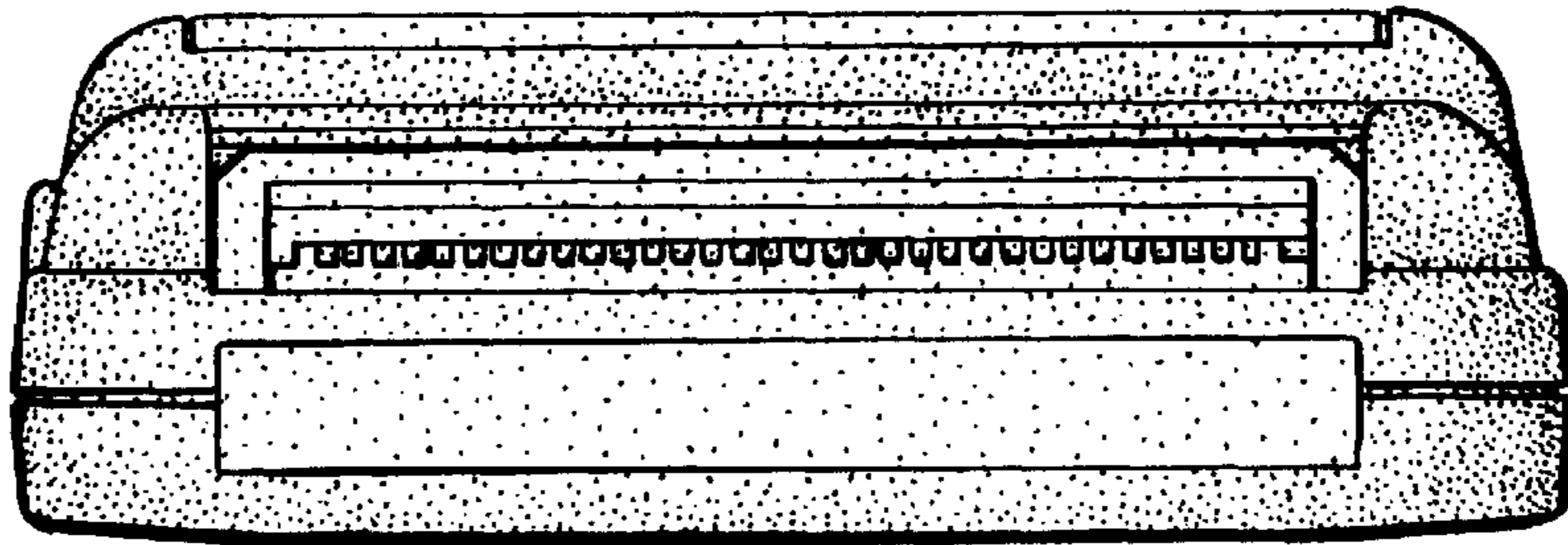
FIG. 15 is an upper right front perspective view thereof; and,

FIG. 16 is a lower left front perspective view thereof.

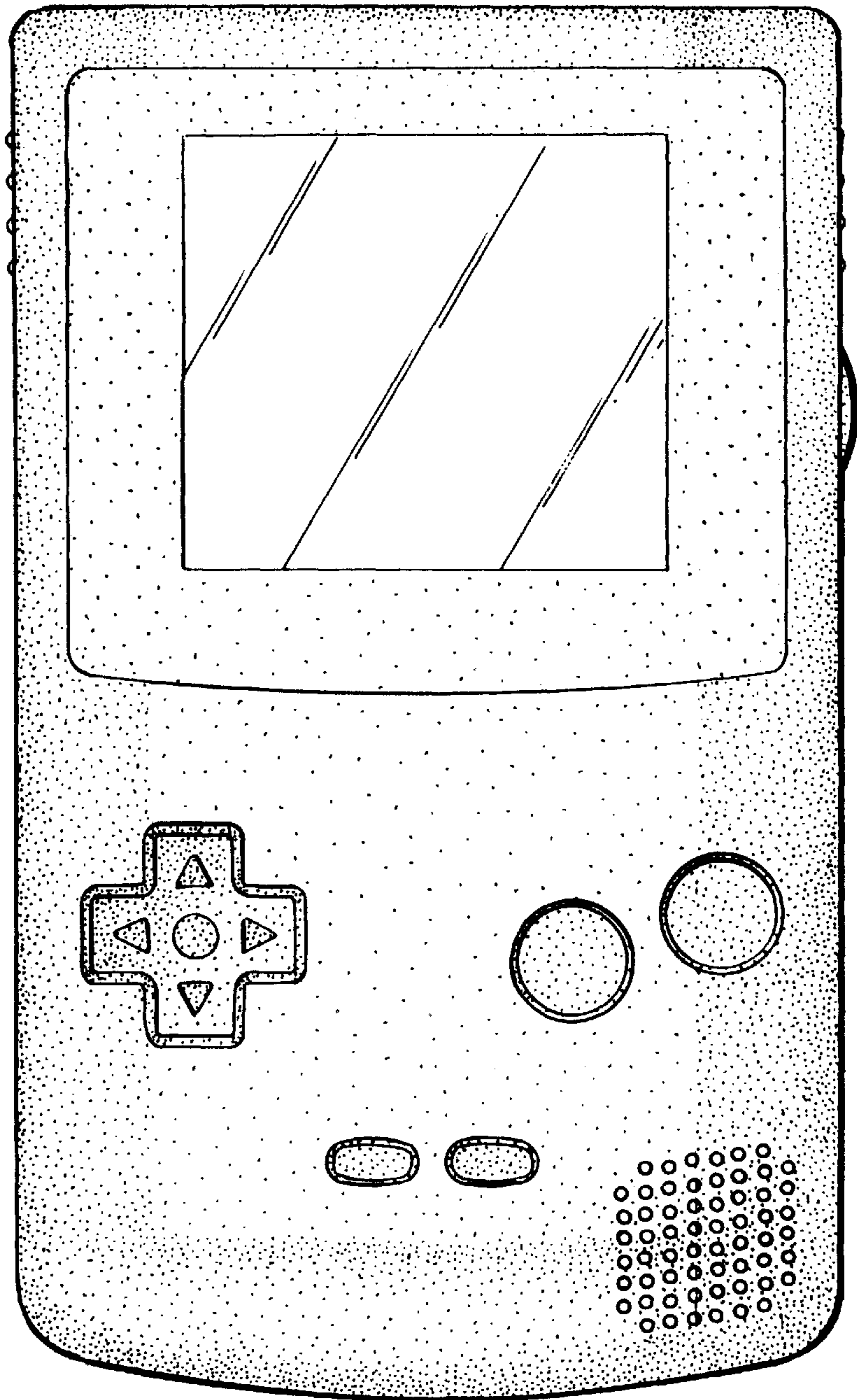
**1 Claim, 10 Drawing Sheets**



**Fig. 4**

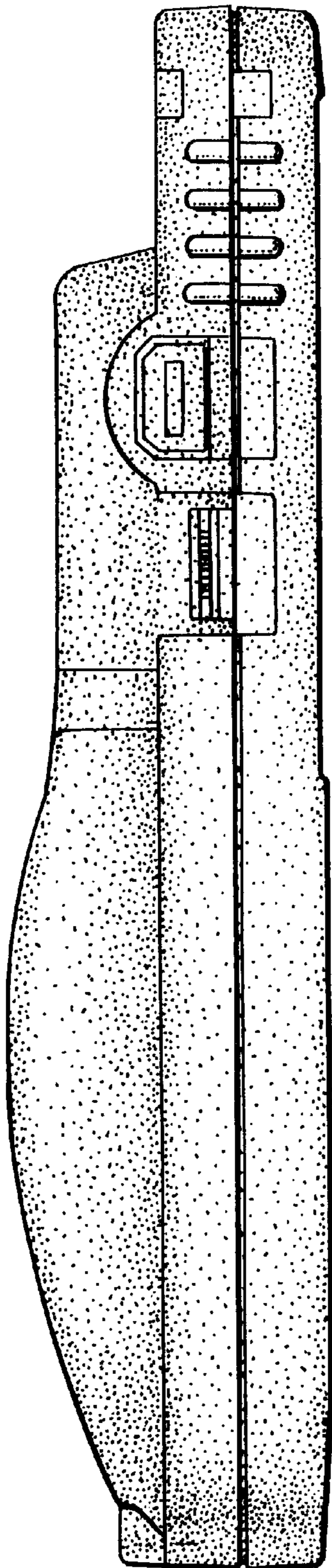


**Fig. 1**

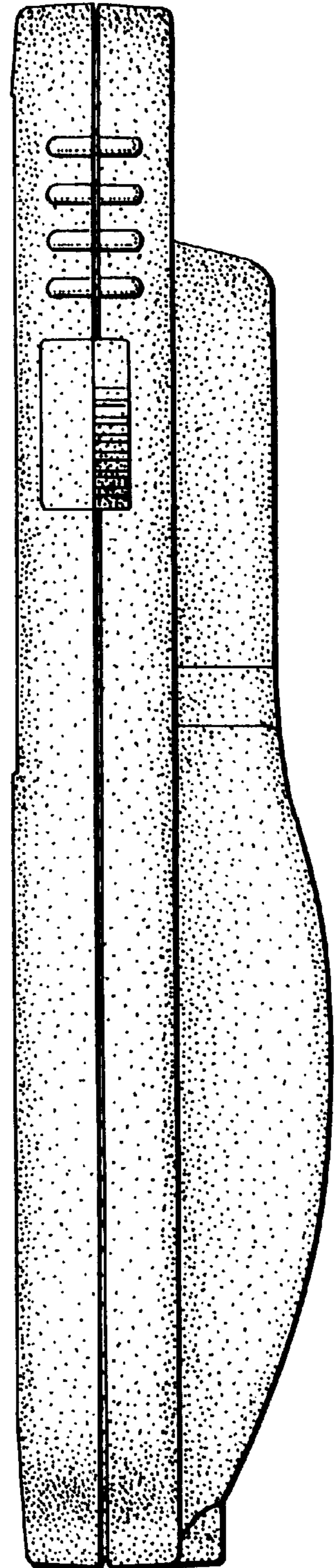




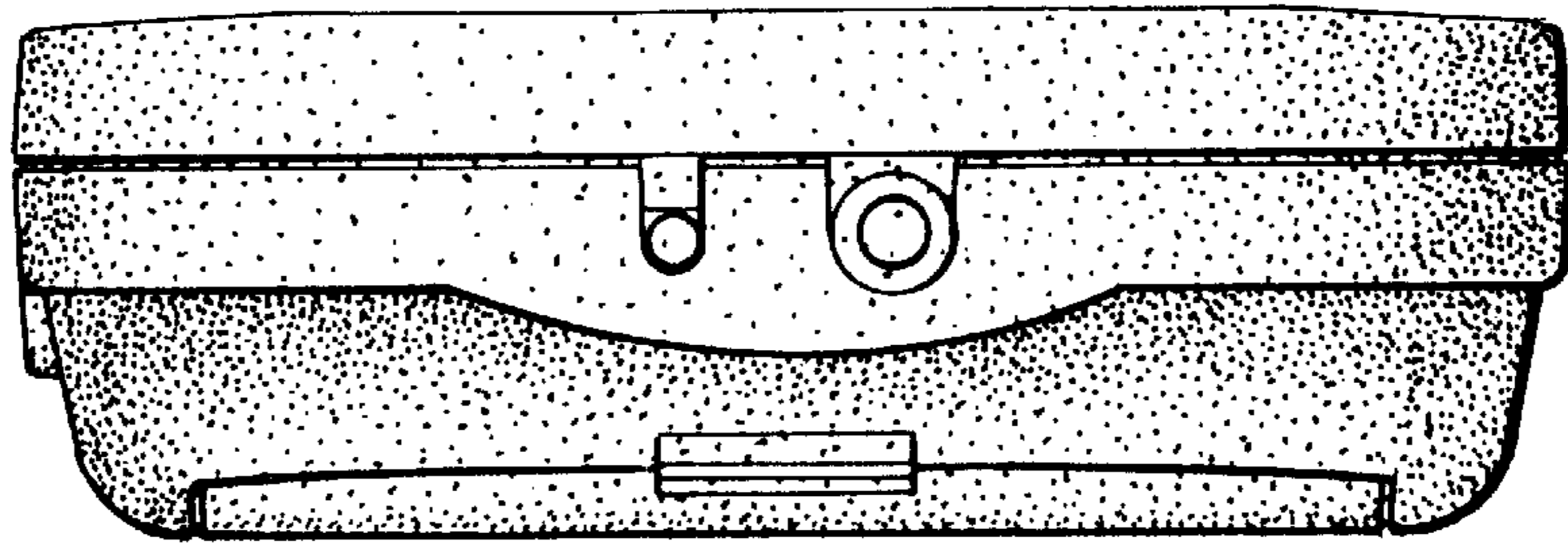
**Fig. 2**



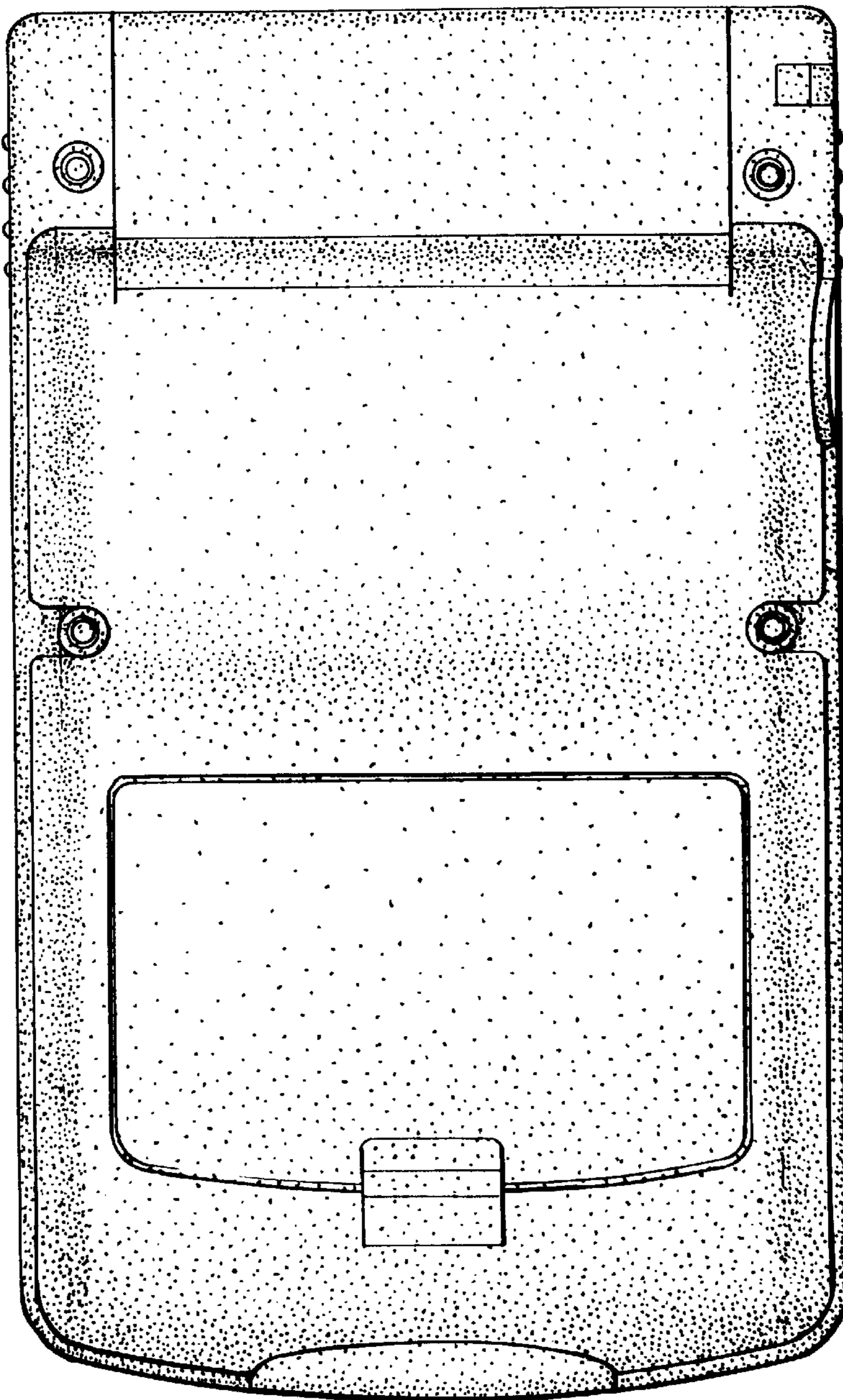
**Fig. 3**



**Fig. 5**

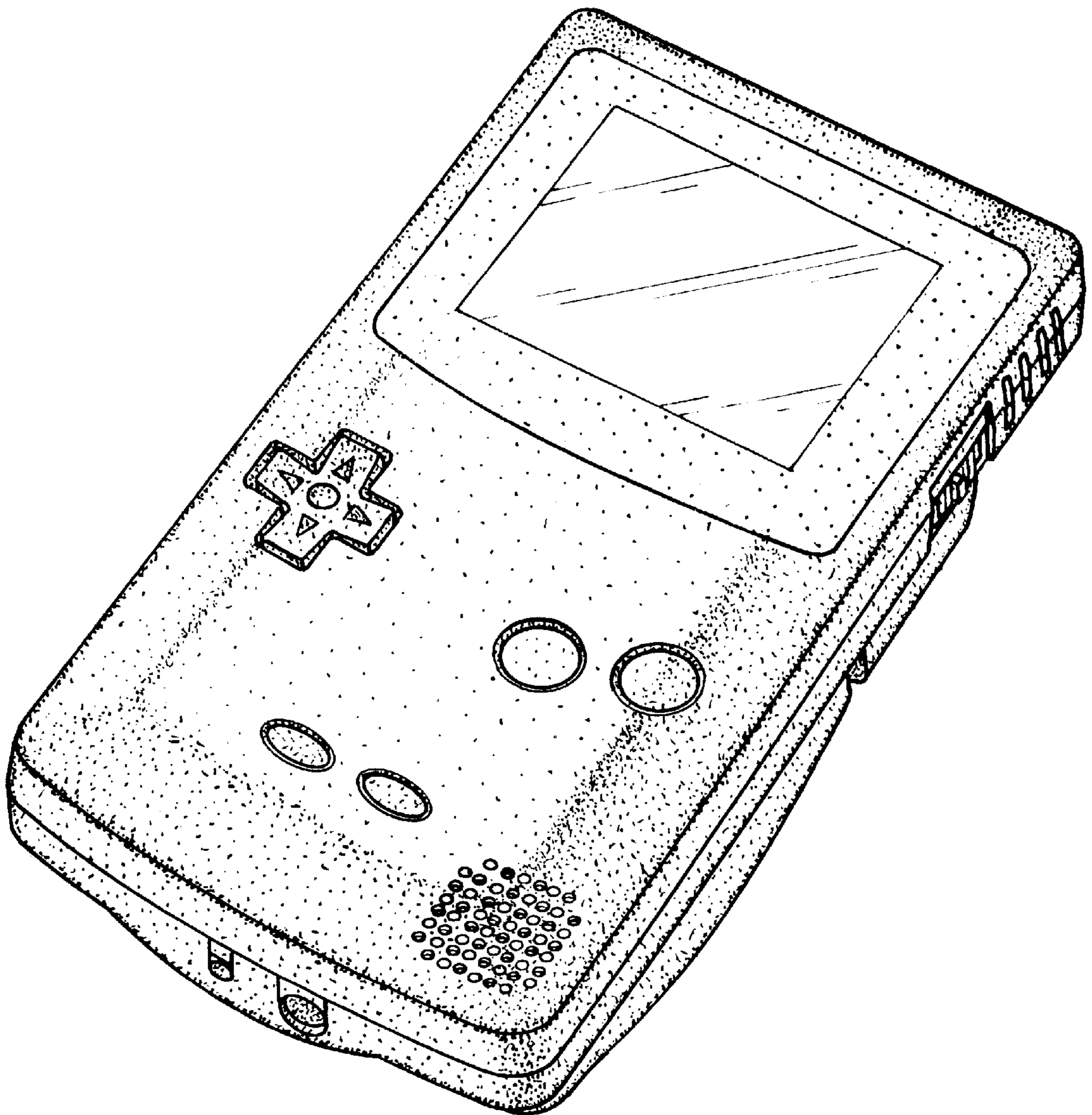


**Fig. 6**

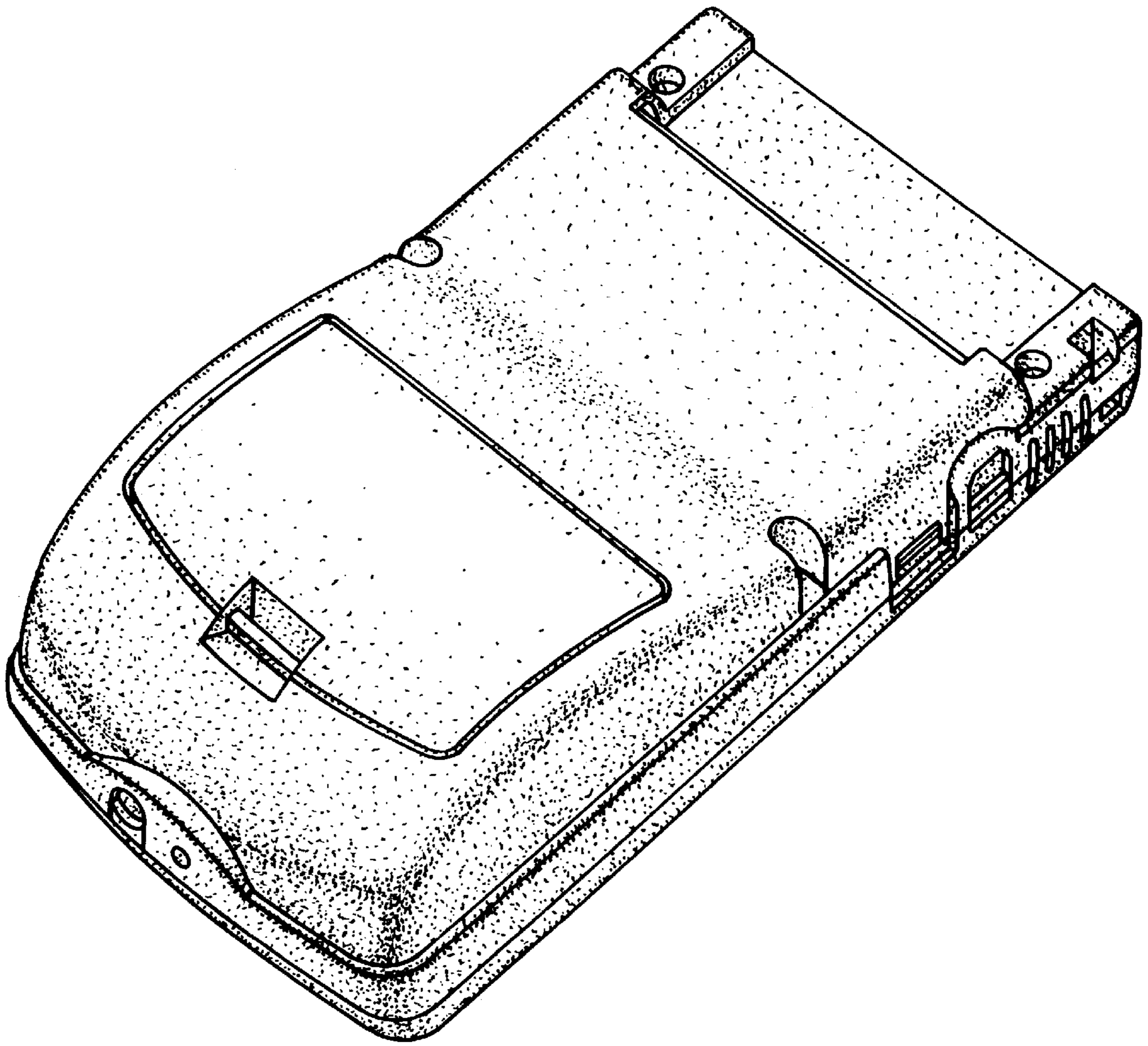




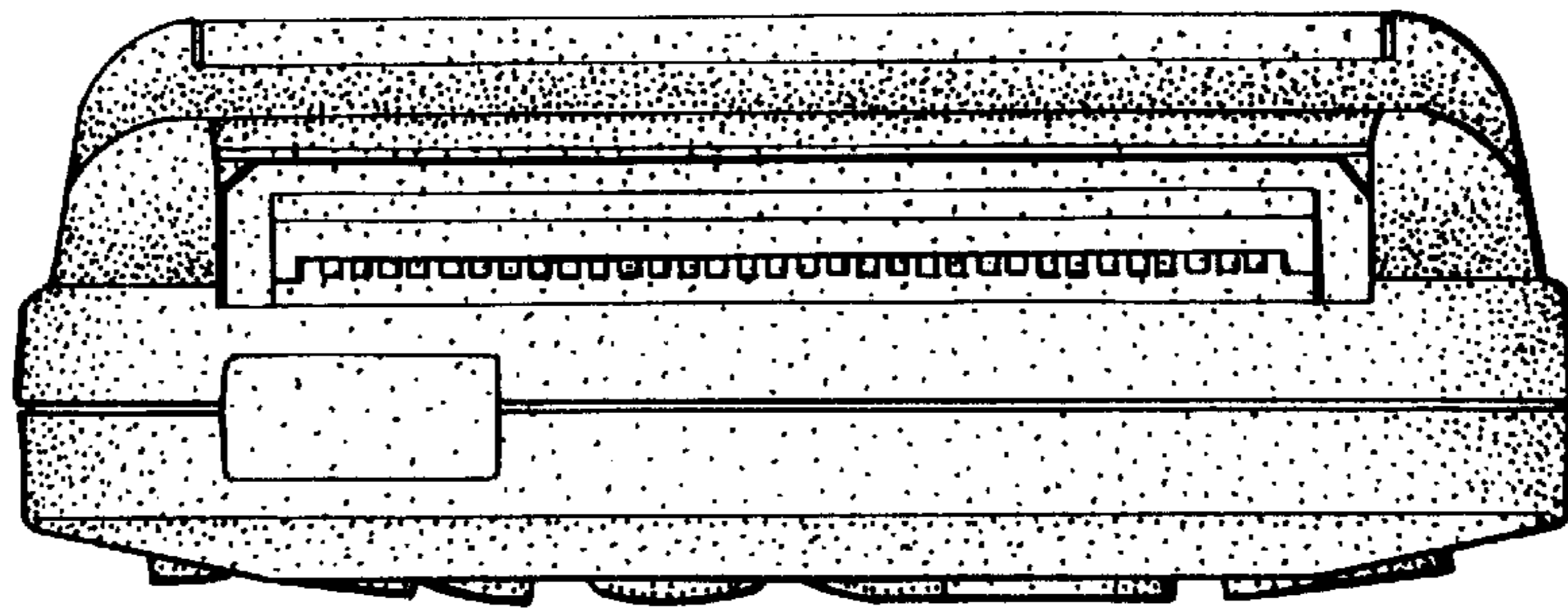
**Fig. 7**



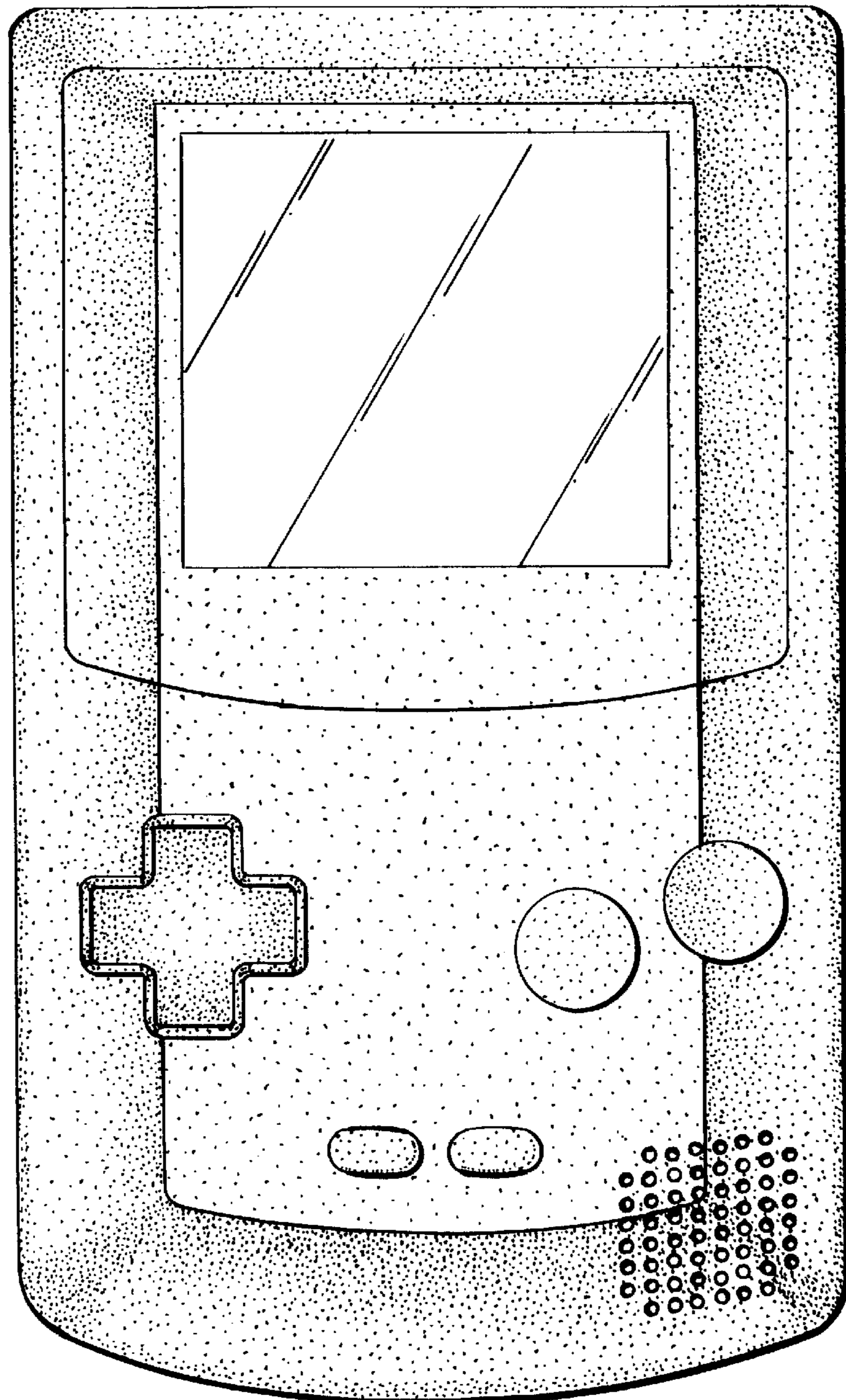
**Fig. 8**



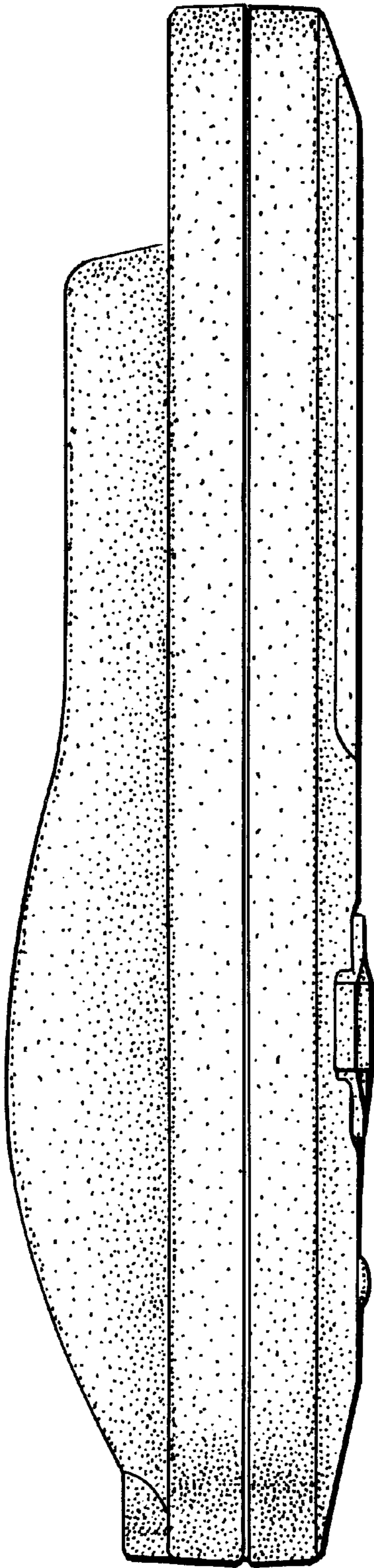
**Fig. 12**



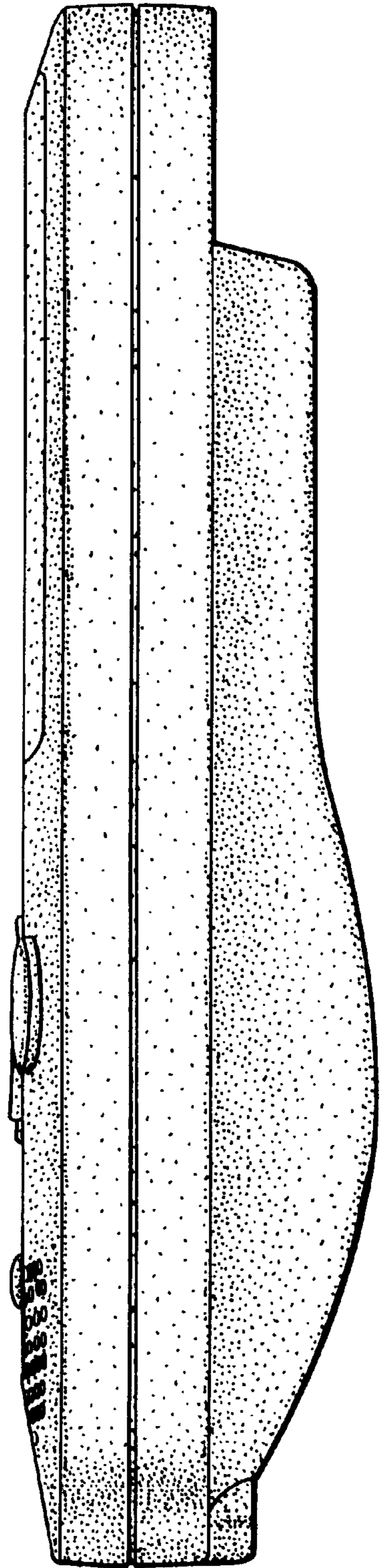
**Fig. 9**







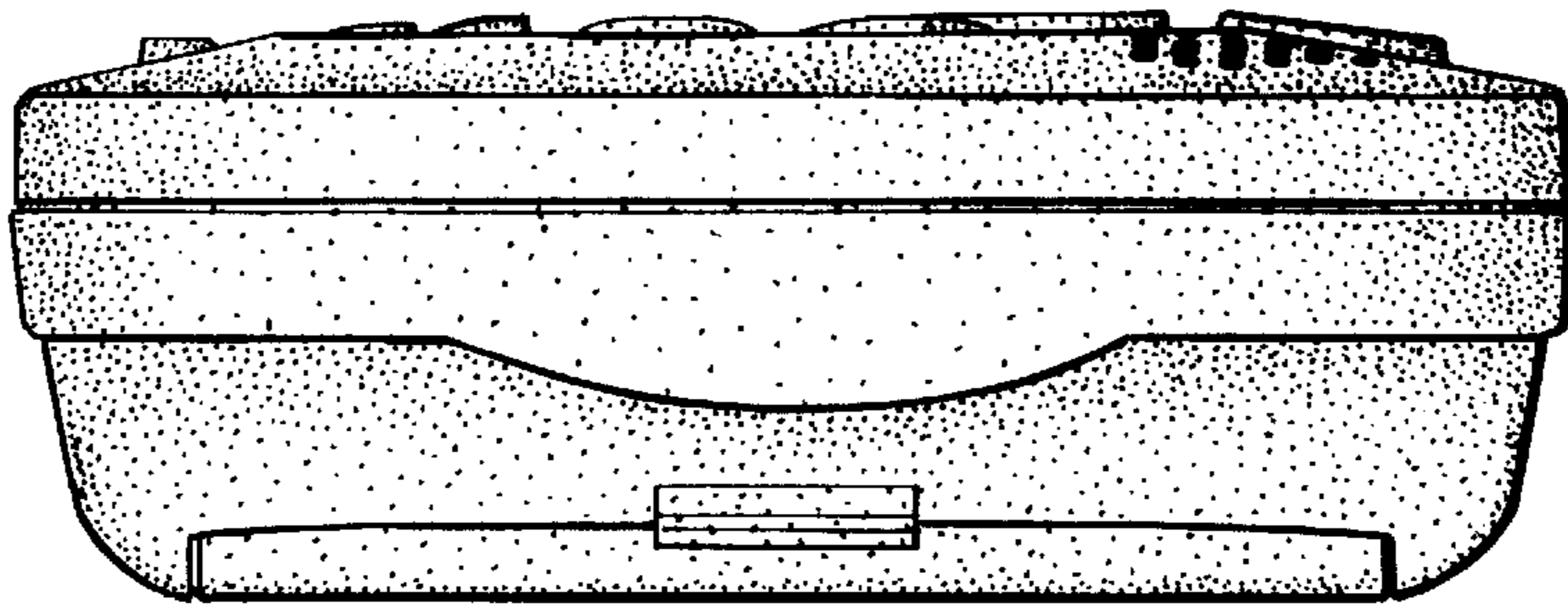
**Fig. 10**



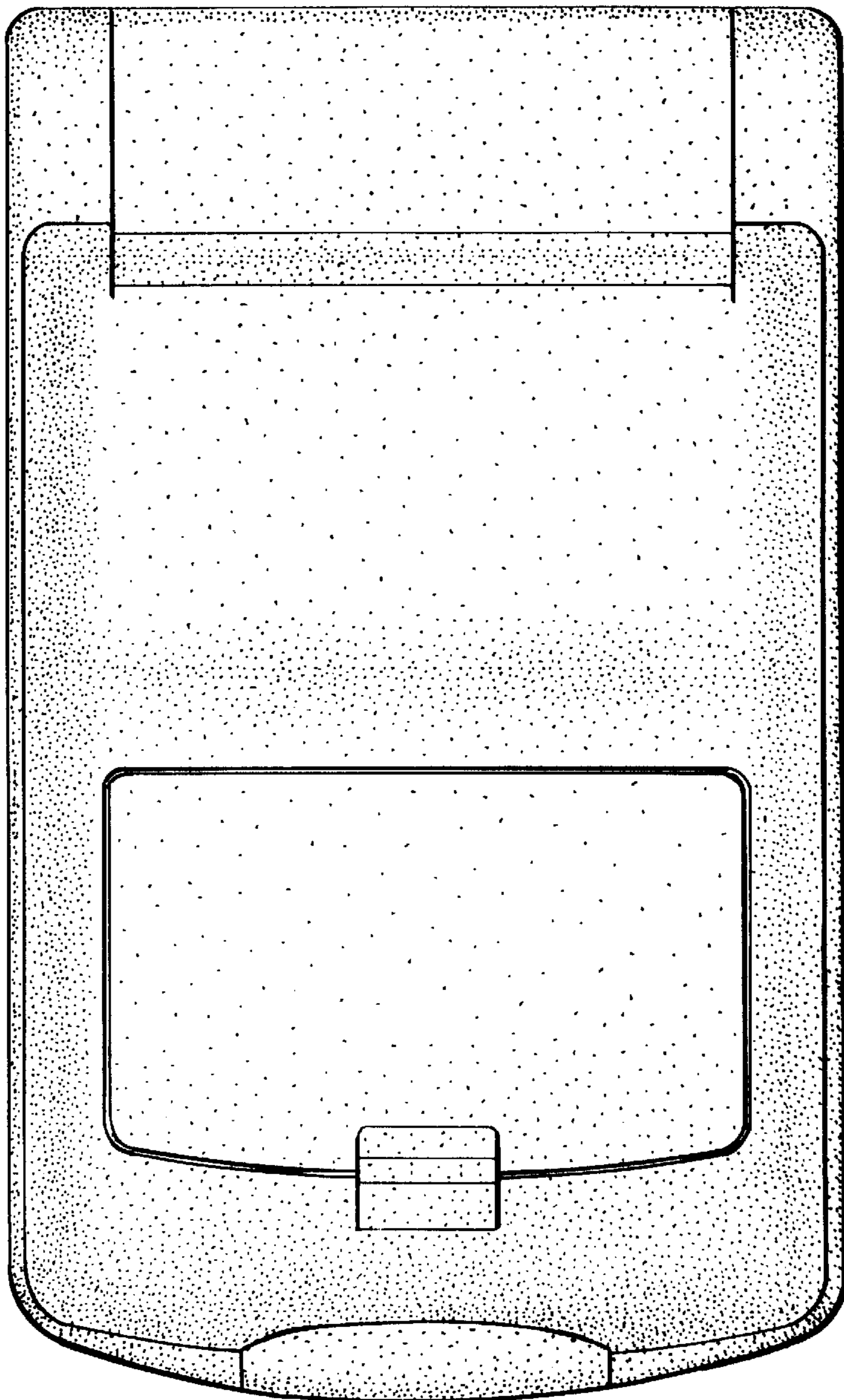
**Fig. 11**



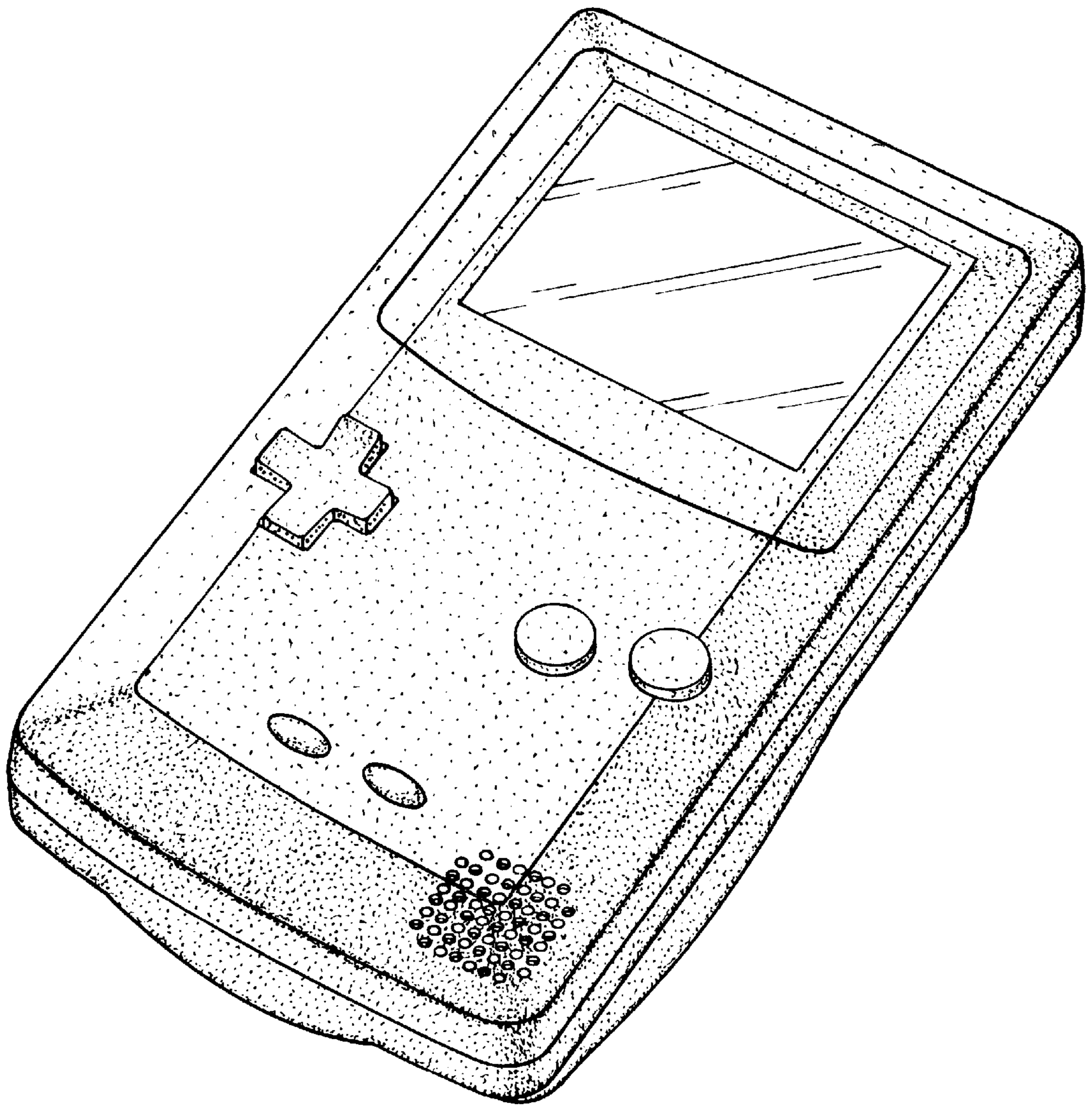
**Fig. 13**



**Fig. 14**



**Fig. 15**





**Fig. 16**

