



US00D416267S

**United States Patent** [19]  
**Reilly**

[11] **Patent Number: Des. 416,267**

[45] **Date of Patent: \*\* Nov. 9, 1999**

[54] **WIRE NUT TIGHTENING DRILL BIT**

[57] **CLAIM**

[76] Inventor: **Baron Reilly**, 3281 Old 6th Ave.,  
Duncansville, Pa. 16635

The ornamental design for a wire nut tightening drill bit, as shown.

[\*\*] Term: **14 Years**

**DESCRIPTION**

[21] Appl. No.: **29/096,419**

FIG. 1 is a front elevational view of the wire nut tightening drill bit of the present invention;

[22] Filed: **Nov. 12, 1998**

FIG. 2 is a back elevational view of the wire nut tightening drill bit of FIG. 1;

[51] **LOC (6) Cl.** ..... **15-09**

FIG. 3 is a right side elevational view of the wire nut tightening drill bit of FIG. 1;

[52] **U.S. Cl.** ..... **D15/139; D8/70**

FIG. 4 is a left side elevational view of the wire nut tightening drill bit of FIG. 1;

[58] **Field of Search** ..... D8/70; D15/138,  
D15/139; 408/112, 17, 71, 115 B; 279/46.6,  
152

FIG. 5 is a top plan view of the wire nut tightening drill bit of FIG. 1;

[56] **References Cited**

**U.S. PATENT DOCUMENTS**

D. 384,563	10/1997	Robinson	.....	D8/70
4,296,656	10/1981	Ernst	.....	D15/139 X
5,897,273	4/1999	Barbosa et al.	.....	408/1 R

FIG. 6 is a bottom plan view of the wire nut tightening drill bit of FIG. 1; and,

FIG. 7 is a cross sectional view along line 7—7 of FIG. 5 of the wire nut tightening drill bit of FIG. 1.

*Primary Examiner*—Antoine Duval Davis

**1 Claim, 4 Drawing Sheets**

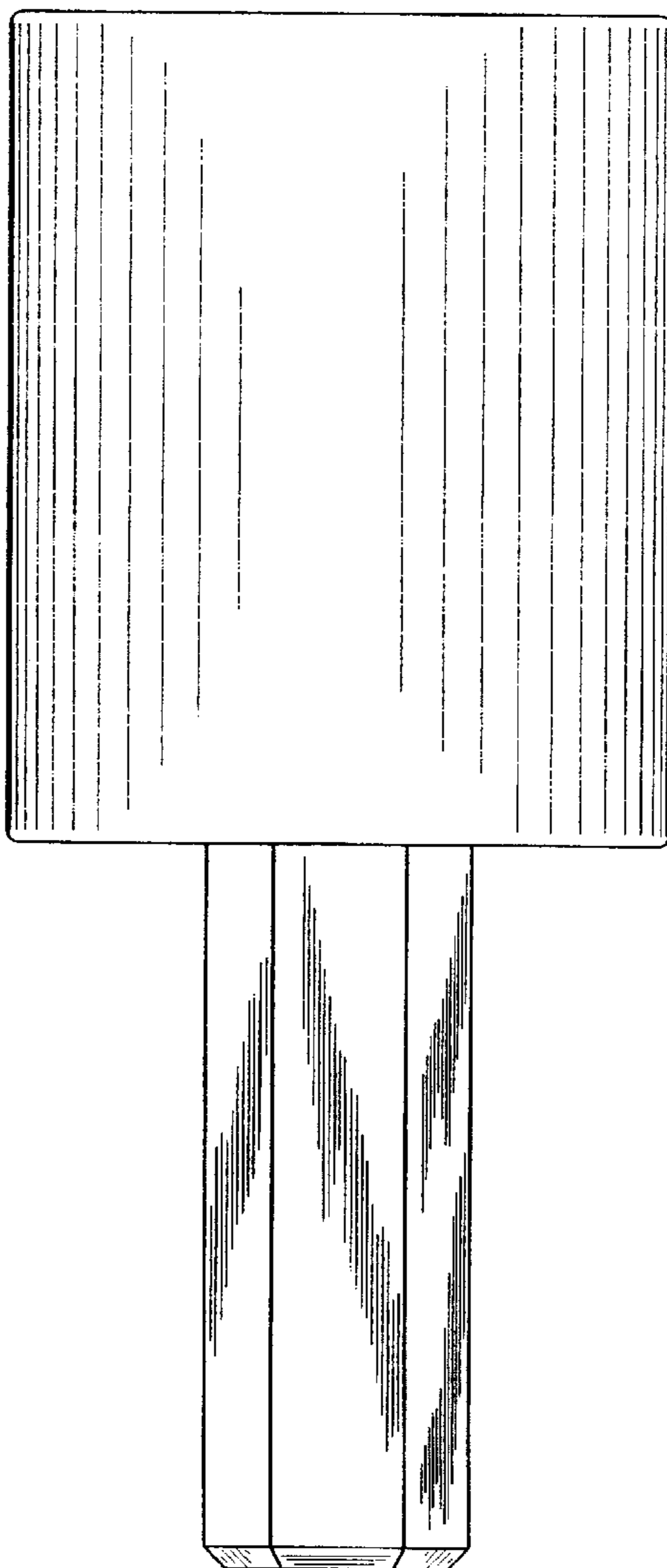

*FIG. 1*

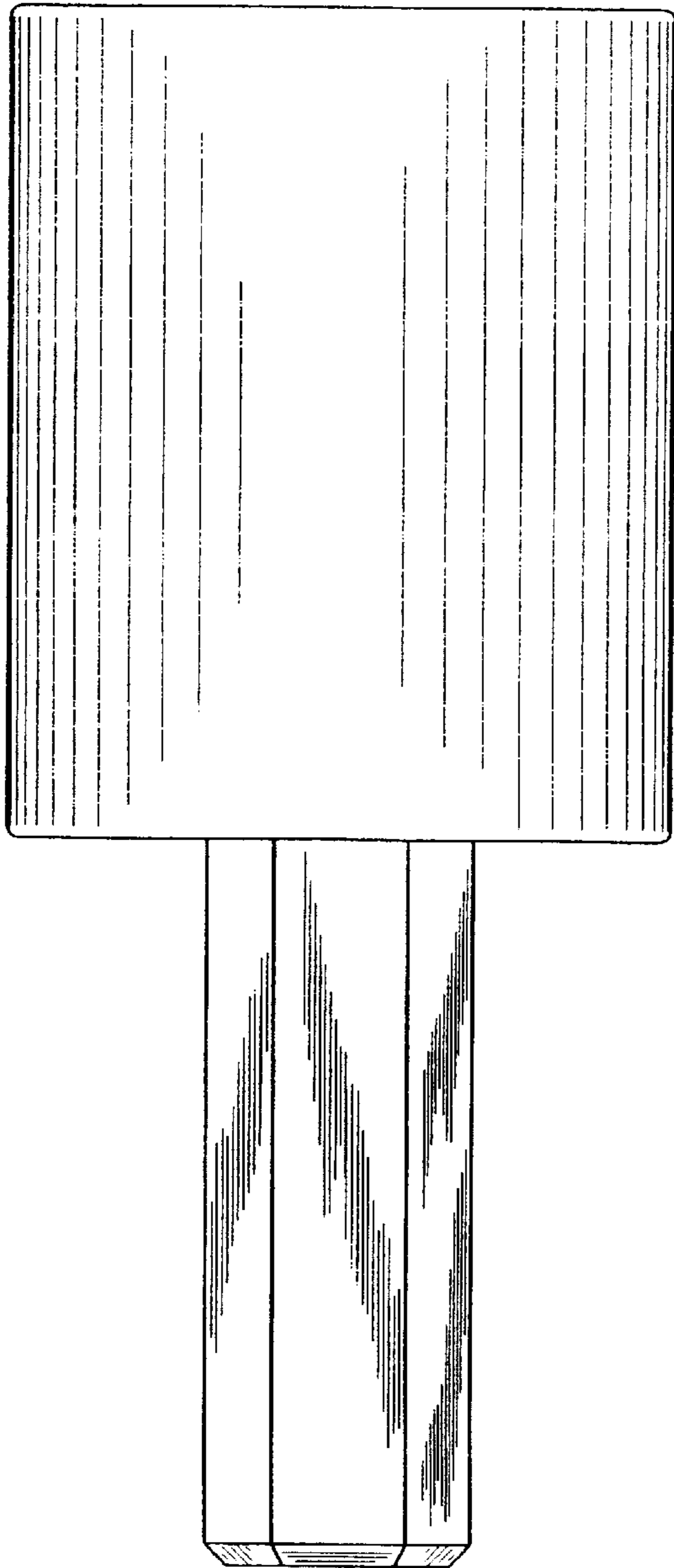

*FIG. 2*

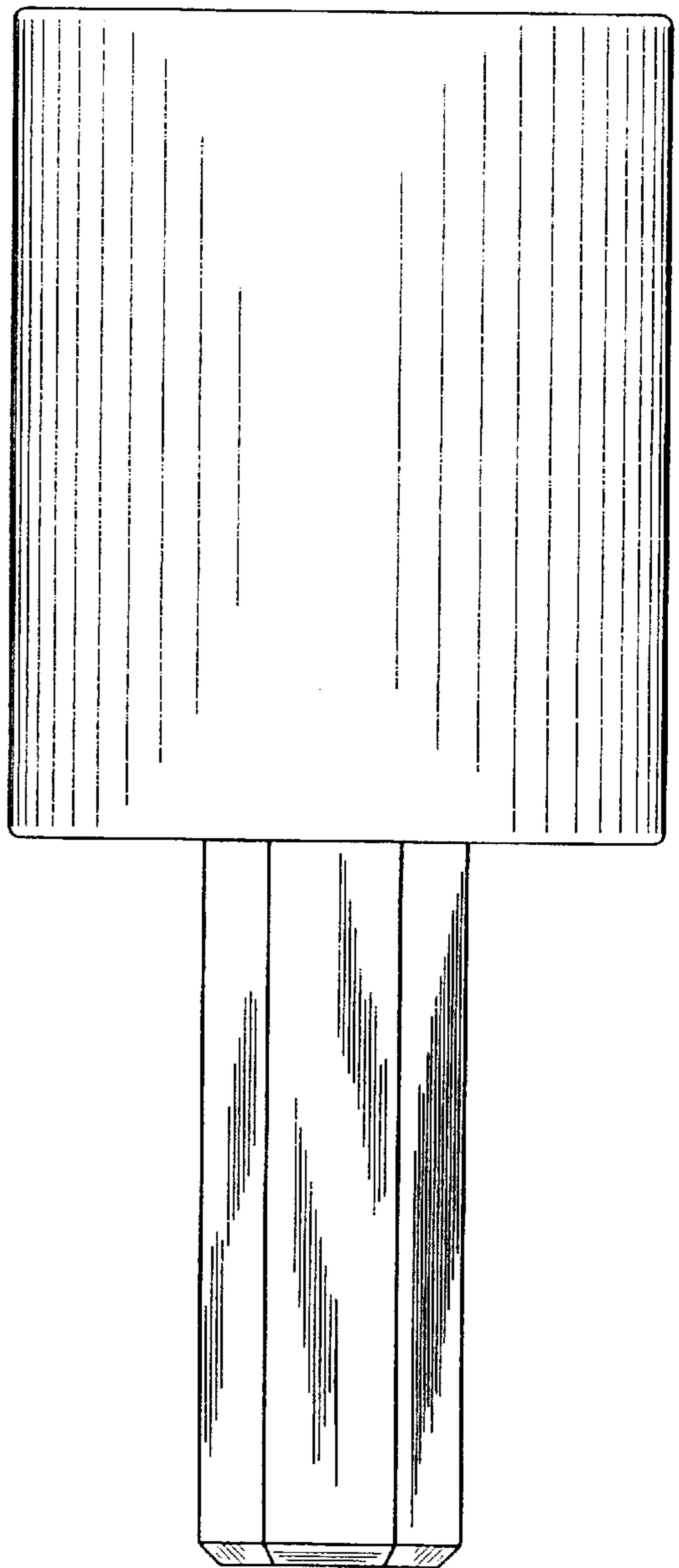

FIG. 3

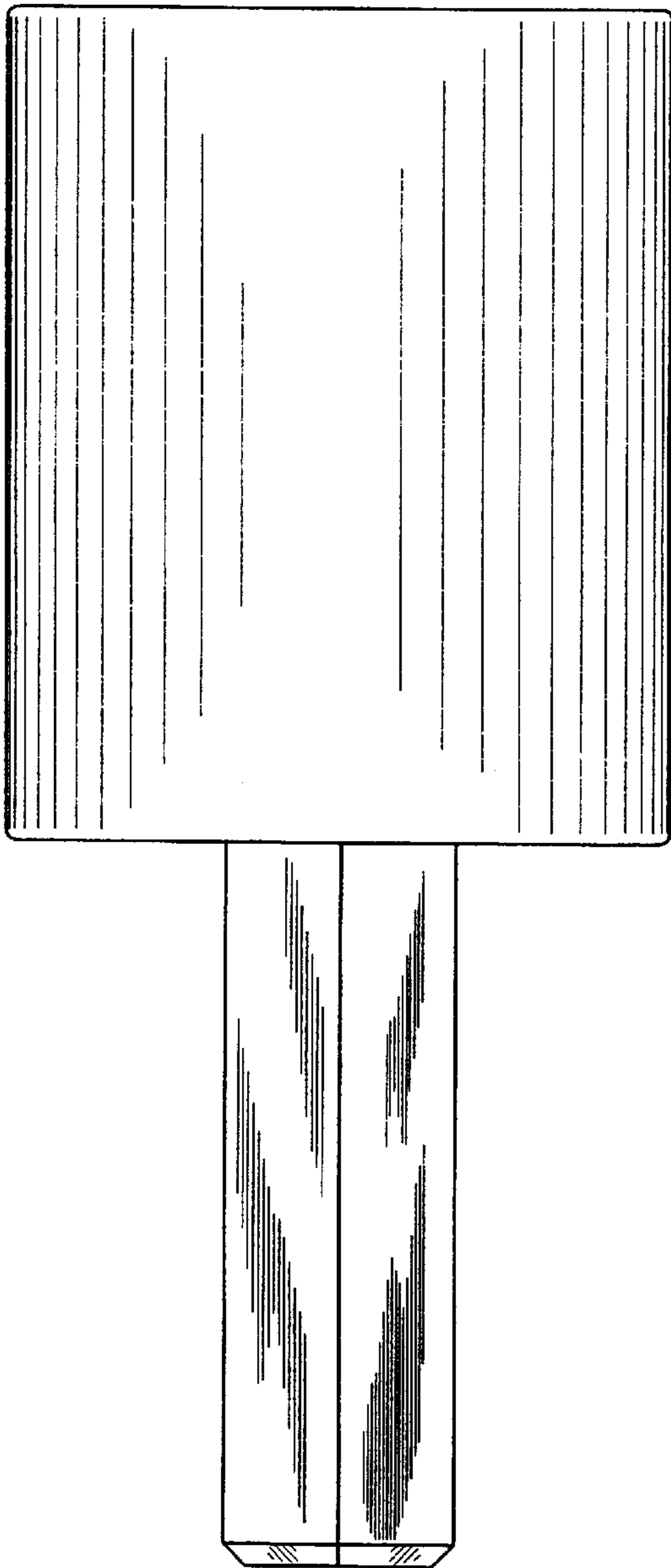

FIG. 4

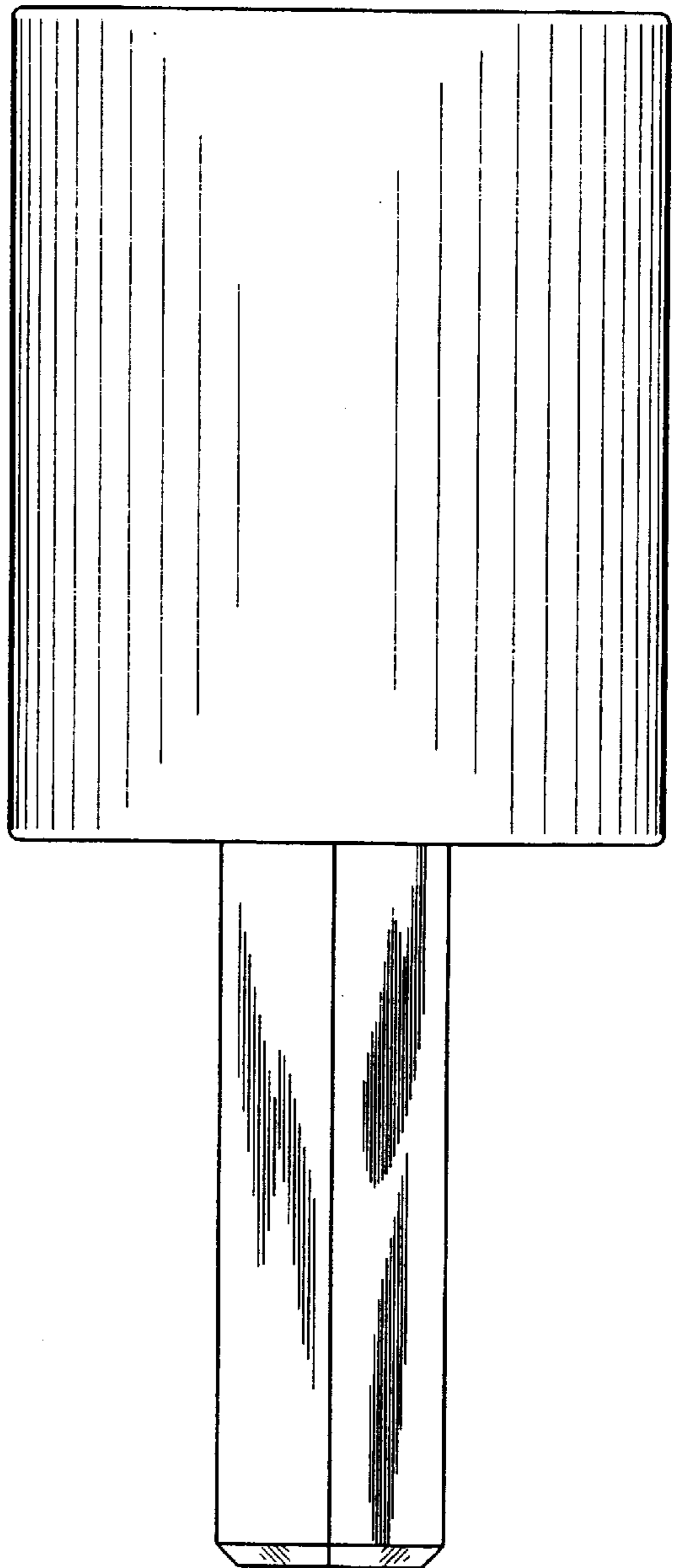

FIG. 5

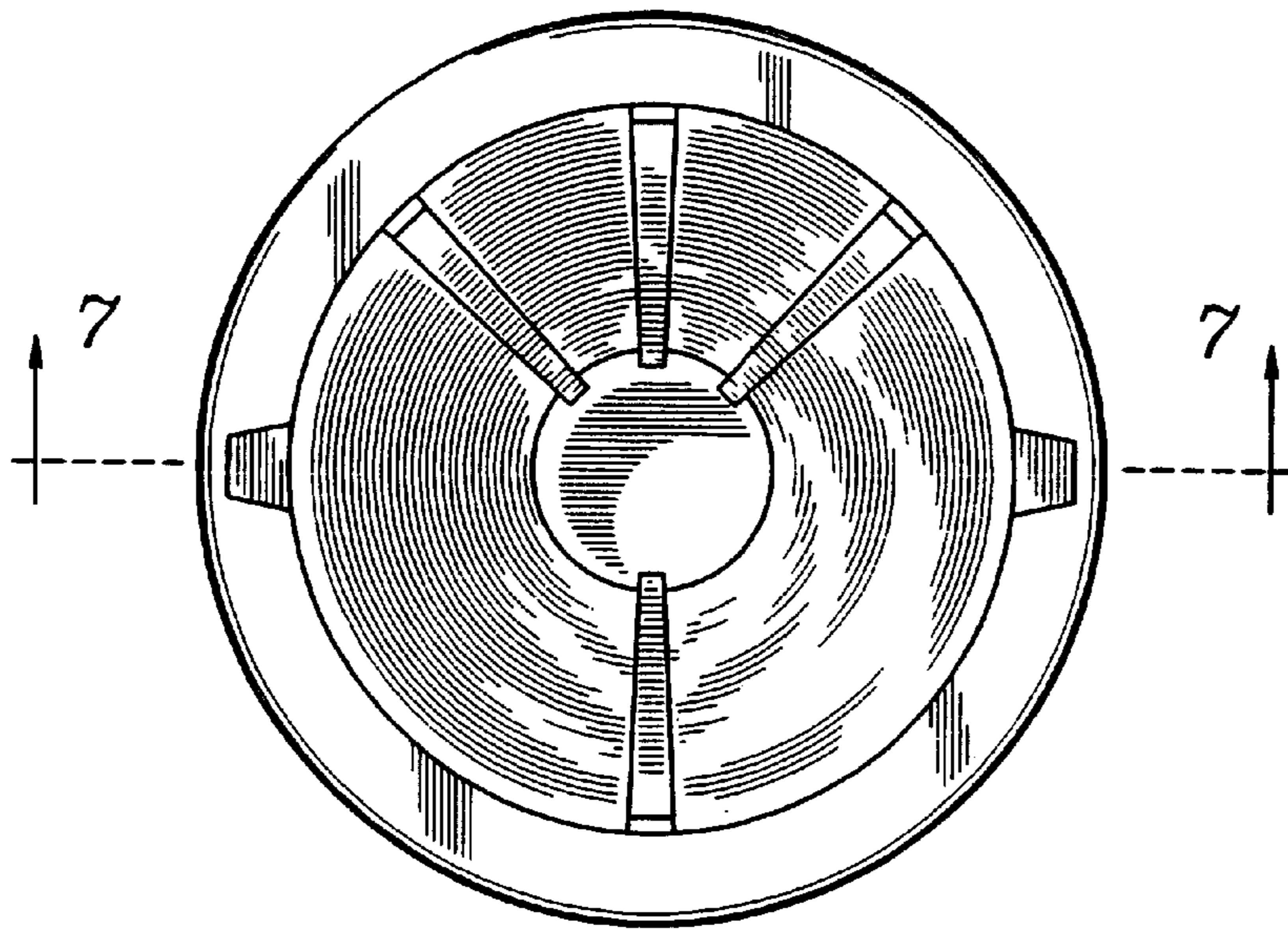
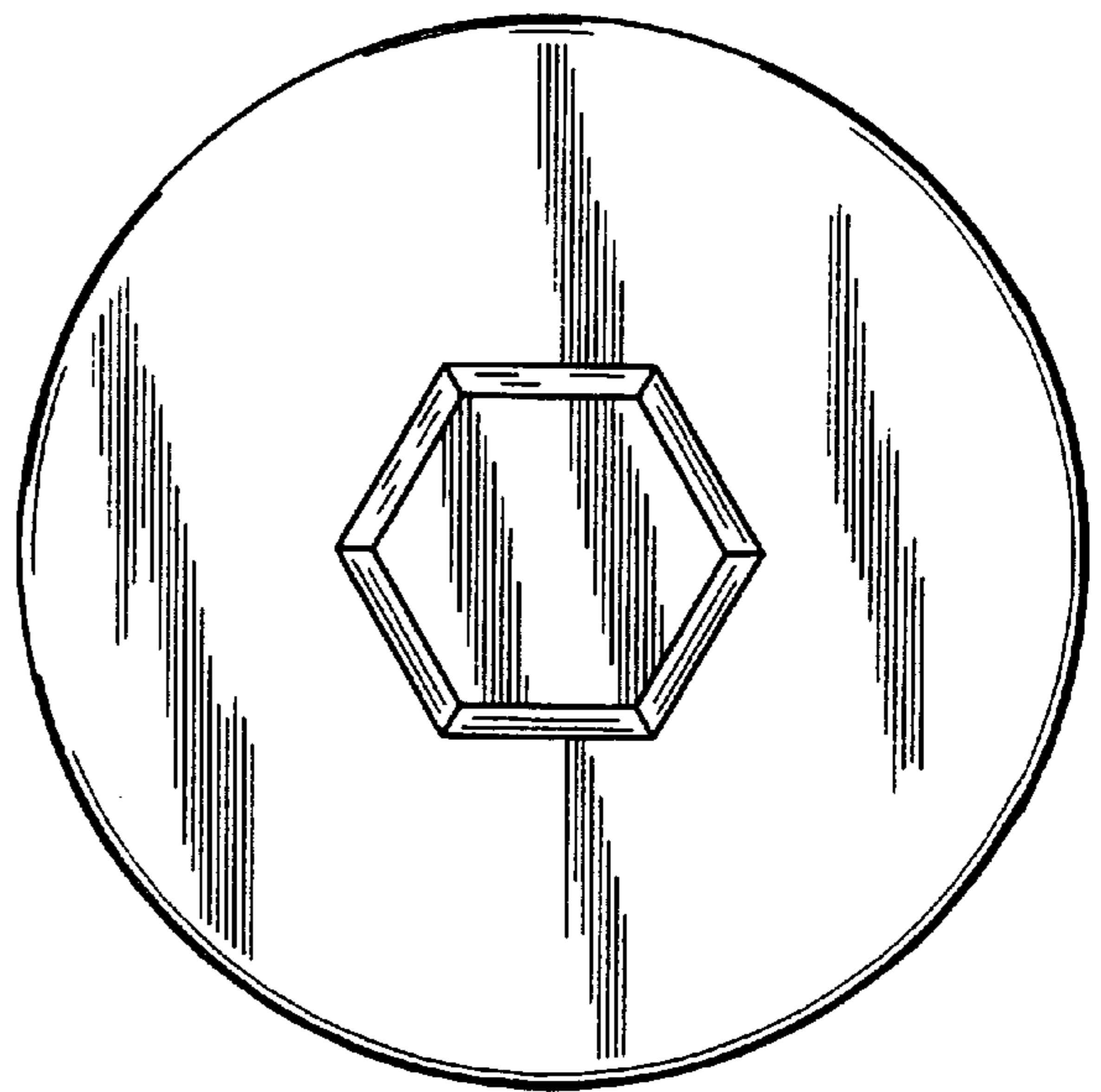

FIG. 6



*FIG. 7*

