



US00D416261S

# United States Patent [19]

Gerba et al.

[11] **Patent Number: Des. 416,261**

[45] **Date of Patent: \*\* Nov. 9, 1999**

[54] **THREE SIDED REMOTE CONTROL**

[75] Inventors: **George Gerba**, Venice; **Margeigh Joy**, San Francisco; **Howard Meiseles**, Stevenson Ranch; **Michael Nichols**, Altadena; **Drew Takahashi**, San Mateo, all of Calif.

[73] Assignee: **Corporate Media Partners**, Los Angeles, Calif.

[\*\*] Term: **14 Years**

[21] Appl. No.: **29/084,867**

[22] Filed: **Mar. 12, 1998**

[51] **LOC (6) Cl.** ..... **14-03**

[52] **U.S. Cl.** ..... **D14/218**

[58] **Field of Search** ..... D14/124, 217, D14/218, 299; D10/104, 106; D13/168; D21/333, 329; 348/734; 455/151.1-151.4, 152.1, 352-355; 200/331

[56] **References Cited**

**U.S. PATENT DOCUMENTS**

- D. 222,966 2/1972 Hawkins et al. .... D13/168
- D. 266,501 10/1982 Stefanik ..... D13/168
- D. 364,872 12/1995 Schwartz ..... D14/218
- D. 375,748 11/1996 Hartman ..... D14/218
- D. 377,797 2/1997 Stropkay et al. .... D14/218

- D. 384,939 10/1997 Schaffner ..... D13/168
- D. 386,185 11/1997 Cho ..... D14/217
- D. 388,792 1/1998 Nykerk ..... D14/218
- D. 406,568 3/1999 Harmuth et al. .... D13/168

**OTHER PUBLICATIONS**

International Business Machines Corporation, "IBM Aptiva Computer Setup Poster," with illustration showing PC Remote, printed, Aug., 1997.

*Primary Examiner*—Louis S. Zarfes

*Assistant Examiner*—Gregory Andoll

*Attorney, Agent, or Firm*—Brown Raysman Millstein Felder & Steiner LLP

[57] **CLAIM**

The ornamental design for a three sided remote control, as shown and described.

**DESCRIPTION**

FIG. 1 is a front and right side perspective view of a three sided remote control showing our new design; FIG. 2 is a front elevational view thereof; FIG. 3 is a back and right side perspective view thereof; FIG. 4 is a back elevational view thereof; FIG. 5 is a right side elevational view thereof; FIG. 6 is a left side elevational view thereof; FIG. 7 is a top elevational view thereof; and, FIG. 8 is a bottom elevational view thereof.

**1 Claim, 6 Drawing Sheets**

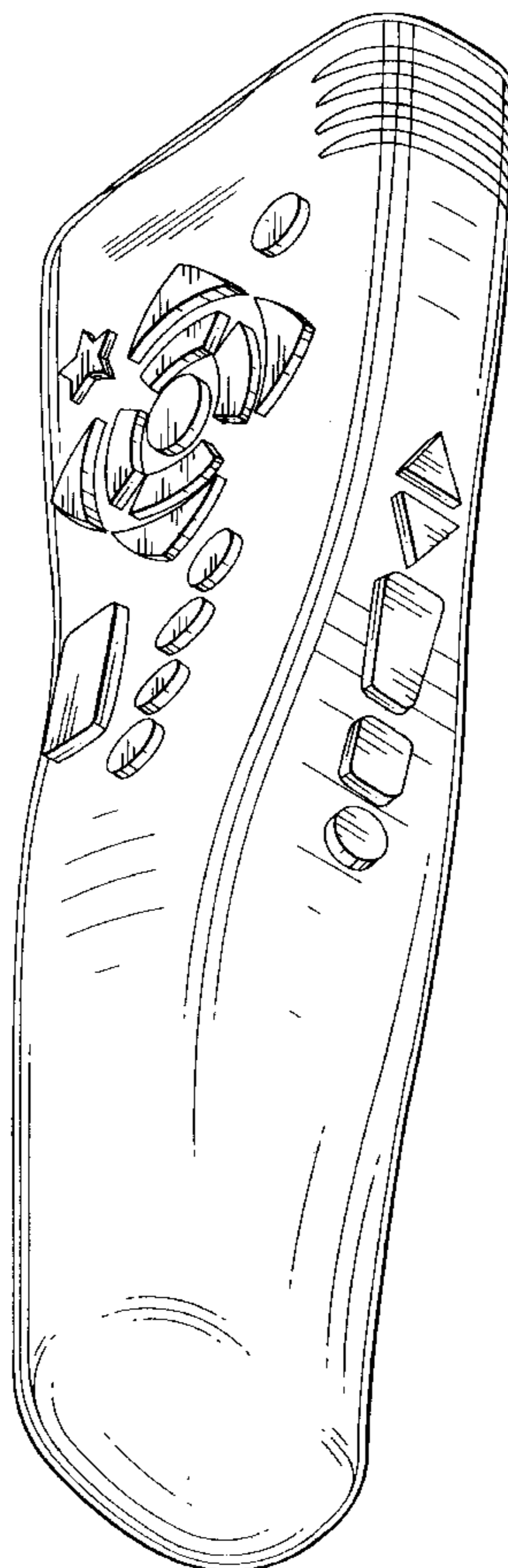

FIG. 1

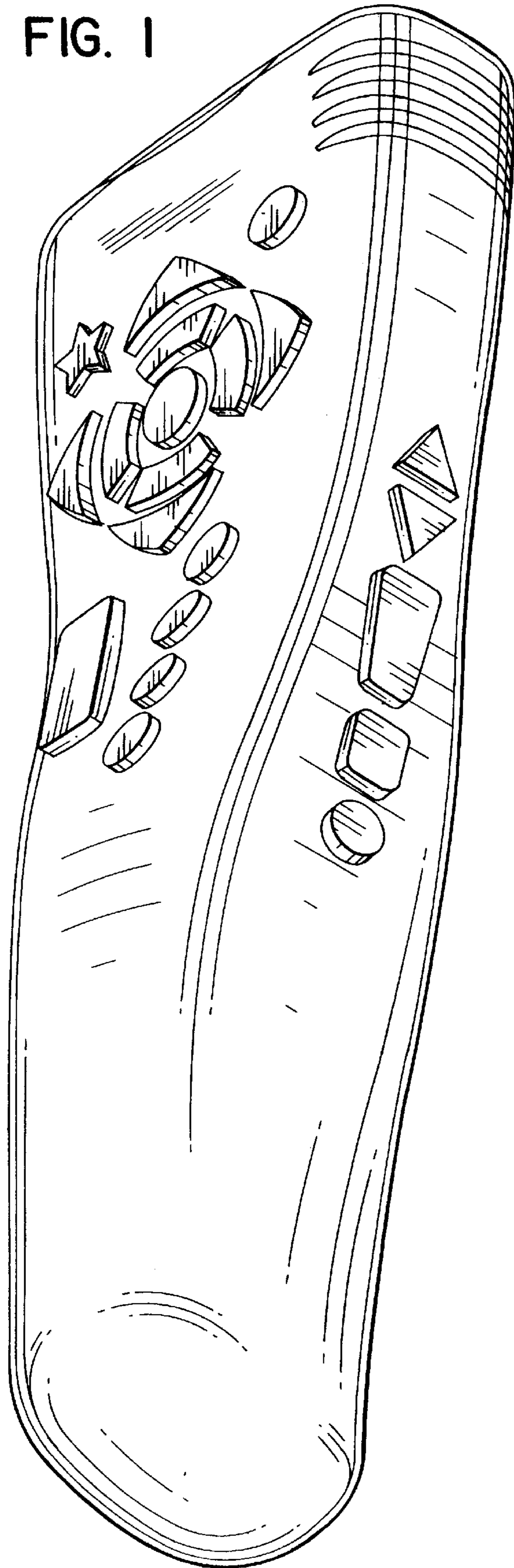
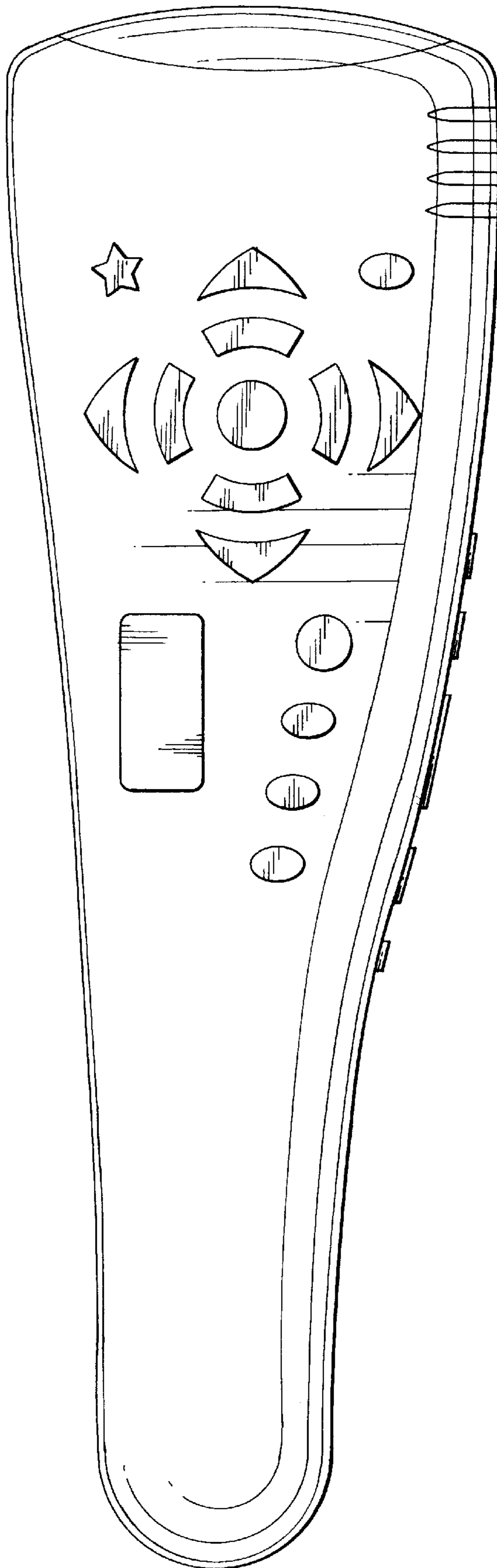

FIG. 2



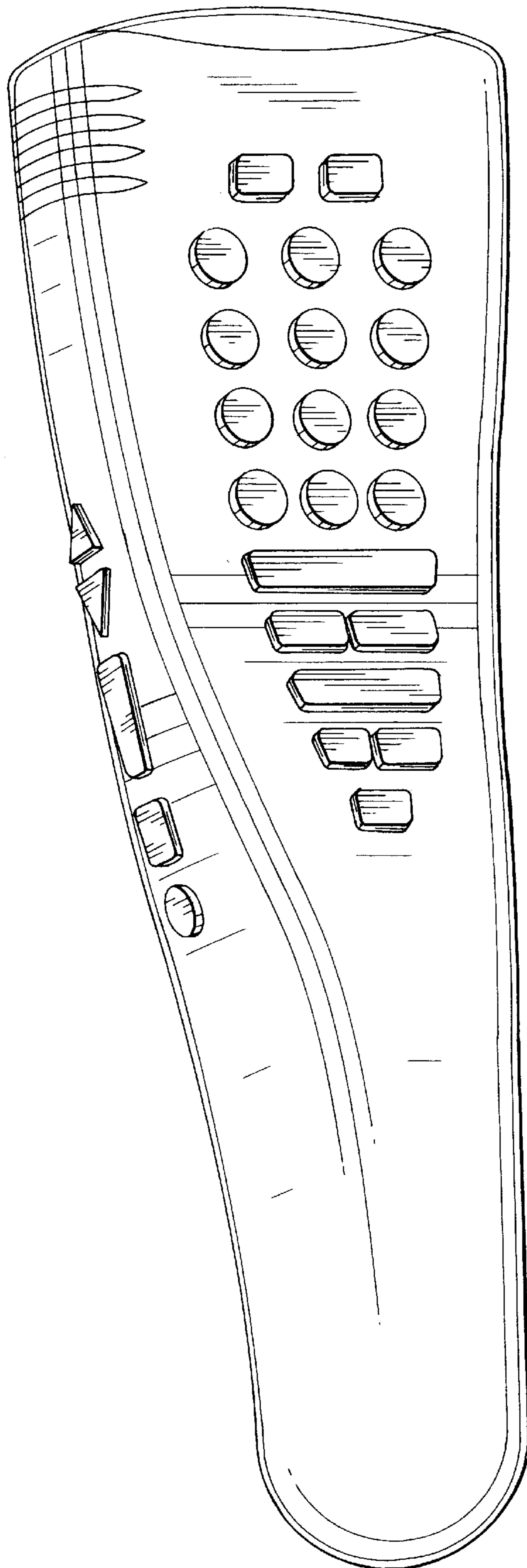
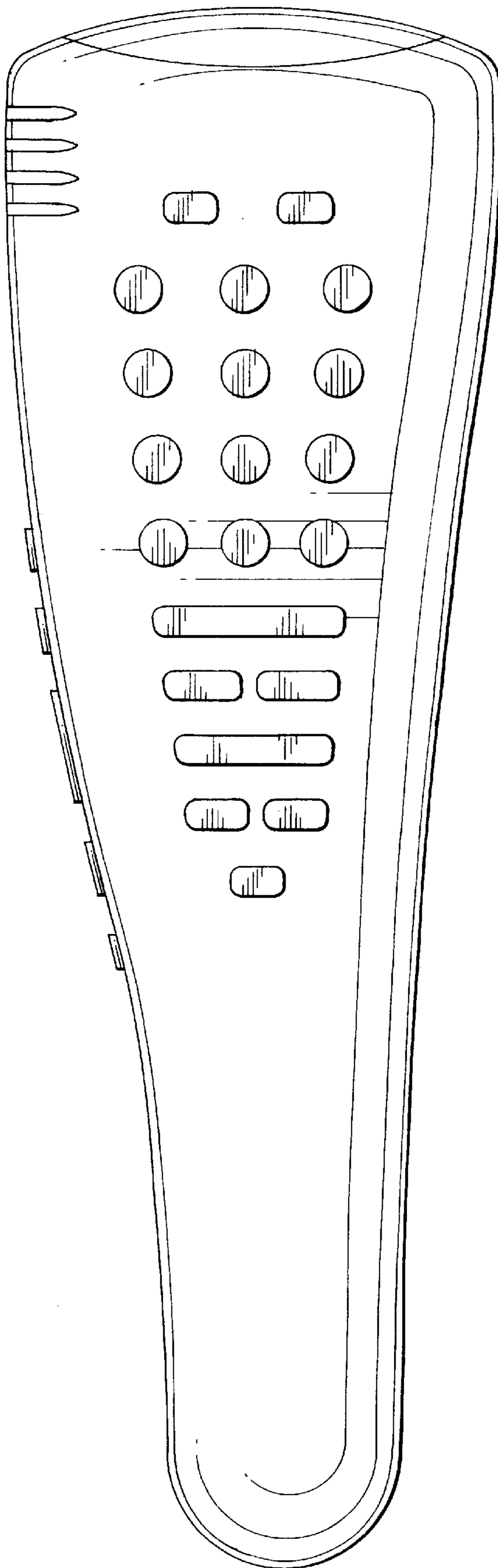

FIG. 3

FIG. 4



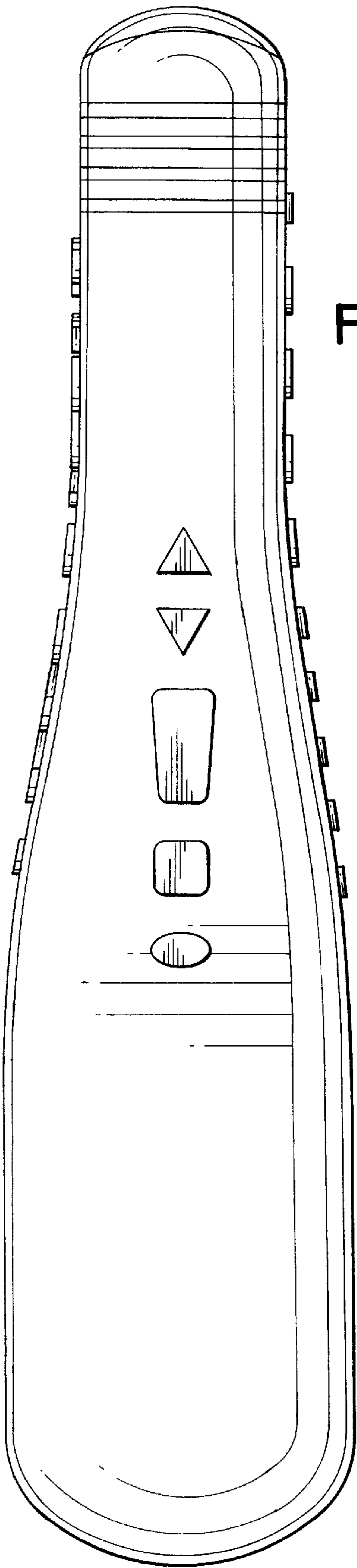

FIG. 5

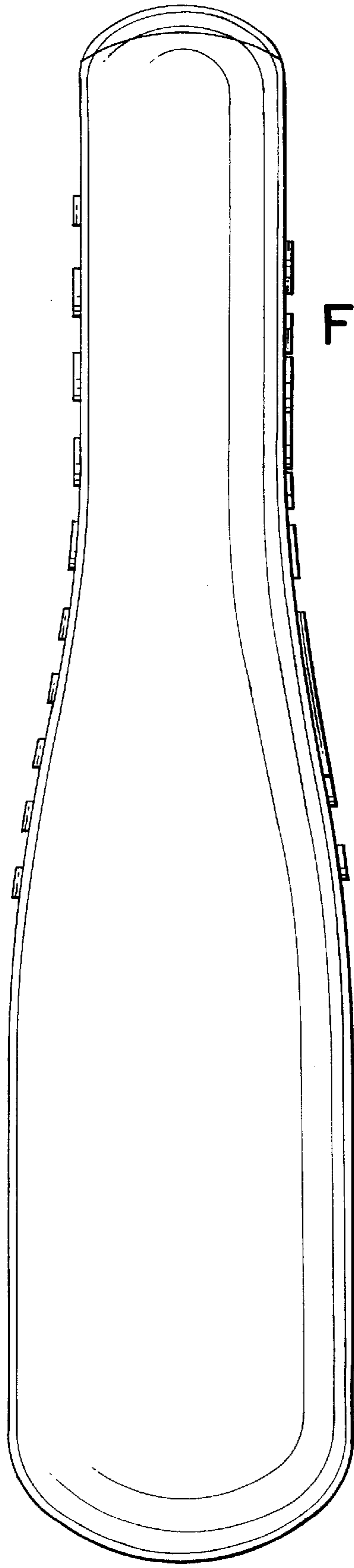

FIG. 6

FIG. 7

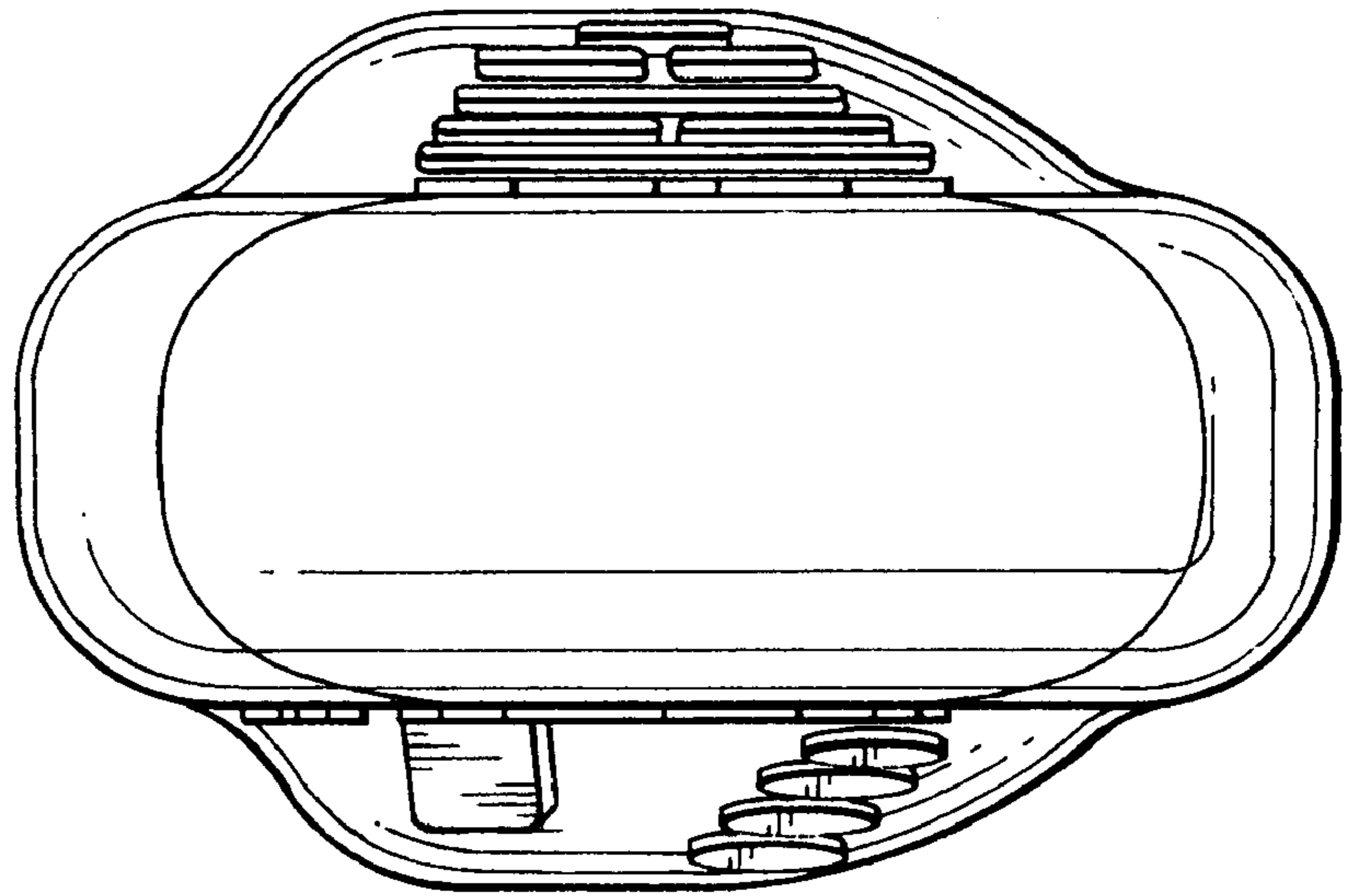

FIG. 8

