



US00D416113S

United States Patent [19]

[11] Patent Number: Des. 416,113

Puri

[45] Date of Patent: ** Nov. 2, 1999

[54] VACUUM CLEANER

[75] Inventor: **Krishan Kumar Puri**, Richmond, Canada

[73] Assignee: **Citywide Machine Wholesale, Inc.**, Richmond

[**] Term: **14 Years**

[21] Appl. No.: **29/086,978**

[22] Filed: **Apr. 23, 1998**

[30] Foreign Application Priority Data

Mar. 12, 1998 [CA] Canada 1998-0605

[51] LOC (6) Cl. **15-05**

[52] U.S. Cl. **D32/21**

[58] Field of Search D32/21, 23, 24;
15/320-321, 327.1, 327.2, 327.6, 327.7,
347

[56] References Cited

U.S. PATENT DOCUMENTS

D. 279,321 6/1985 Schoettler D32/24

D. 289,097	3/1987	Takahashi et al.	D32/24
D. 312,902	12/1990	Essex et al.	D32/24
D. 318,544	7/1991	Schoettler	D32/24
D. 352,146	11/1994	Wulff	D32/24
D. 355,283	2/1995	Thomas et al.	D32/24
D. 386,842	11/1997	Hoshino et al.	D32/21
D. 399,616	10/1998	Bobrosky et al.	D32/21

Primary Examiner—Ruth McInroy
Attorney, Agent, or Firm—Kolisch Hartwell Dickinson
McCormack & Heuser

[57] CLAIM

The ornamental design for a vacuum cleaner, as shown and described.

DESCRIPTION

FIG. 1 is a perspective view of the vacuum cleaner according to the present design;
FIG. 2 is a top plan view of the vacuum cleaner;
FIG. 3 is a left side view;
FIG. 4 is a bottom plan view;
FIG. 5 is a right side view;
FIG. 6 is a rear elevation view; and,
FIG. 7 is a front elevation end view.

1 Claim, 6 Drawing Sheets

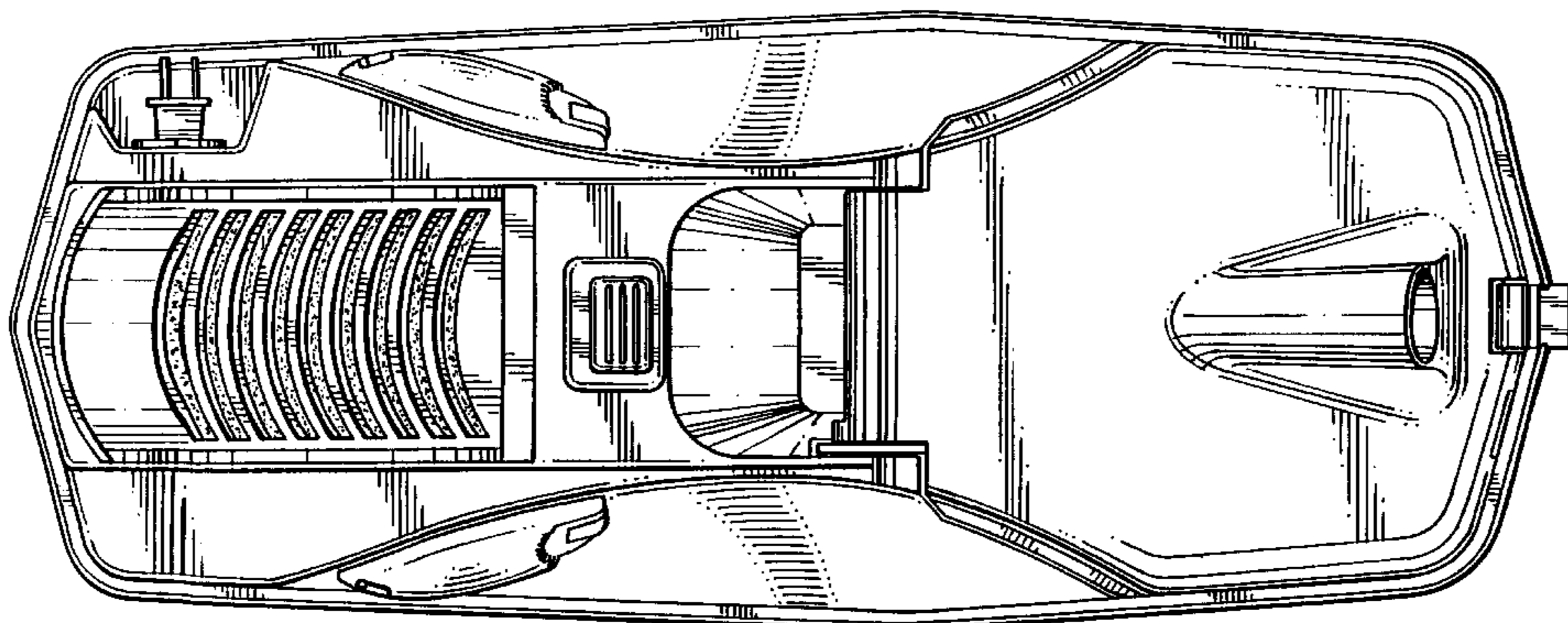
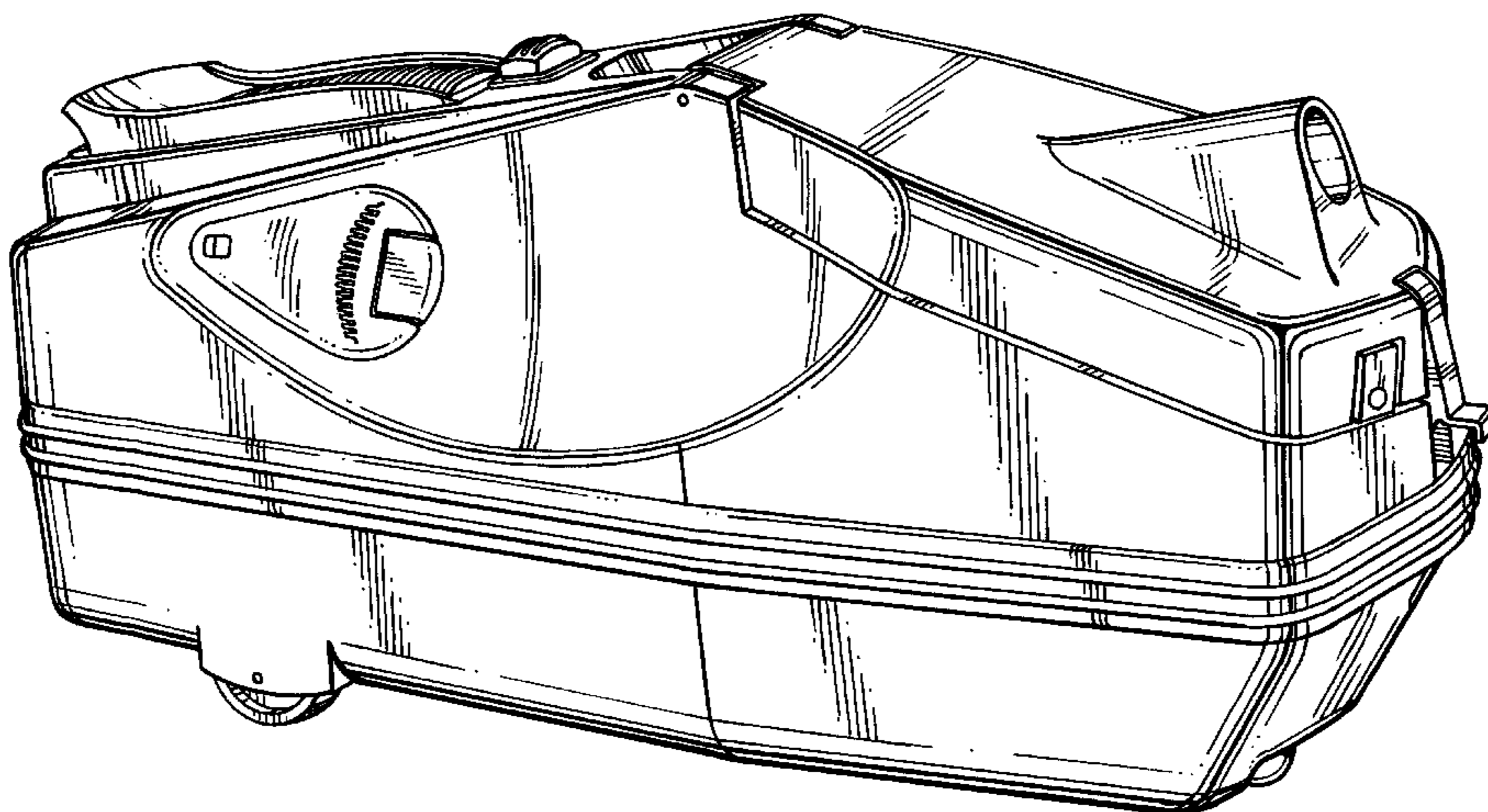

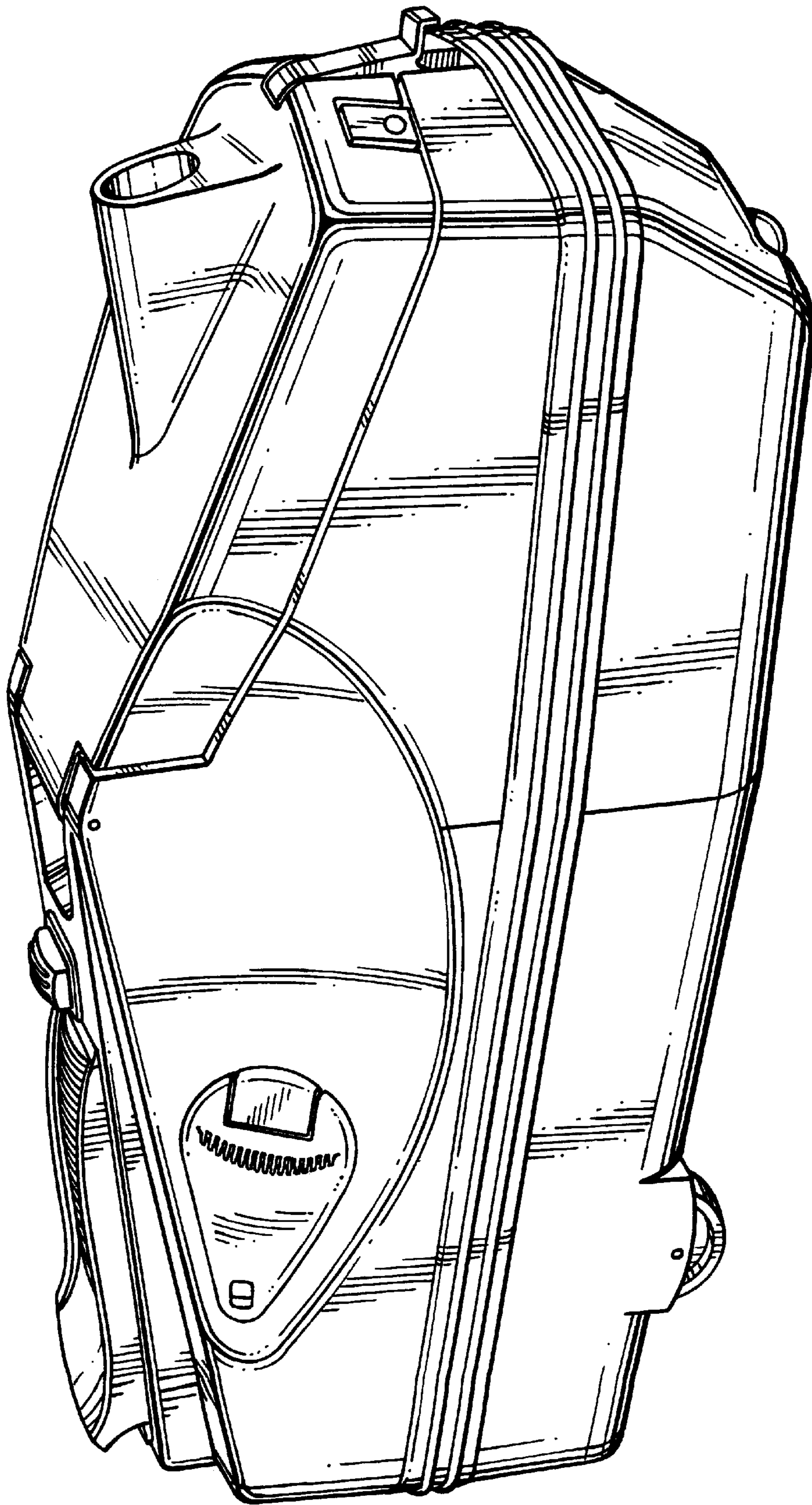

FIG. 1

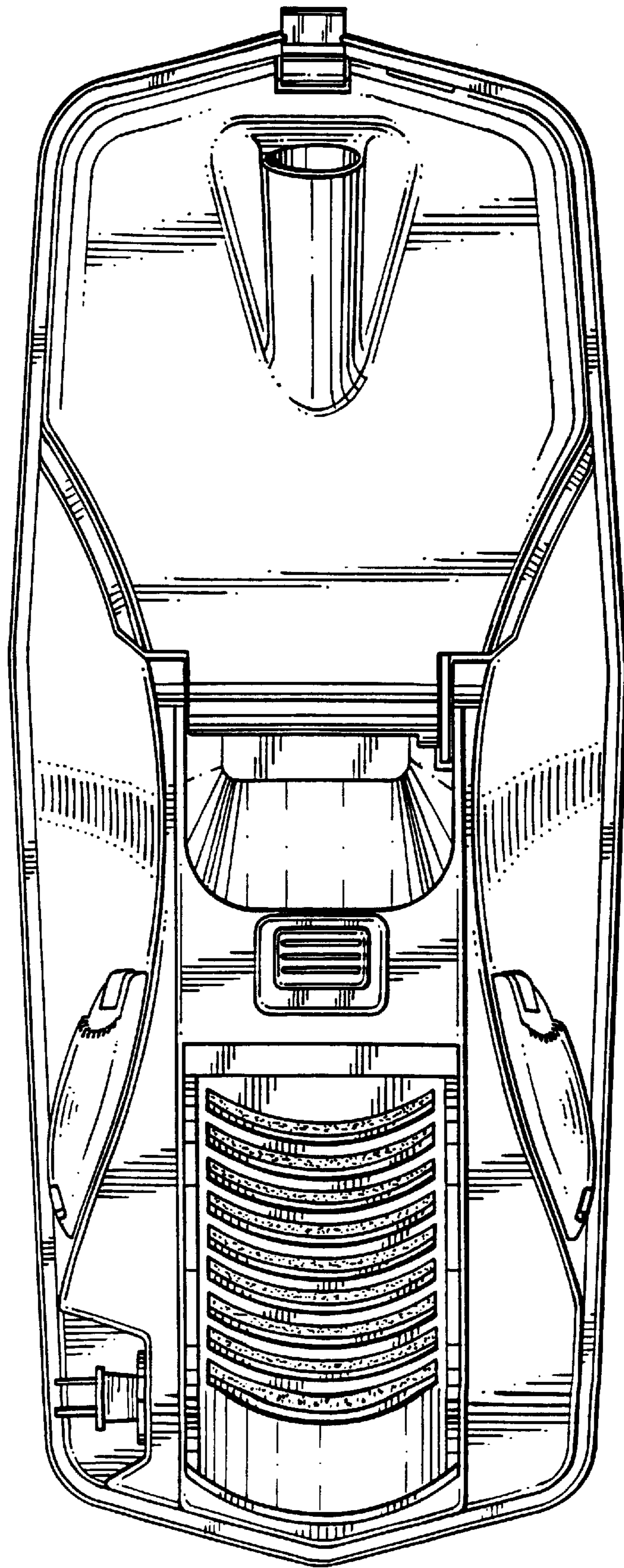

FIG. 2

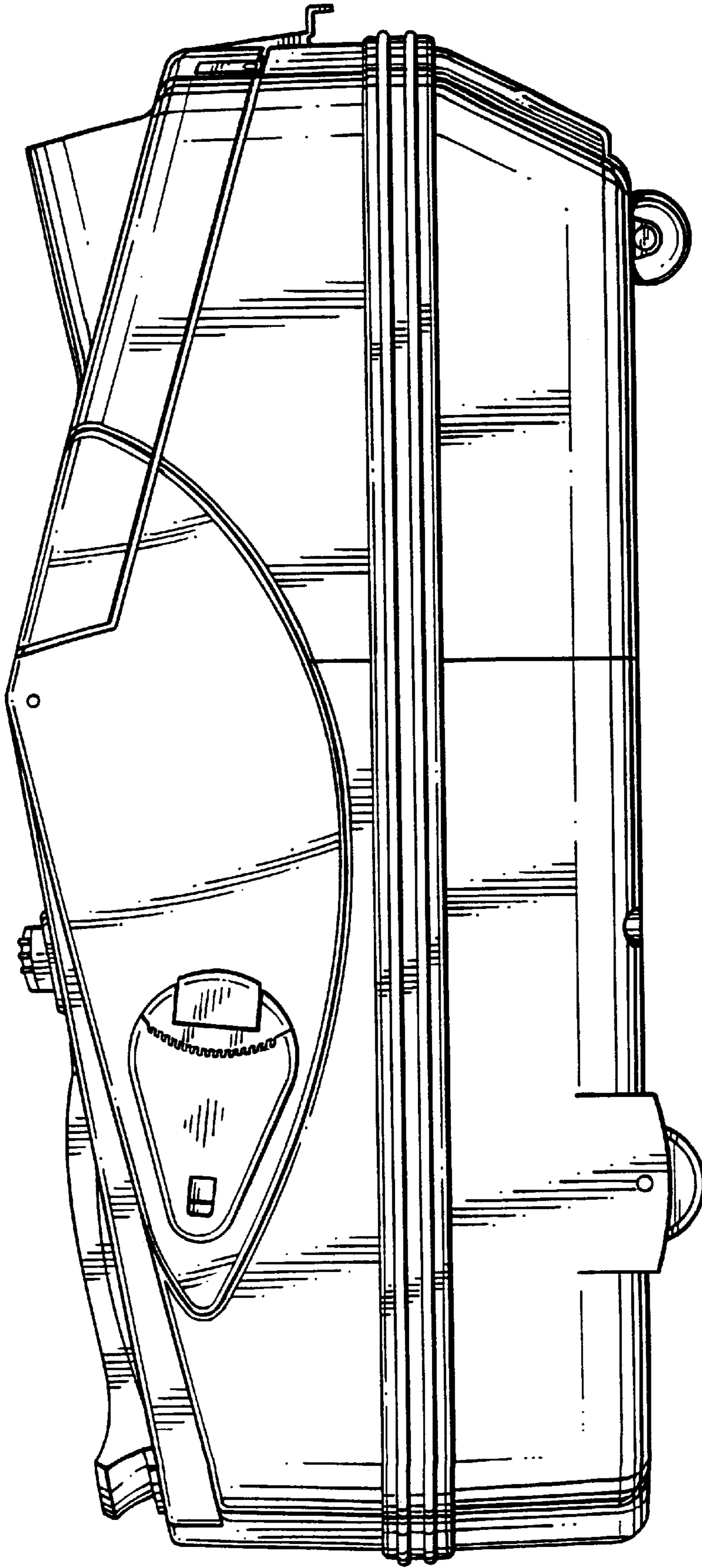

FIG. 3

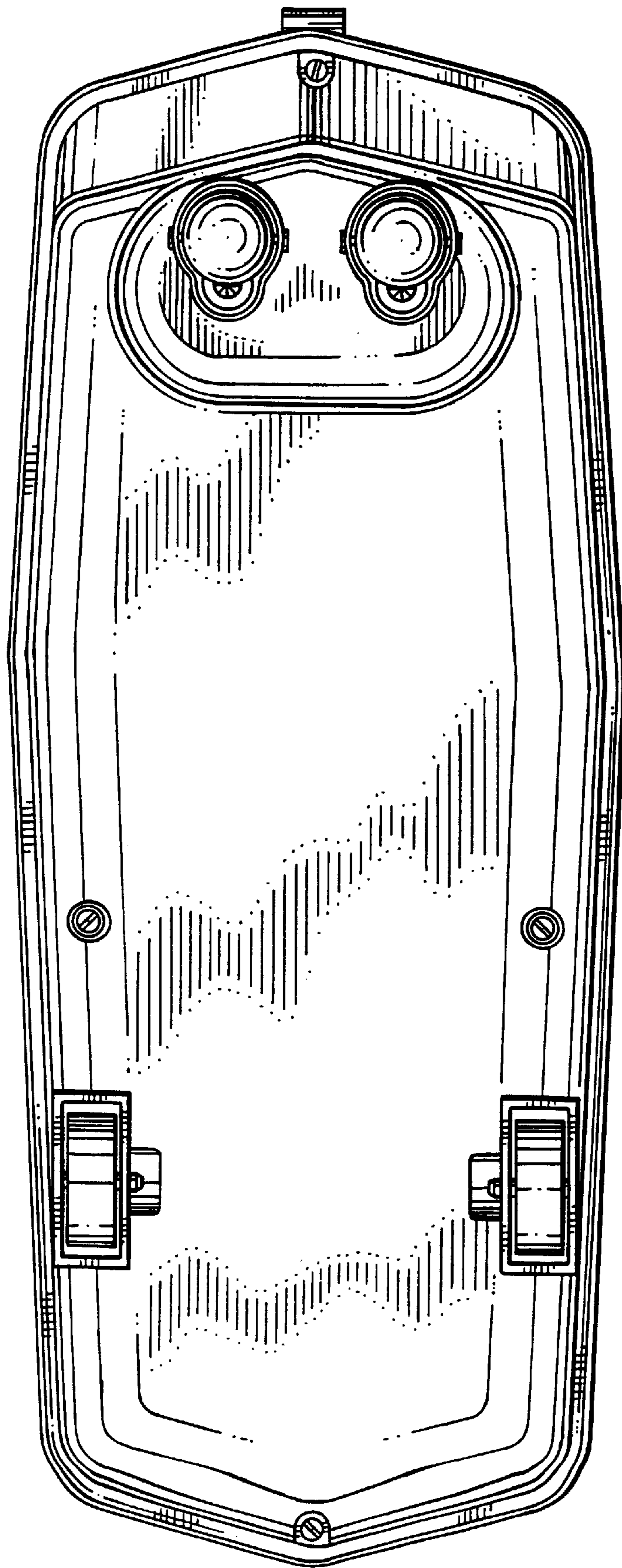

FIG. 4

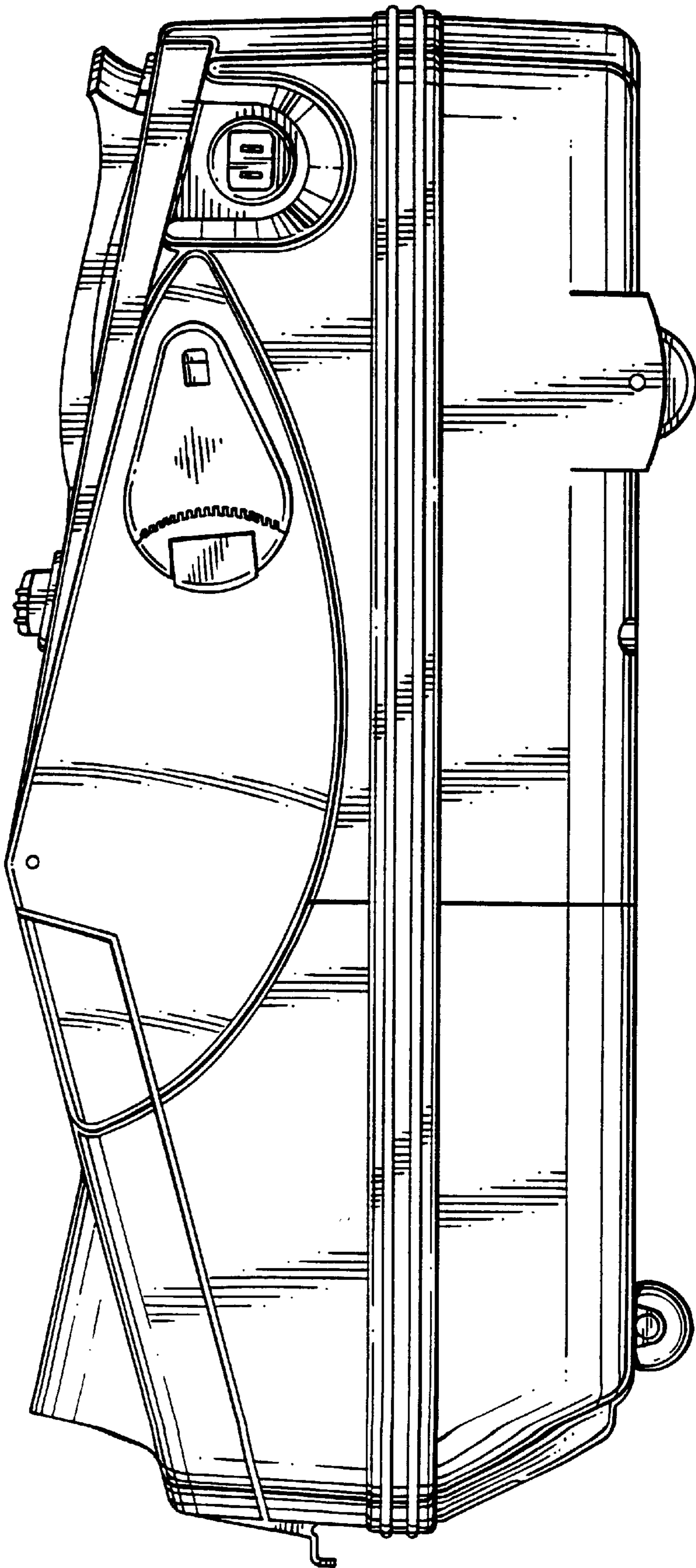

FIG. 5

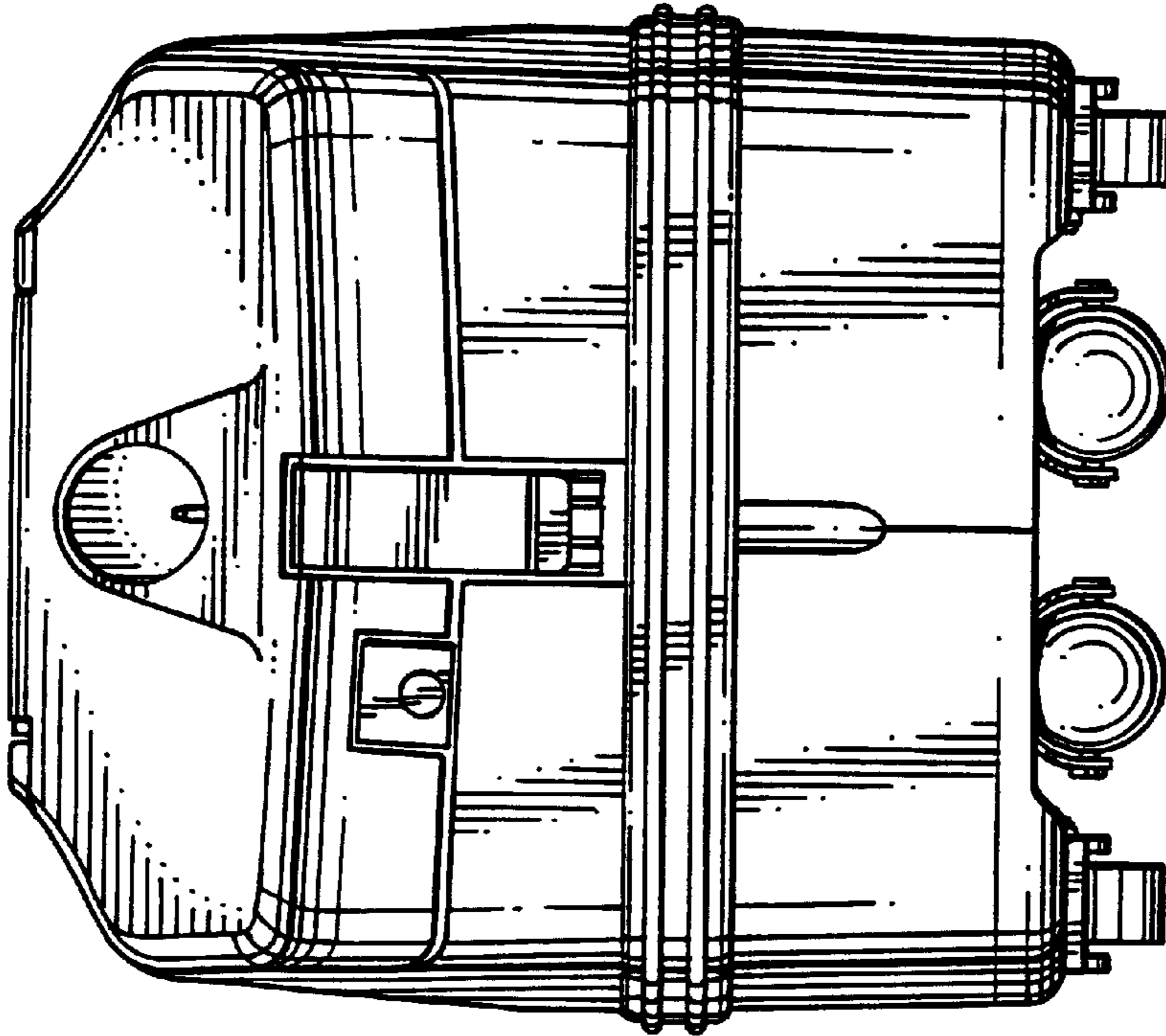

FIG. 7

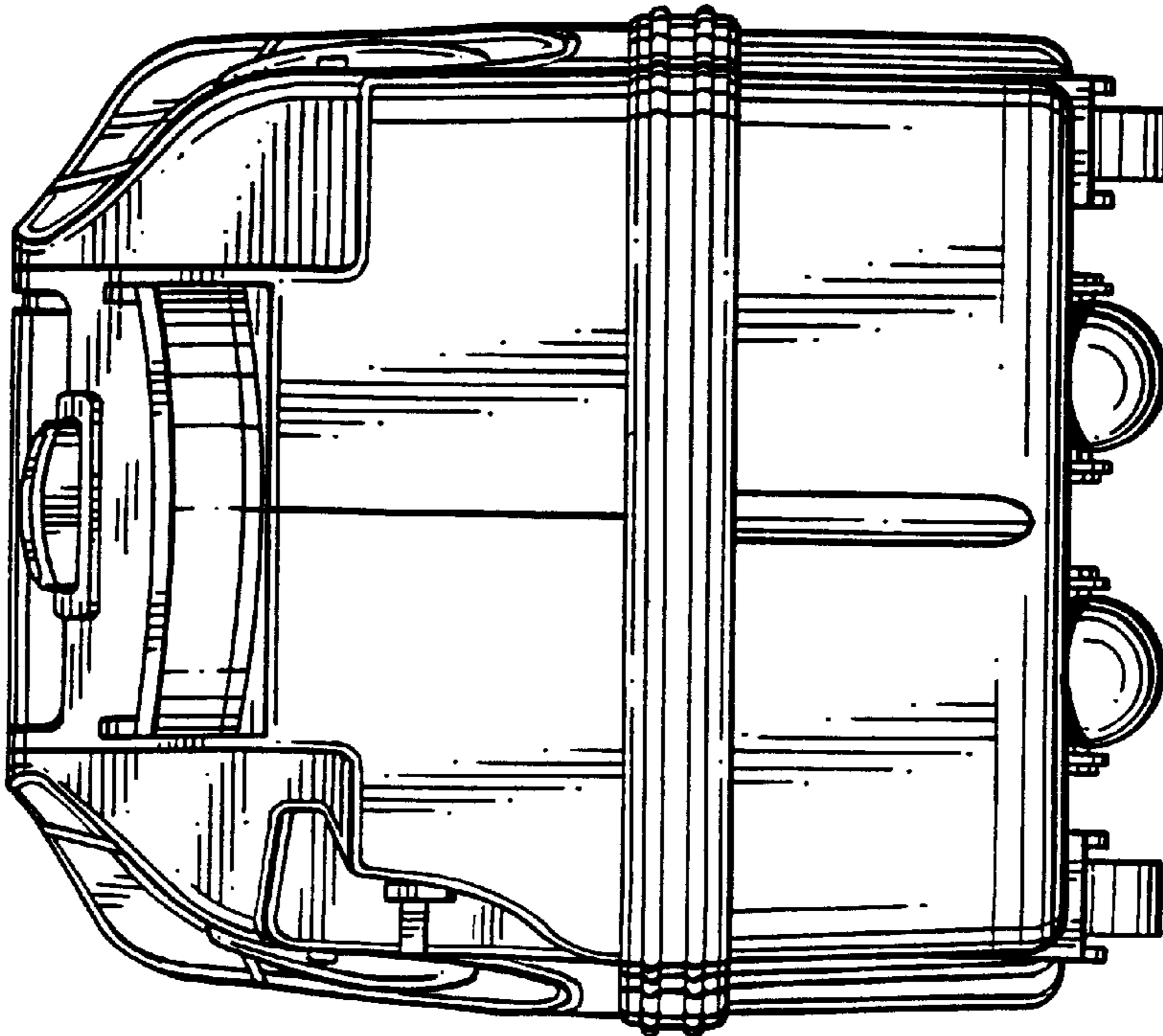

FIG. 6