



US00D416014S

**United States Patent** [19]  
**Nara**

[11] **Patent Number: Des. 416,014**

[45] **Date of Patent: \*\* Nov. 2, 1999**

[54] **COMBINED TELEVISION AND DISC PLAYER**

[75] Inventor: **Yoichi Nara**, Tokyo, Japan

[73] Assignee: **Sony Corporation**, Tokyo, Japan

[\*\*] Term: **14 Years**

[21] Appl. No.: **29/079,490**

[22] Filed: **Nov. 17, 1997**

[30] **Foreign Application Priority Data**

May 21, 1997 [JP] Japan ..... 9-55011

[51] **LOC (6) Cl.** ..... **14-03**

[52] **U.S. Cl.** ..... **D14/129**

[58] **Field of Search** ..... D14/113, 126-134;  
312/7.2; 348/552, 836, 838

[56] **References Cited**

**U.S. PATENT DOCUMENTS**

- D. 350,346 9/1994 Takemasa et al. .... D14/126
- D. 351,835 10/1994 Kawamoto et al. .... D14/129
- D. 356,078 3/1995 Usui et al. .... D14/126
- D. 356,081 3/1995 Naito et al. .... D14/129
- D. 388,077 12/1997 Starck ..... D14/126

*Primary Examiner*—Ted Shooman  
*Assistant Examiner*—Richelle Shelton  
*Attorney, Agent, or Firm*—Foley & Lardner

[57] **CLAIM**

The ornamental design for a combined television and disc Player, as shown and described.

**DESCRIPTION**

FIG. 1 is a perspective view of a first embodiment of a combined television and disc player showing my new design;

FIG. 2 is a top plan view thereof;

FIG. 3 is a left side elevational view thereof;

FIG. 4 is a front elevational view thereof;

FIG. 5 is a bottom plan view thereof;

FIG. 6 is a right side elevational view thereof;

FIG. 7 is a rear elevational view thereof;

FIG. 8 is a perspective view of a second embodiment of a combined television and disc player showing my new design;

FIG. 9 is a top plan view thereof;

FIG. 10 is a left side elevational view thereof;

FIG. 11 is a front elevational view thereof;

FIG. 12 is a bottom plan view thereof;

FIG. 13 is a right side elevational view thereof; and,

FIG. 14 is a rear elevational view thereof.

**1 Claim, 6 Drawing Sheets**

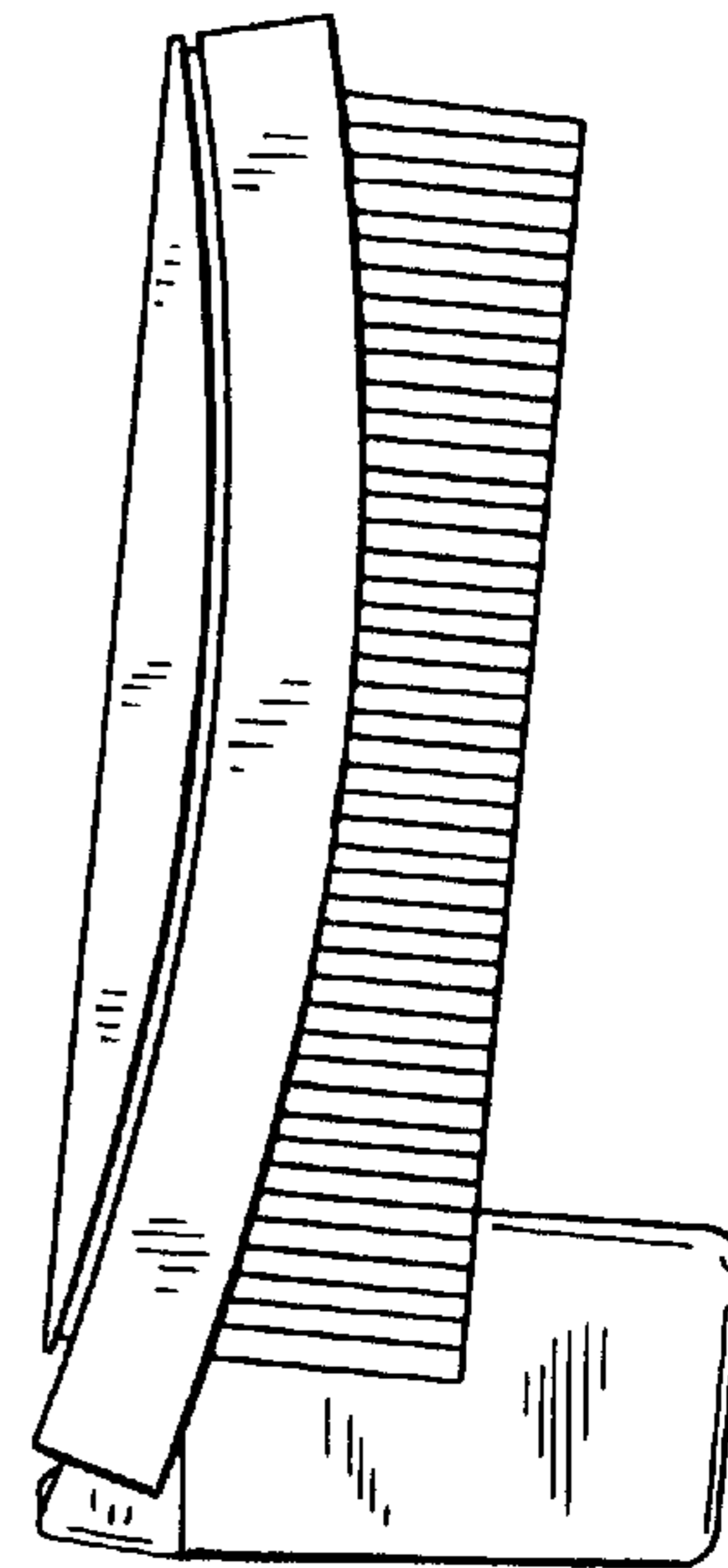
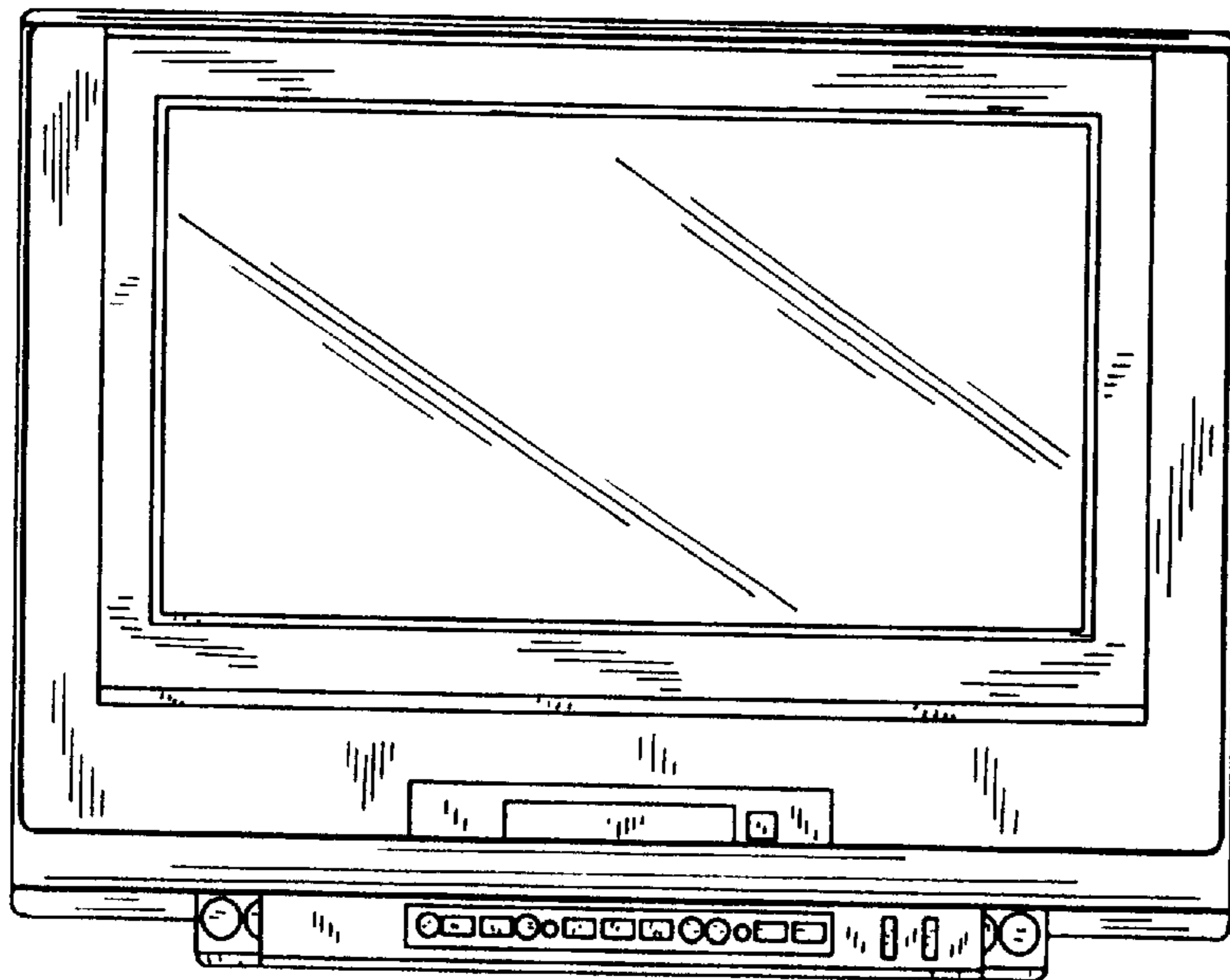

FIG. 1

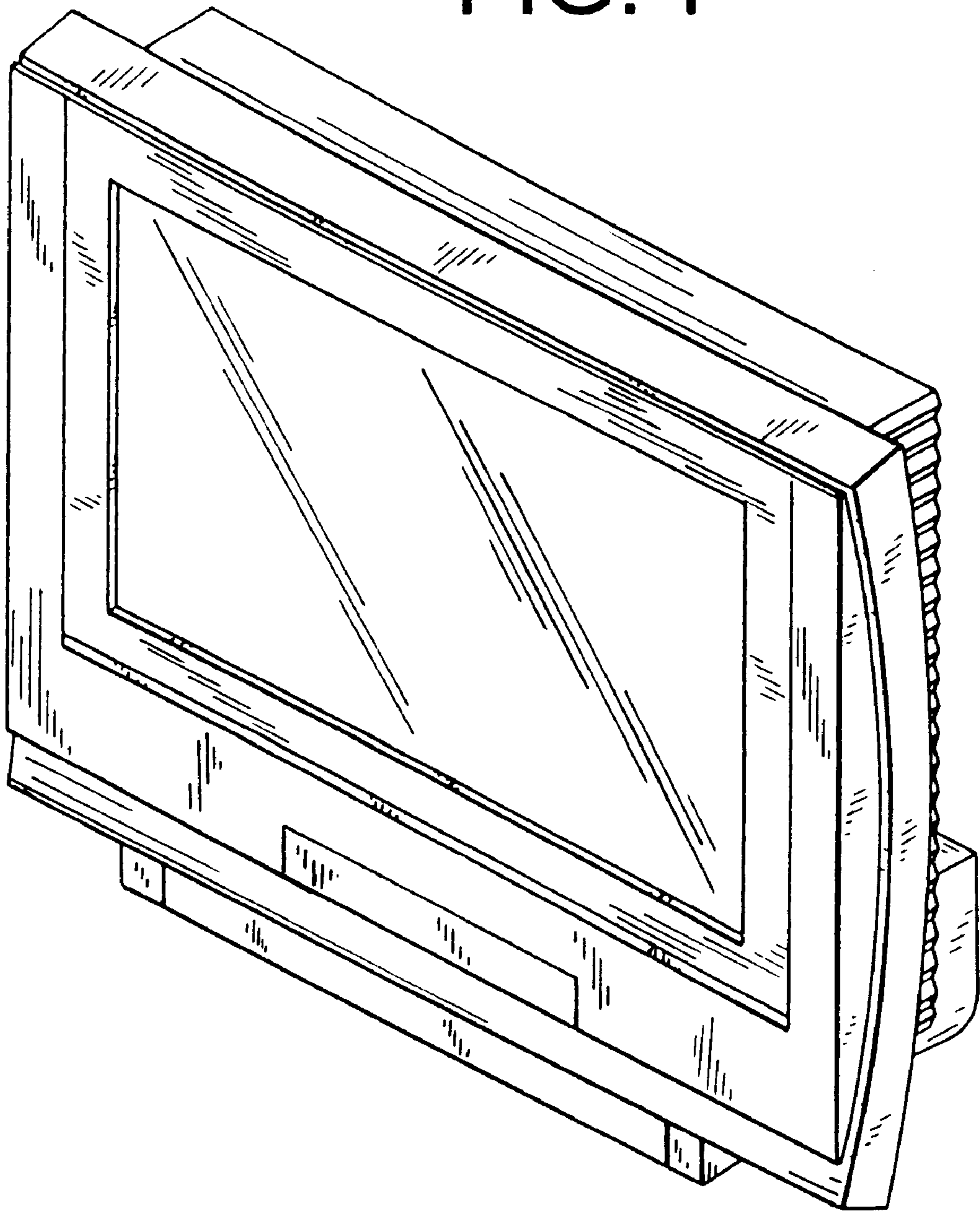

FIG. 2

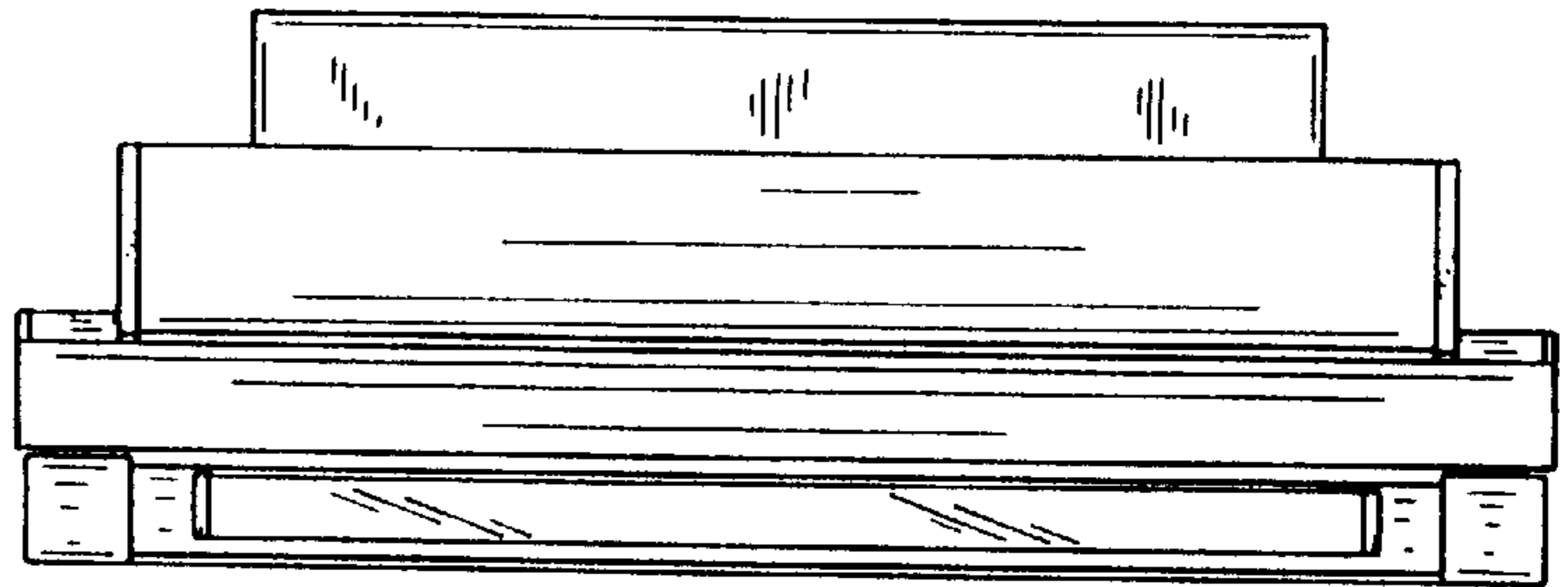

FIG. 3

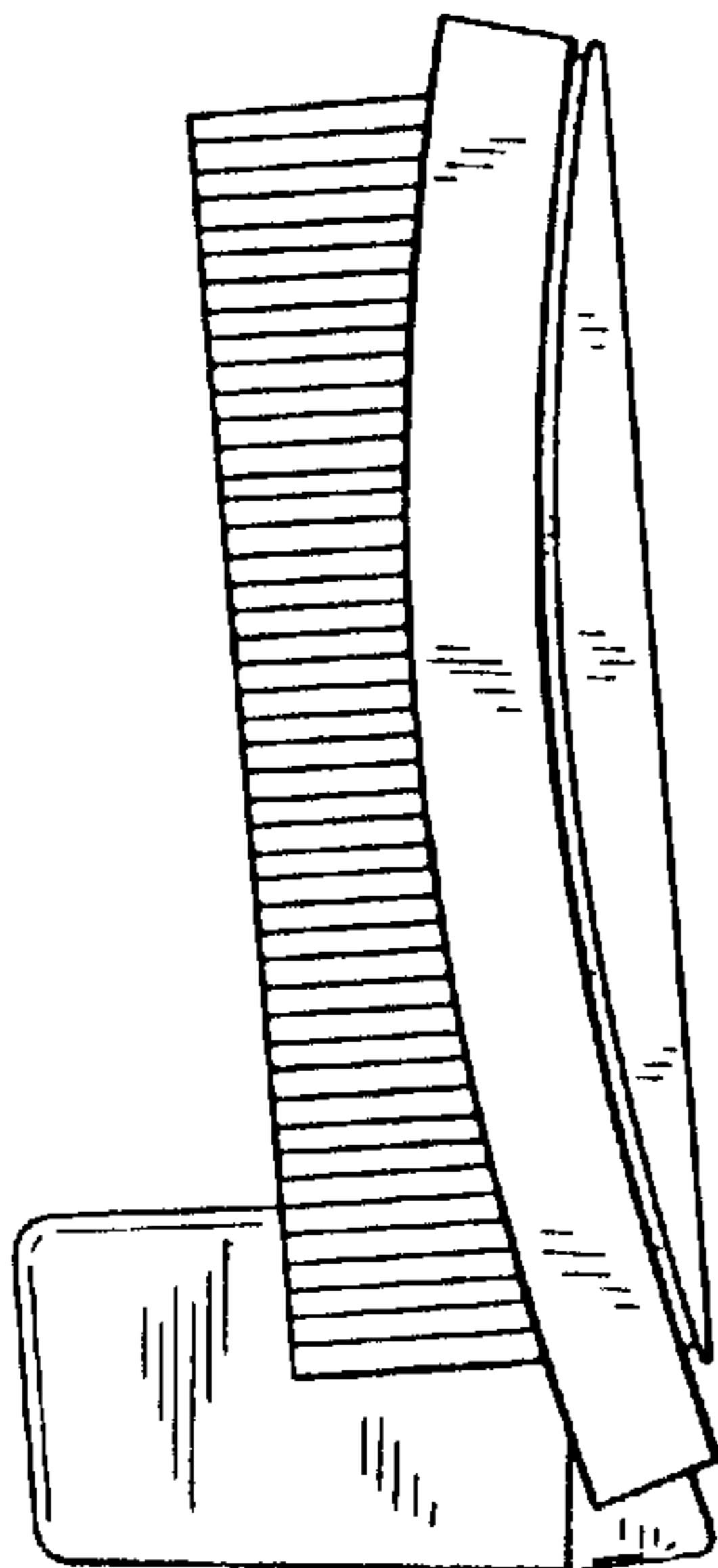

FIG. 4

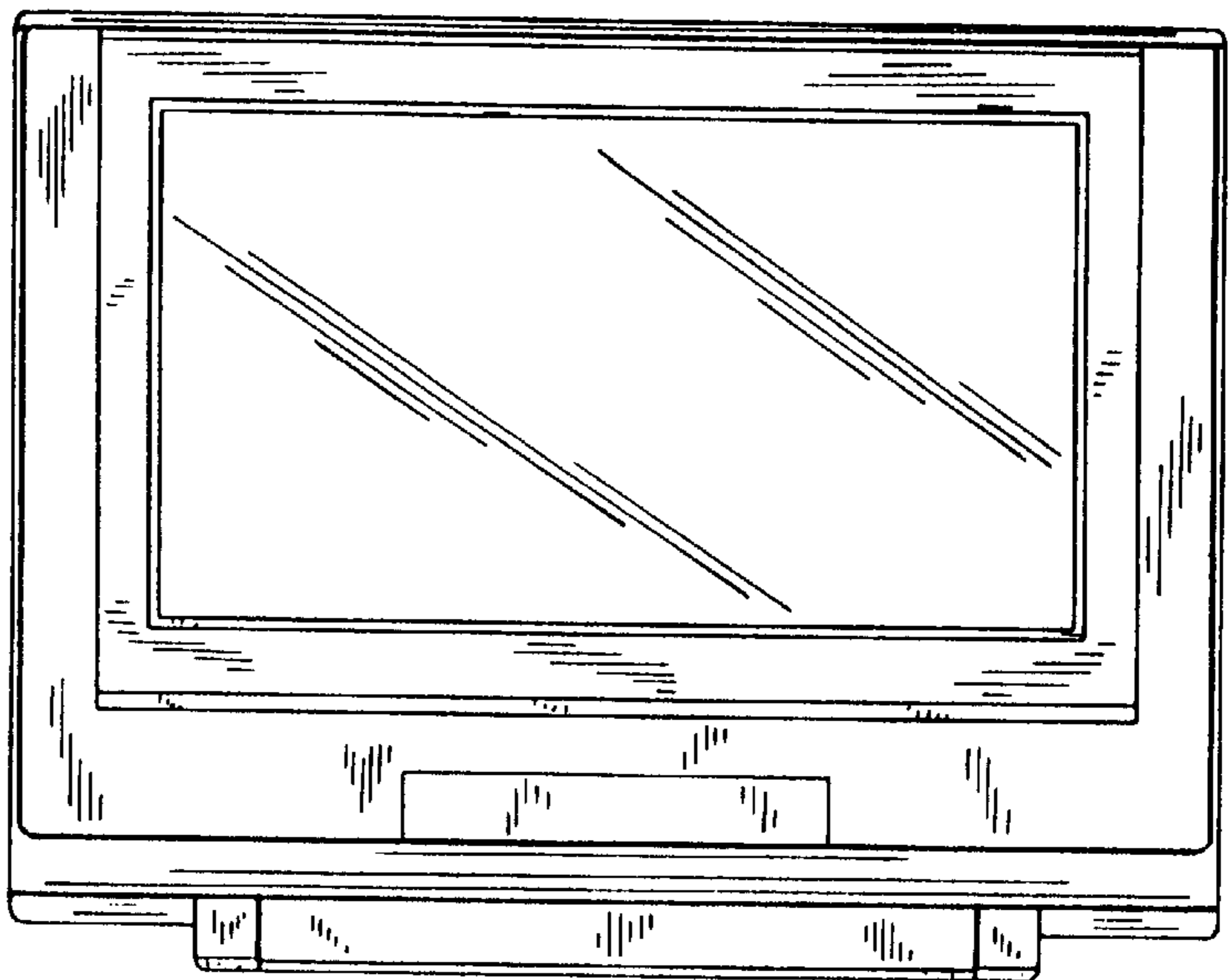

FIG. 5

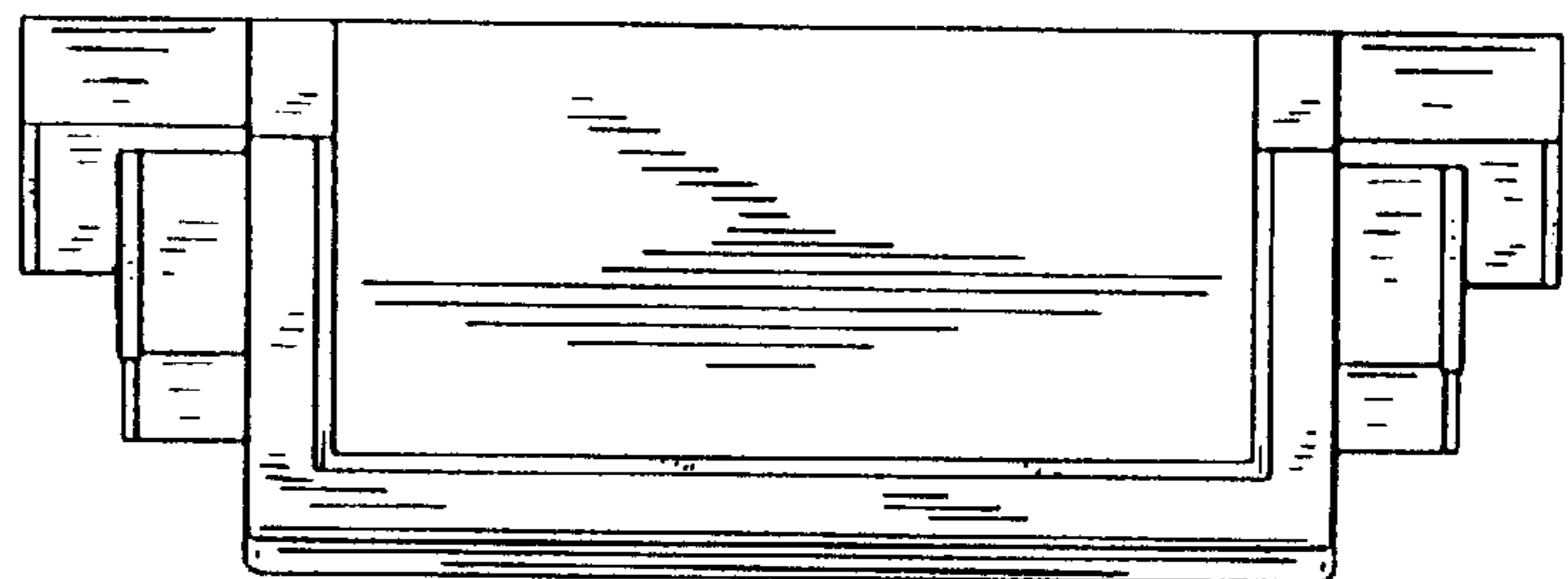

FIG. 6

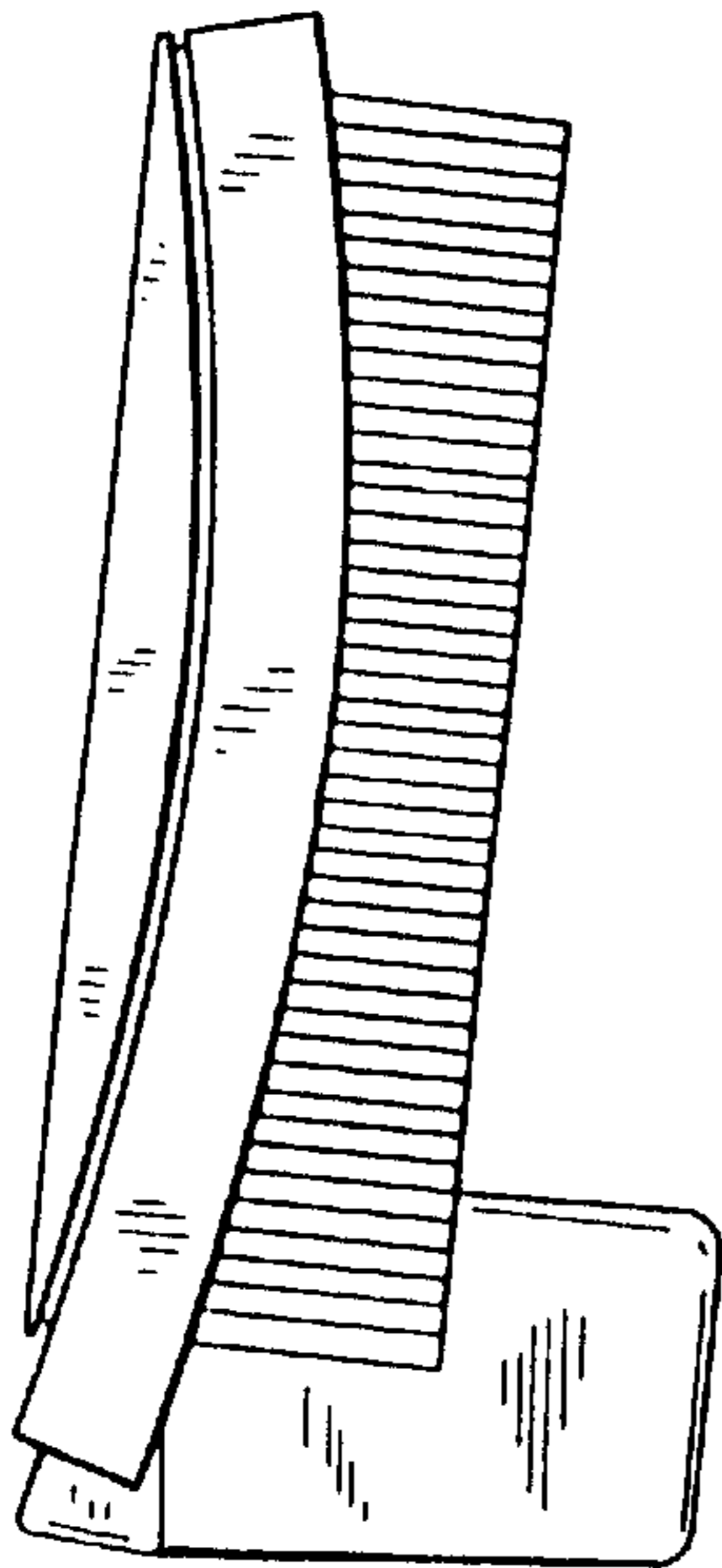

FIG. 7

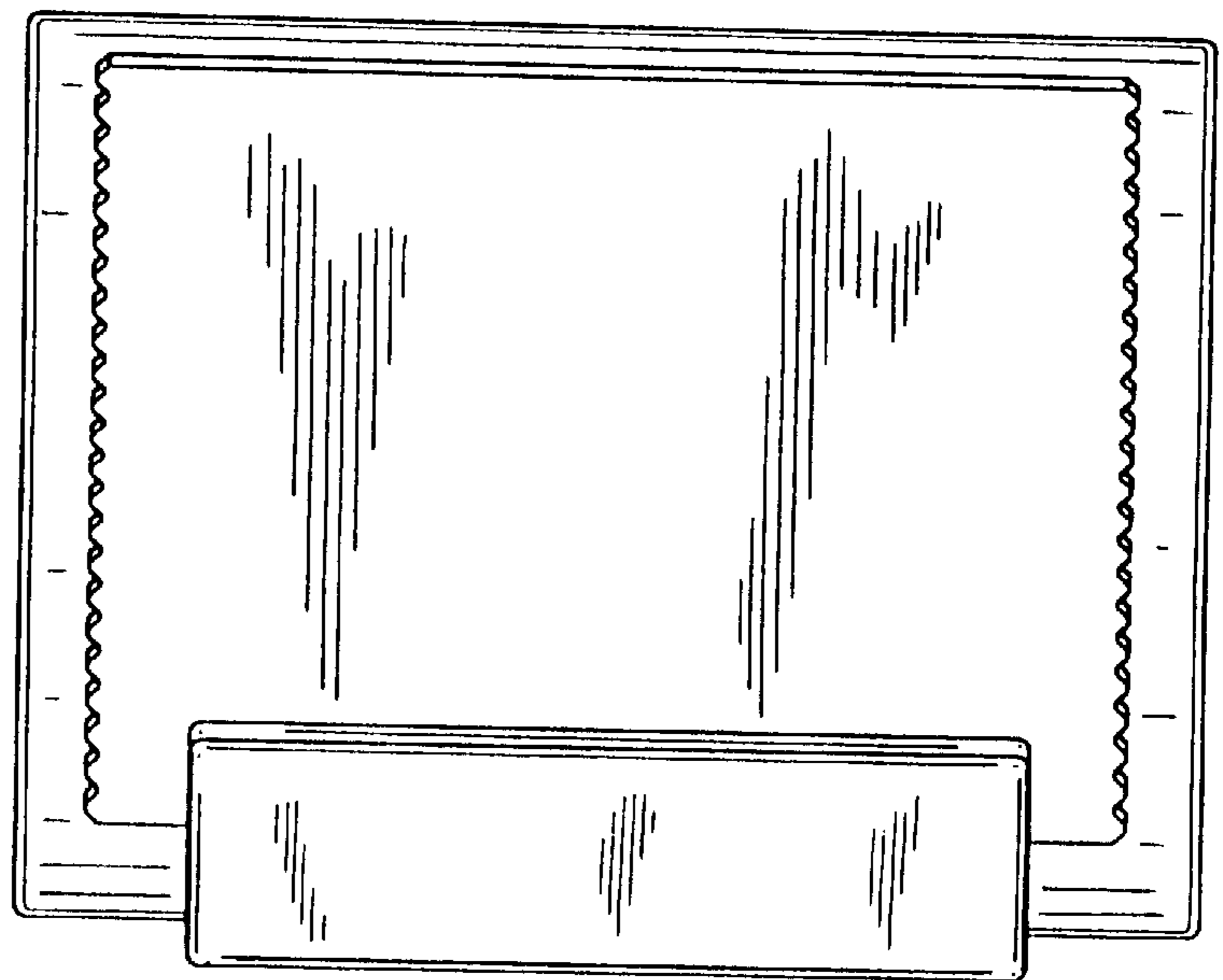

FIG. 8

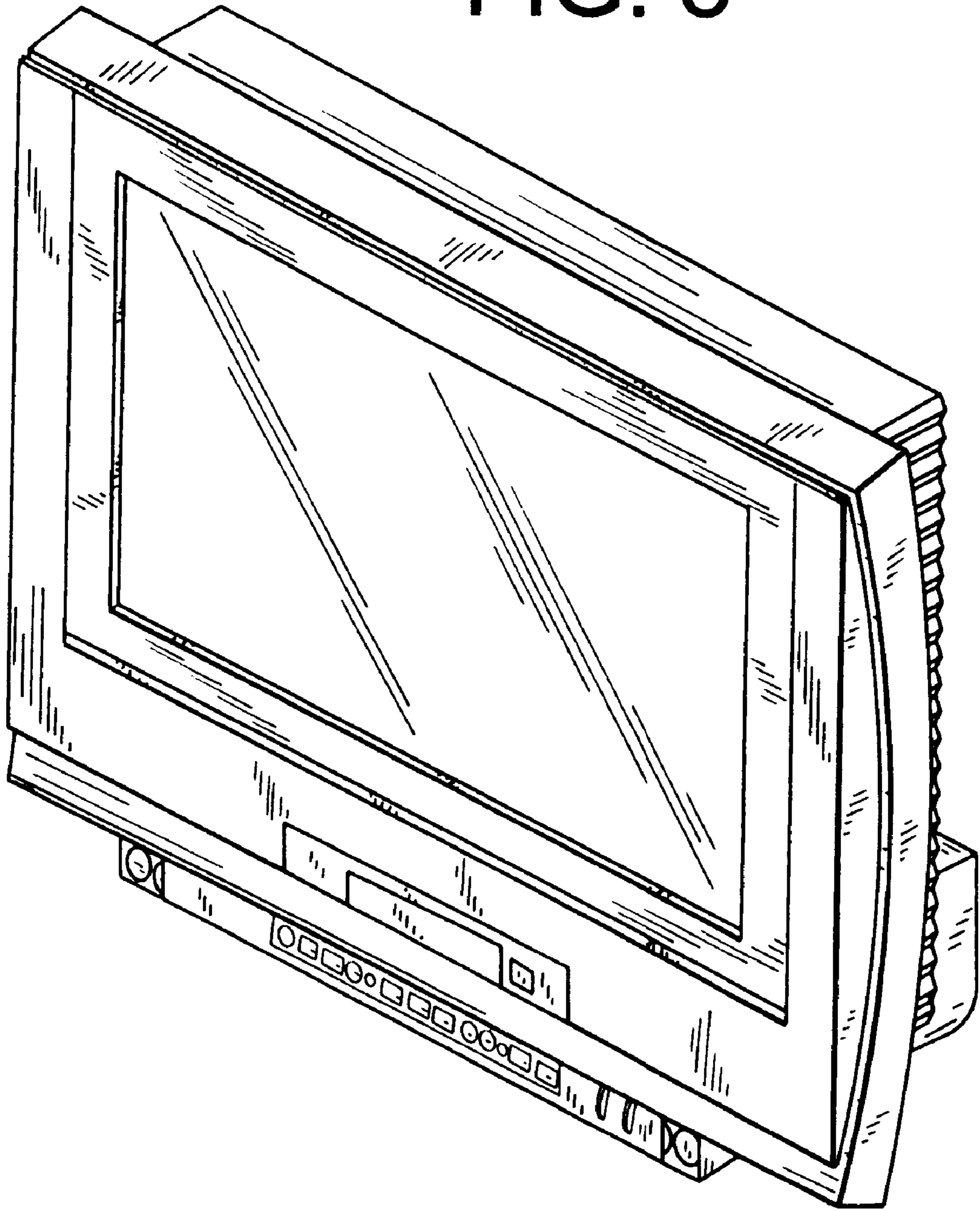

FIG. 9

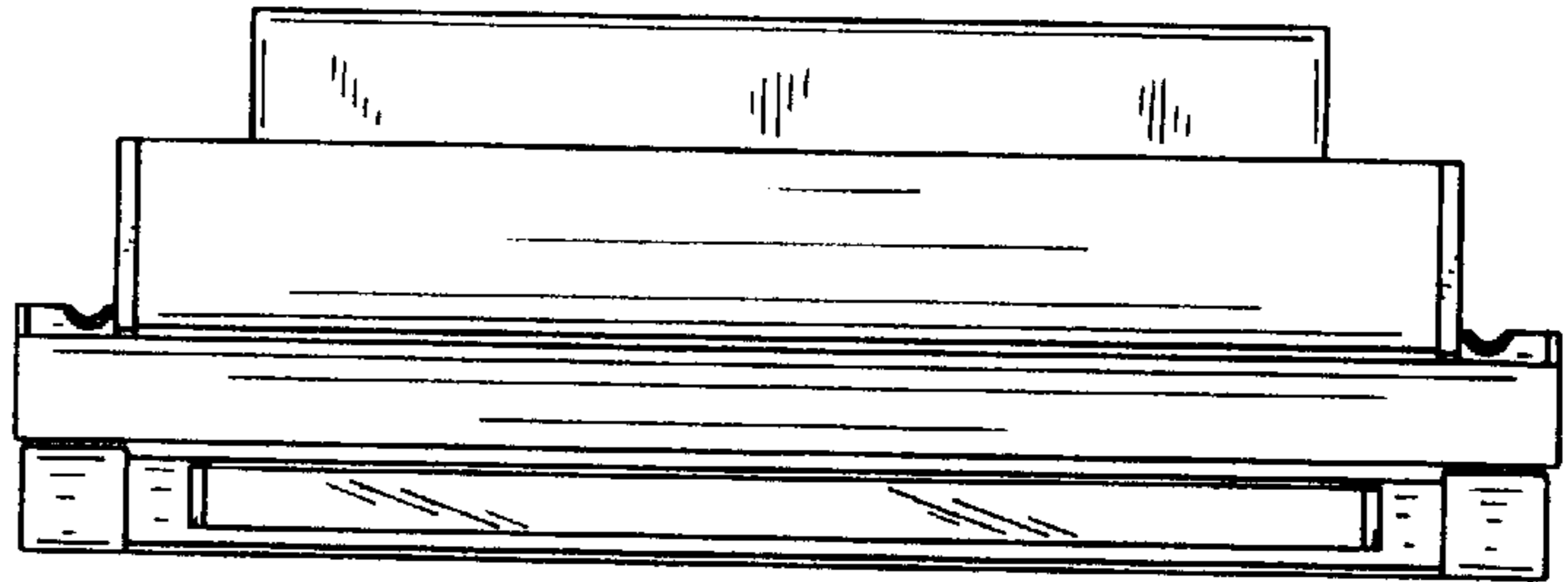

FIG. 10

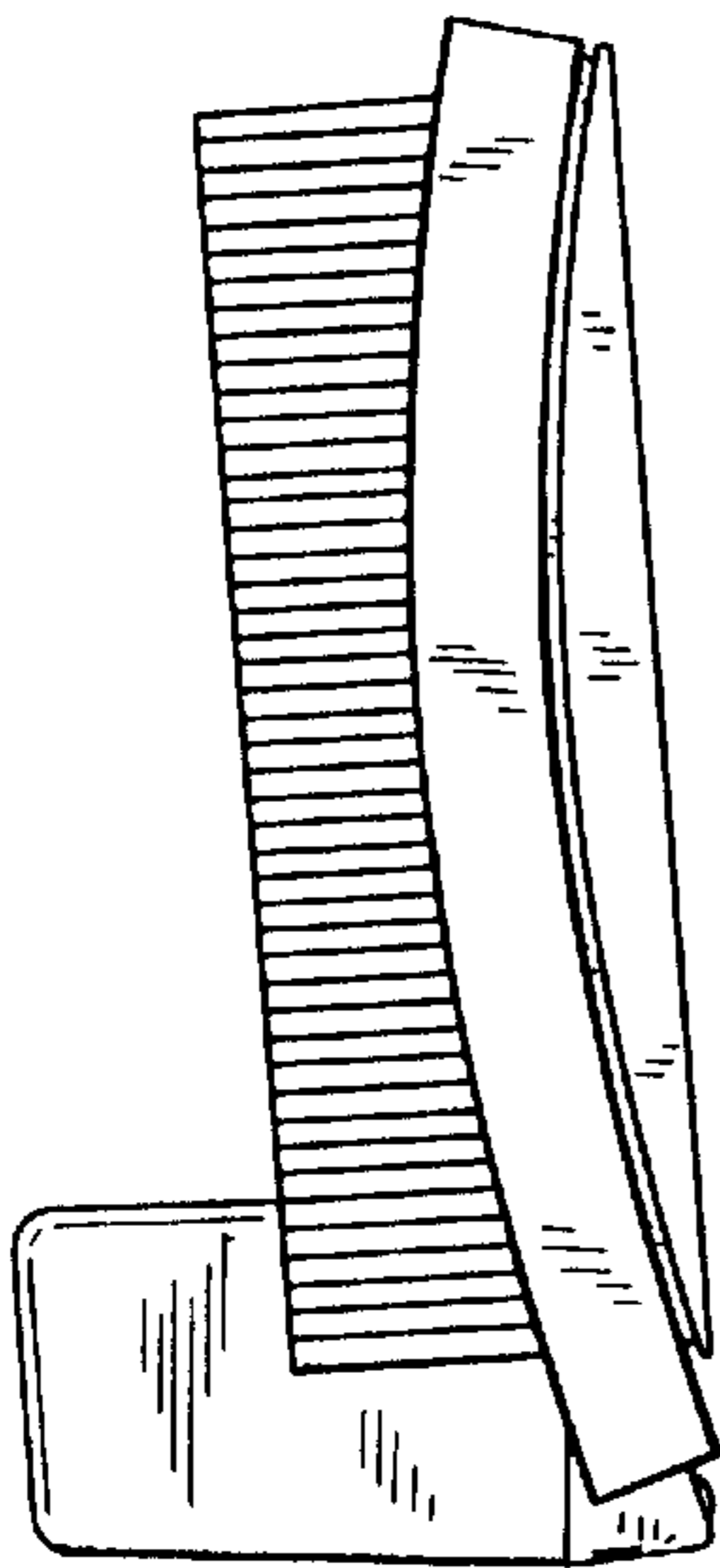

FIG. 11

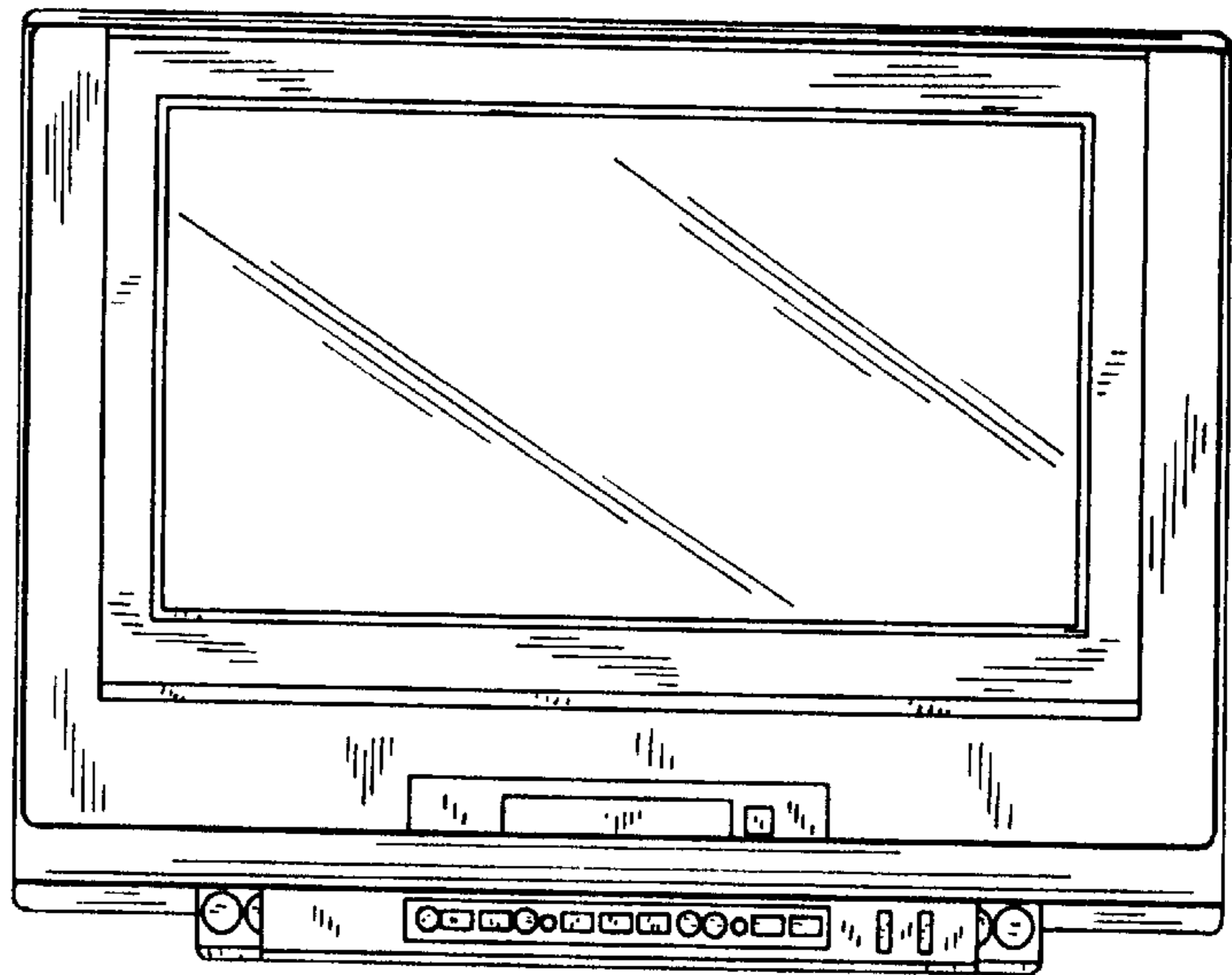

FIG. 12

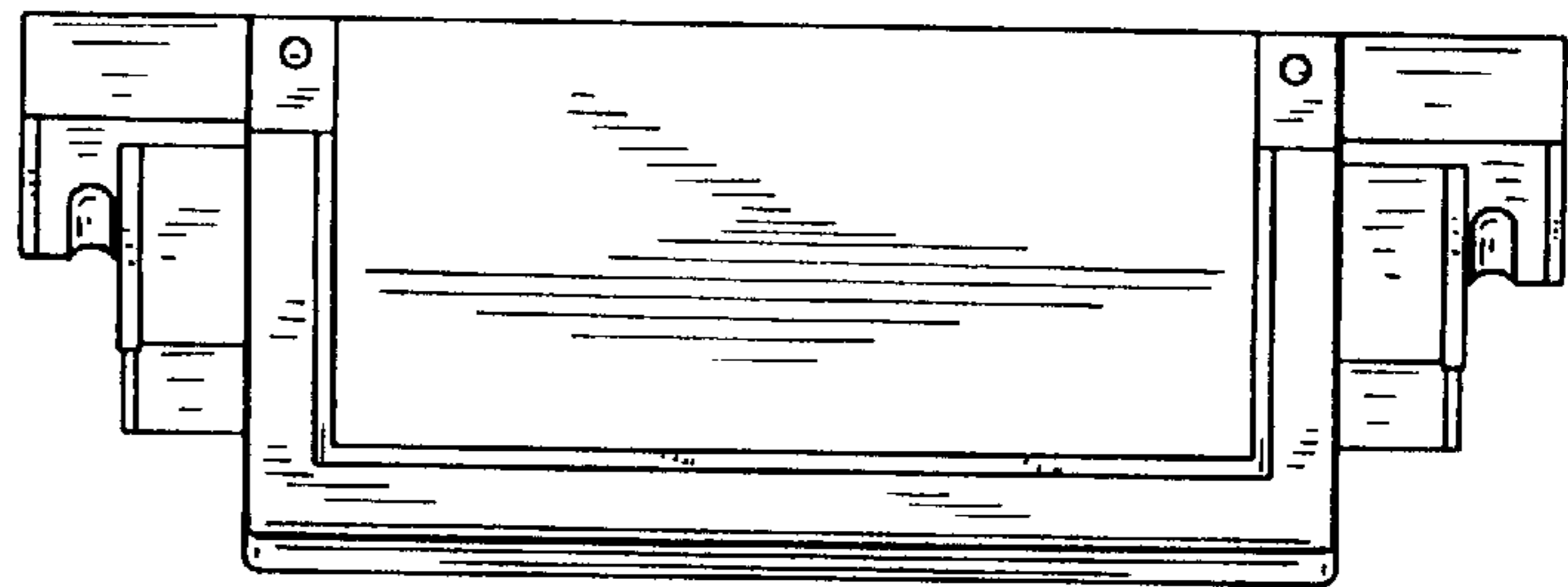

FIG. 13

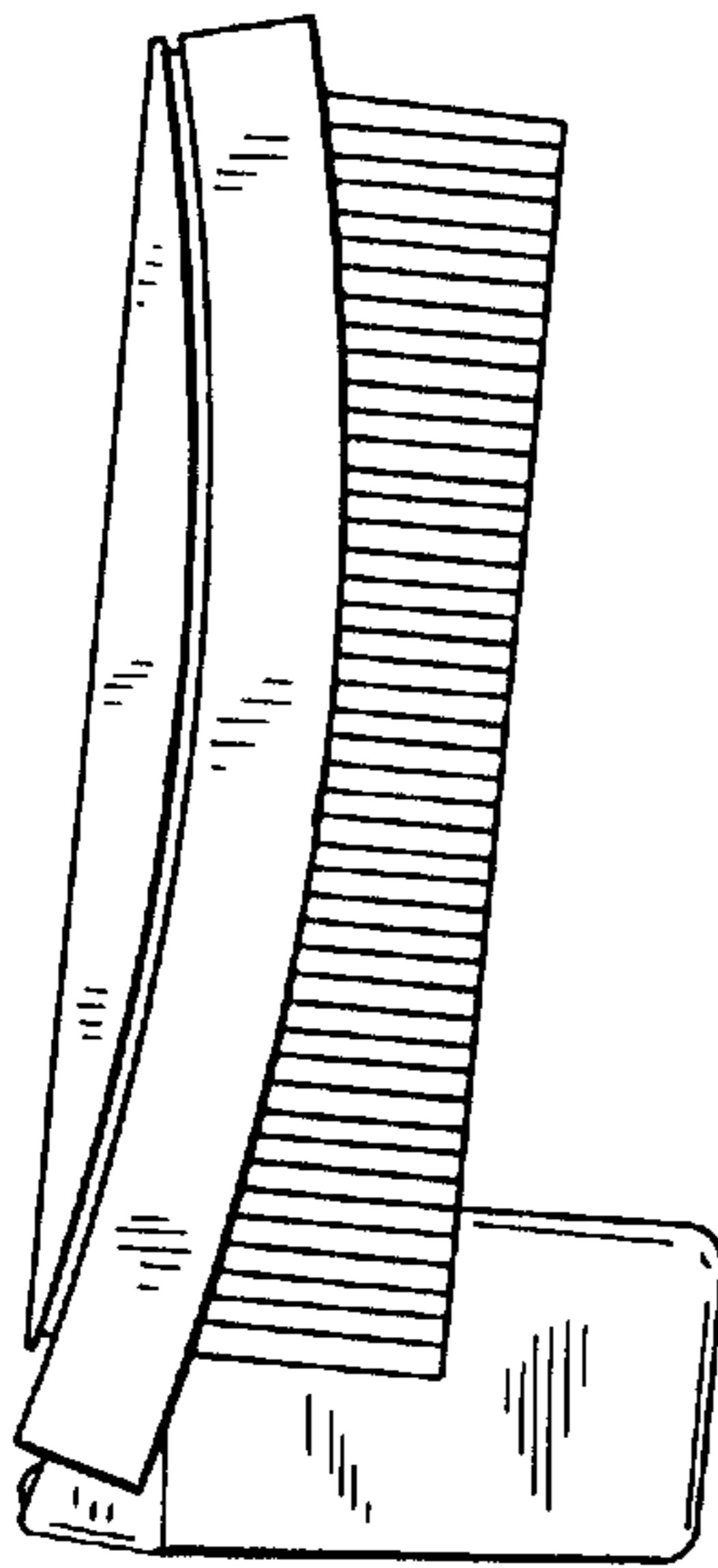

FIG. 14

