



US00D416007S

United States Patent [19] Cavello

[11] **Patent Number: Des. 416,007**

[45] **Date of Patent: ** Nov. 2, 1999**

[54] **COMBINED COMPUTER MONITOR BASE AND DETACHABLE UNIVERSAL SERIAL BUS HUB**

[75] Inventor: **Christopher Cavello**, Austin, Tex.

[73] Assignee: **ADI Corporation**, Tai-Ping, Taiwan

[**] Term: **14 Years**

[21] Appl. No.: **29/089,919**

[22] Filed: **Jun. 23, 1998**

[30] **Foreign Application Priority Data**

Mar. 17, 1998 [TW] Taiwan 87301792

[51] **LOC (6) Cl.** **14-02**

[52] **U.S. Cl.** **D14/114**

[58] **Field of Search** D14/100, 107, D14/113, 108-109, 114; D13/101, 123, 162; 360/97.01, 98.01, 99.12; 361/680-686, 690-696

[56] **References Cited**

U.S. PATENT DOCUMENTS

D. 338,883 8/1993 Melzer et al. D14/114

D. 345,969 4/1994 McKnight et al. D14/114
D. 361,324 8/1995 Rogers D14/107
D. 368,706 4/1996 Miki D14/114
D. 391,942 3/1998 Lee D14/114
D. 393,633 4/1998 Jacobson et al. D14/114
D. 395,290 6/1998 Nakayama et al. D14/107

Primary Examiner—Freda Nunn

Attorney, Agent, or Firm—Brinks Hofer Gilson & Lione

[57] **CLAIM**

The ornamental design for a combined computer monitor base and detachable universal serial bus hub, as shown and described.

DESCRIPTION

FIG. 1 is a perspective view of a combined computer monitor base and detachable universal serial bus hub showing my new design;
FIG. 2 is a front elevational view thereof;
FIG. 3 is a rear elevational view thereof;
FIG. 4 is a left side elevational view thereof;
FIG. 5 is a right side elevational view thereof;
FIG. 6 is a top plan view thereof;
FIG. 7 is a bottom plan view thereof; and,
FIG. 8 is a perspective view when in use.

1 Claim, 5 Drawing Sheets

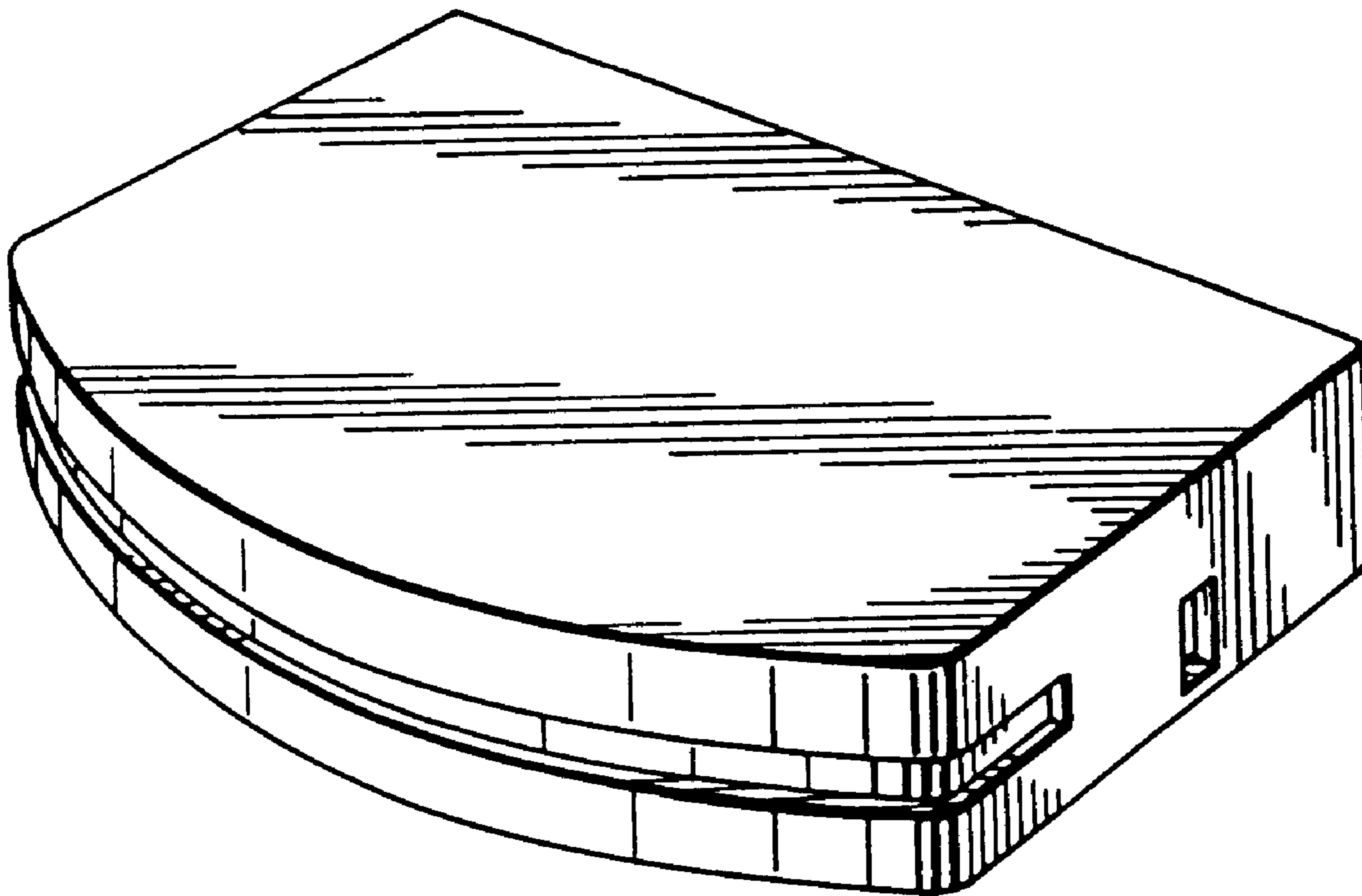

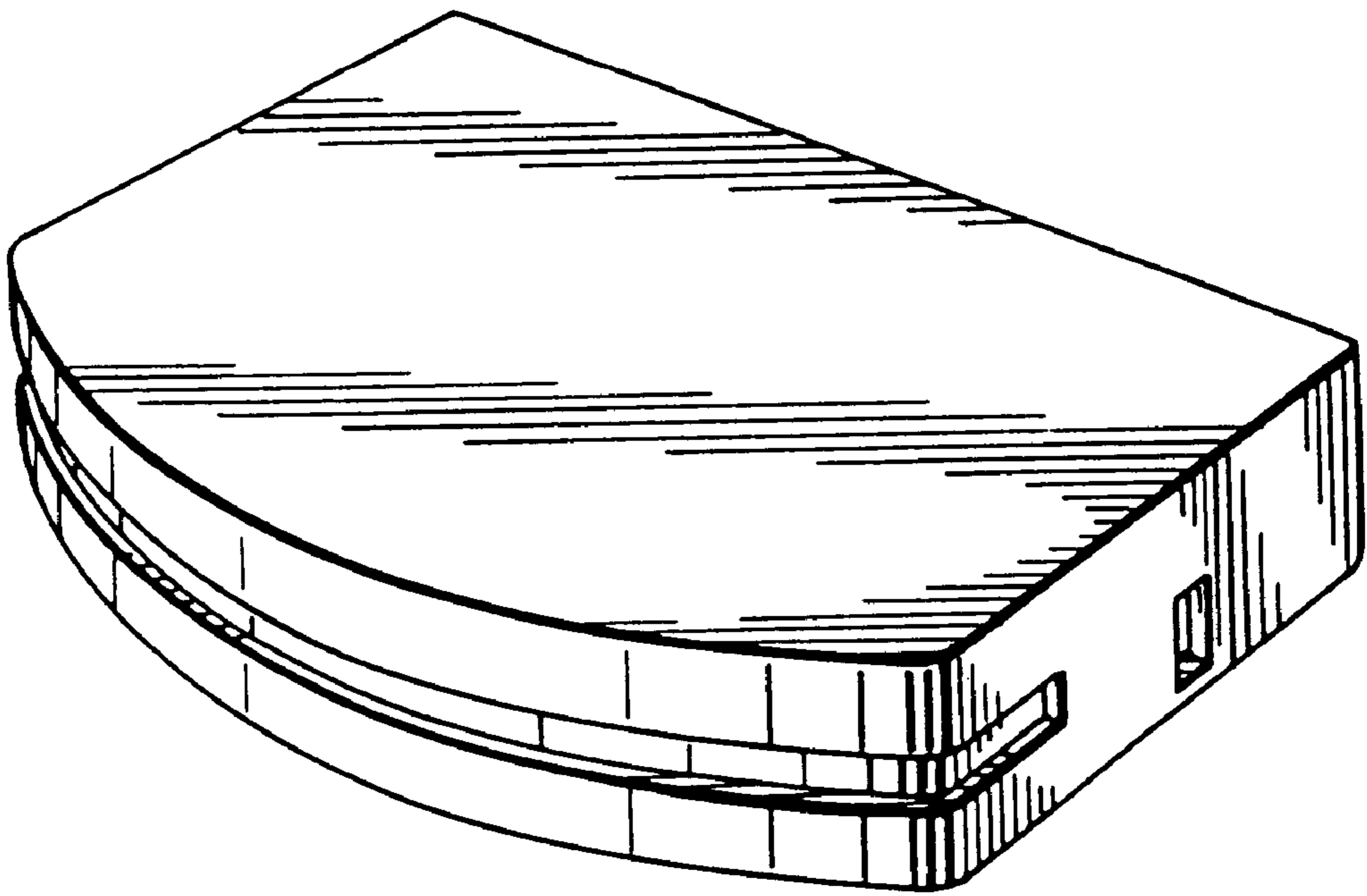

FIG. 1

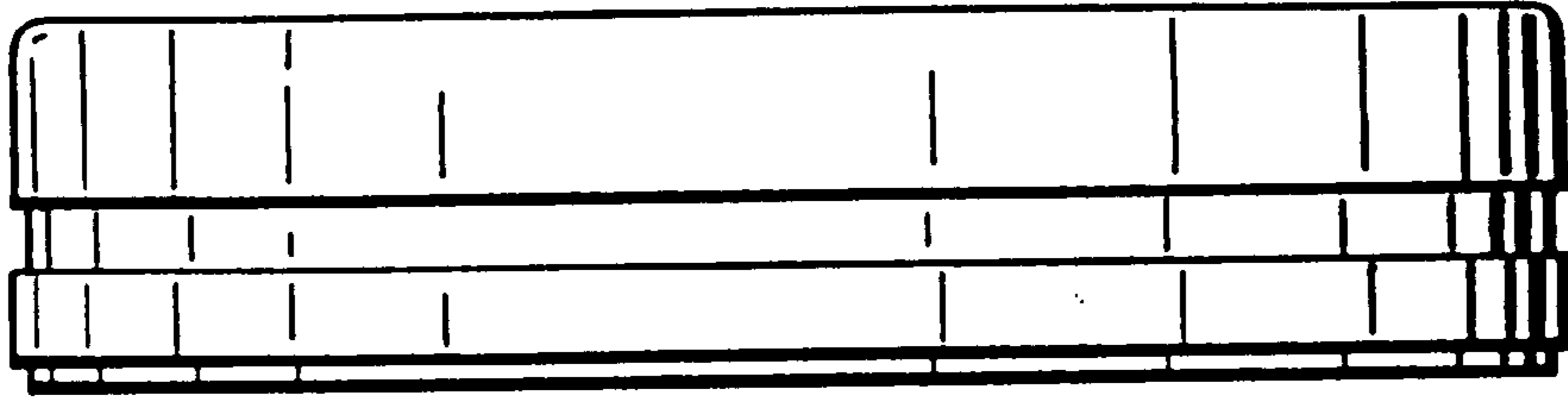

FIG. 2

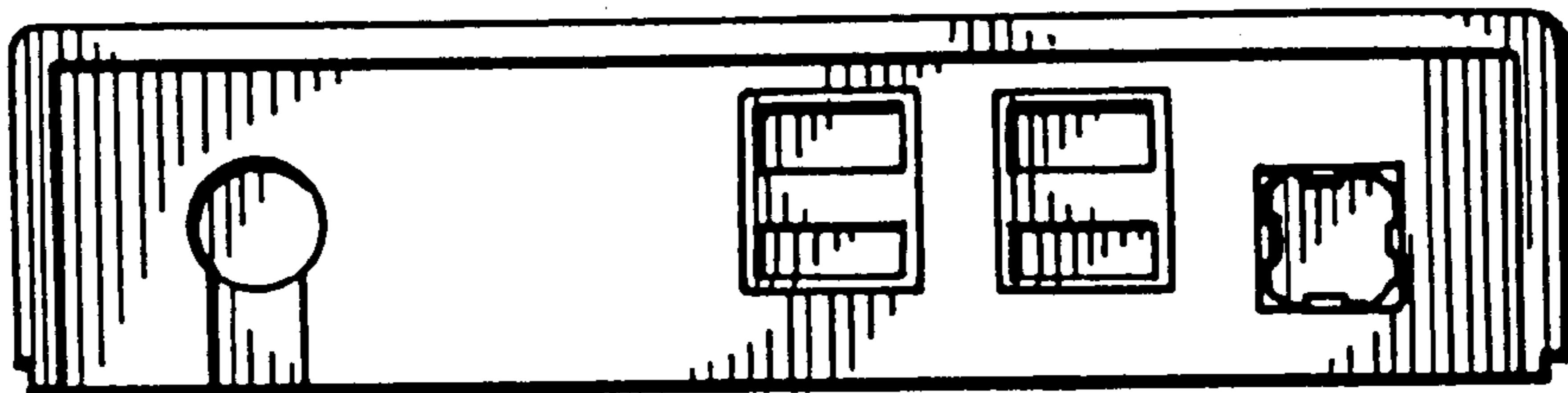

FIG. 3

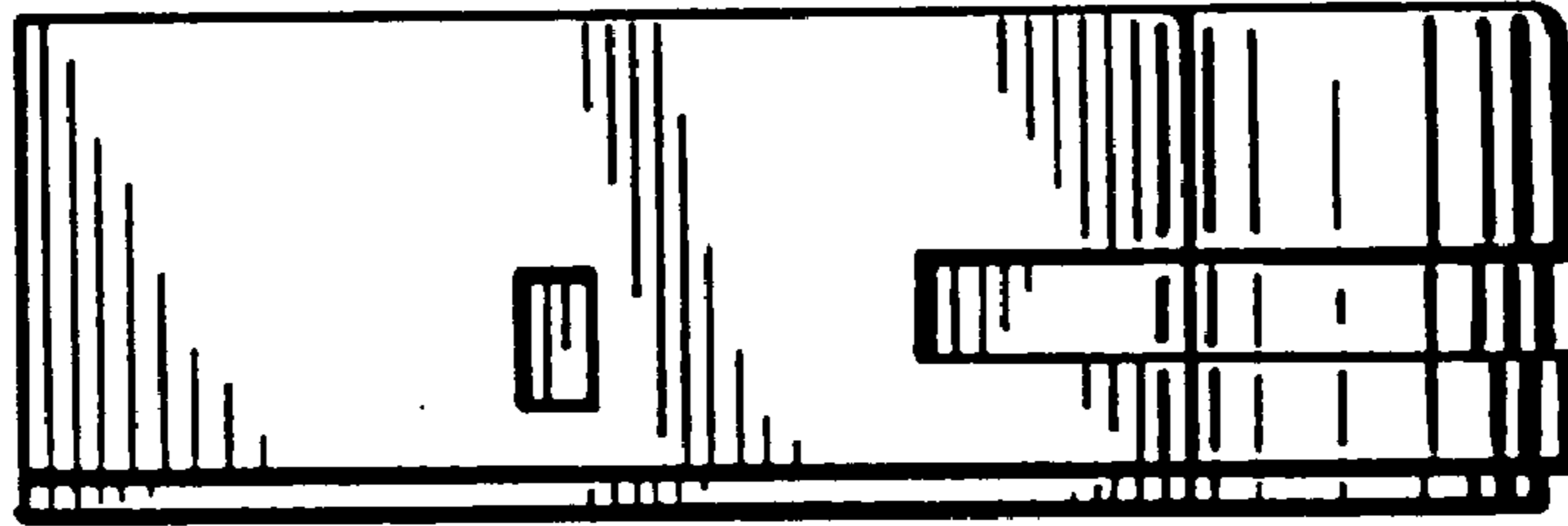

FIG. 4

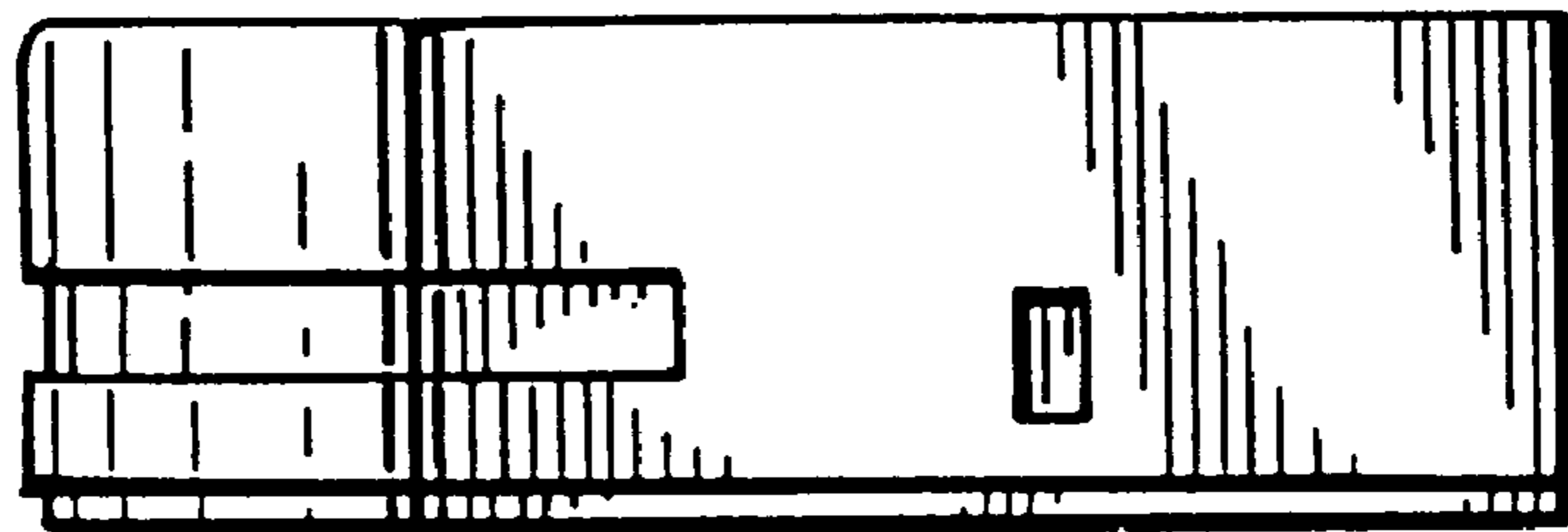

FIG. 5

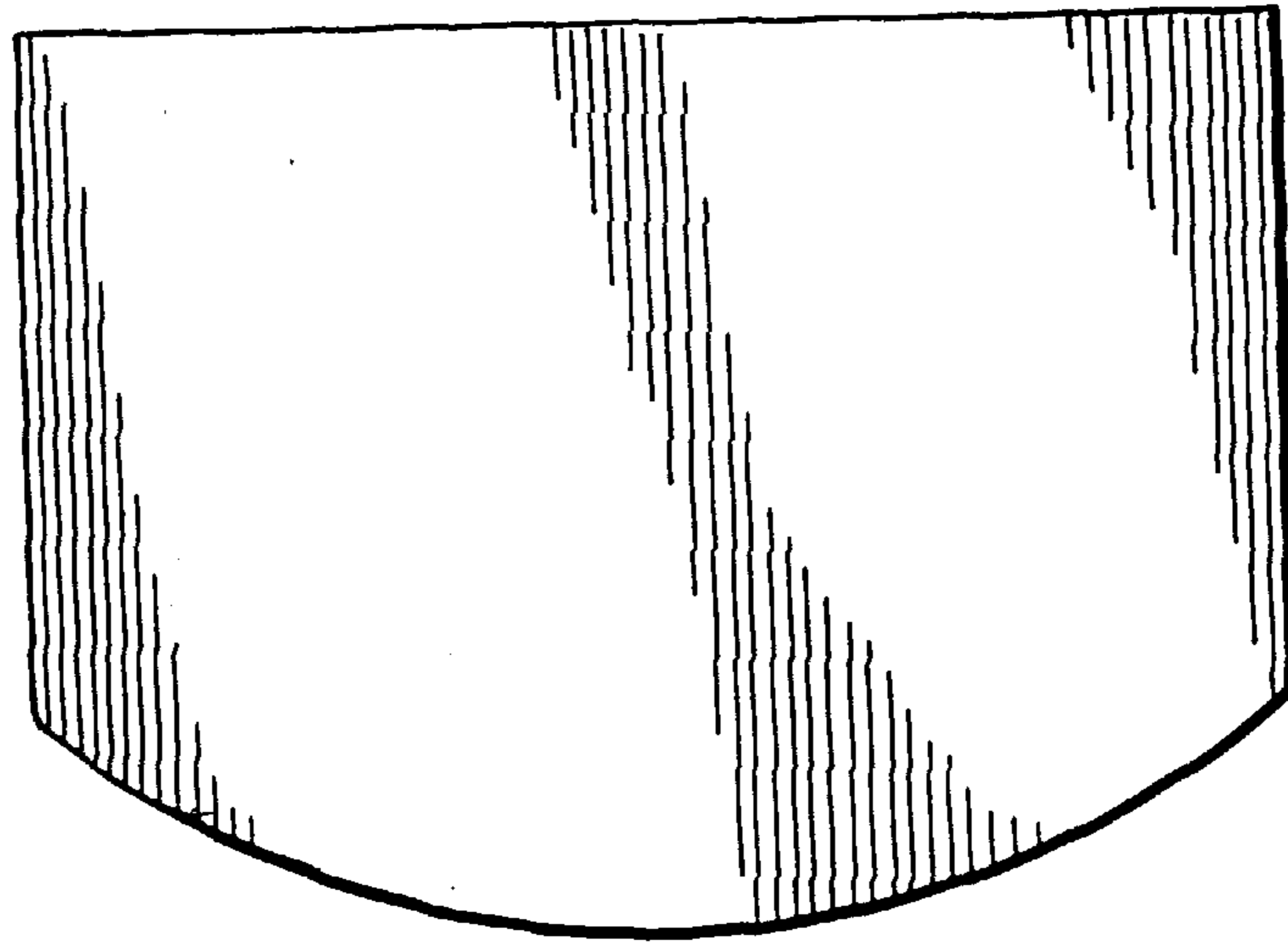

FIG. 6

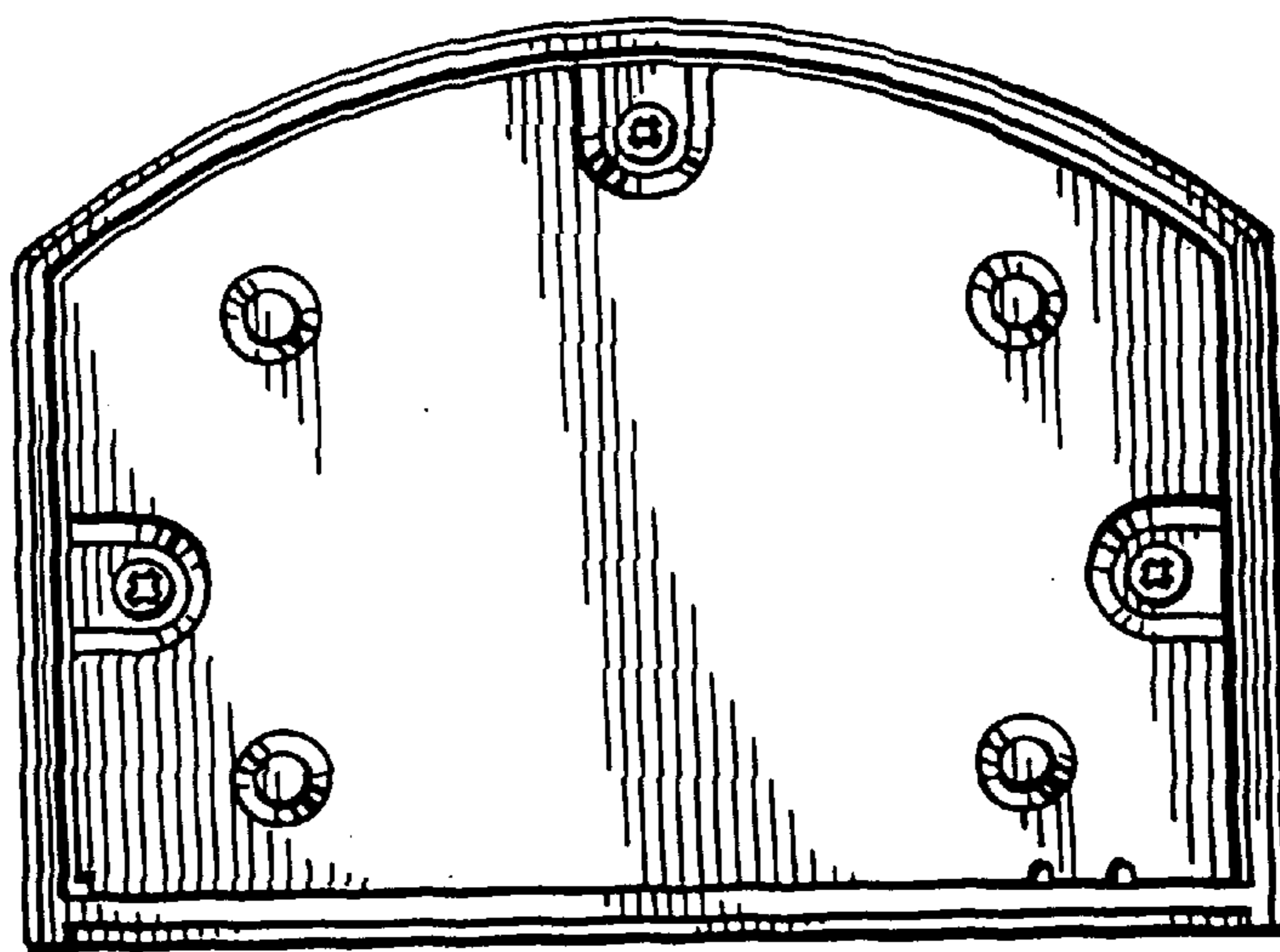

FIG. 7

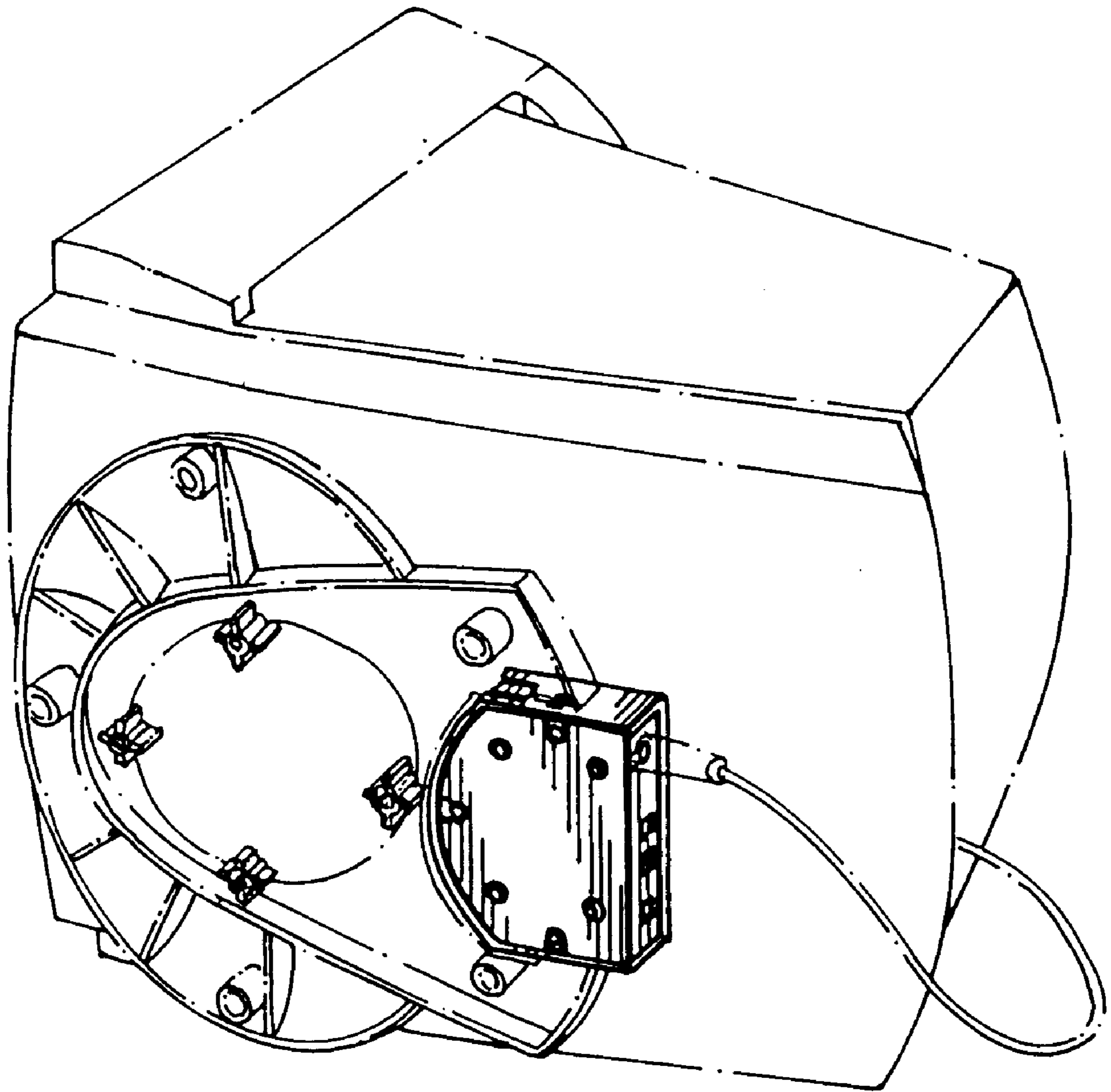

FIG. 8