



US00D416005S

United States Patent [19] Paek

[11] **Patent Number: Des. 416,005**

[45] **Date of Patent: ** Nov. 2, 1999**

[54] **MONITOR**

D. 377,483 1/1997 Takami et al. D14/113
D. 390,545 2/1998 Chang D14/113

[75] Inventor: **Woon San Paek**, Seoul, Rep. of Korea

[73] Assignee: **LG Electronics Inc.**, Seoul, Rep. of Korea

Primary Examiner—Freda Nunn

[**] Term: **14 Years**

[57] CLAIM

[21] Appl. No.: **29/085,767**

The ornamental design for a monitor, as shown and described.

[22] Filed: **Mar. 30, 1998**

DESCRIPTION

[30] Foreign Application Priority Data

Sep. 30, 1997 [KR] Rep. of Korea 97-20678

FIG. 1 is a perspective view of the monitor showing the new design;

[51] **LOC (6) Cl.** **14-02**

FIG. 2 is a front view thereof;

[52] **U.S. Cl.** **D14/113; D14/126**

FIG. 3 is a rear elevational view thereof;

[58] **Field of Search** D14/100, 101,
D14/106, 113, 124-129; 248/918-924;
341/12; 345/104, 133, 156, 168, 87, 173,
901-905; 348/180, 184, 325, 739

FIG. 4 is a bottom plan view thereof;

FIG. 5 is a top plan view thereof;

FIG. 6 is a left-side elevational view thereof; and,

FIG. 7 is a right-side elevational view thereof.

[56] References Cited

U.S. PATENT DOCUMENTS

D. 366,473 1/1996 Behar D14/113

1 Claim, 4 Drawing Sheets

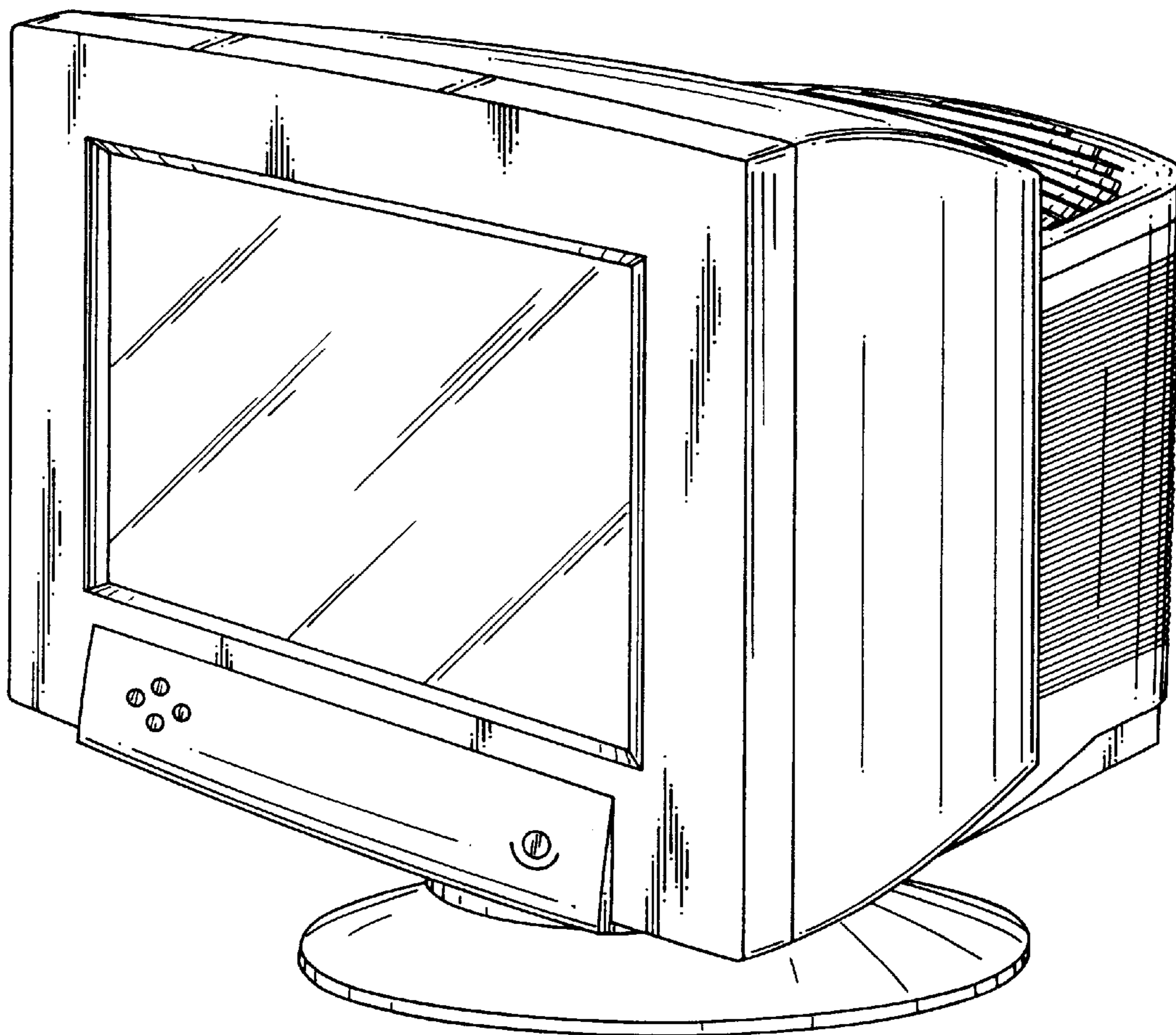

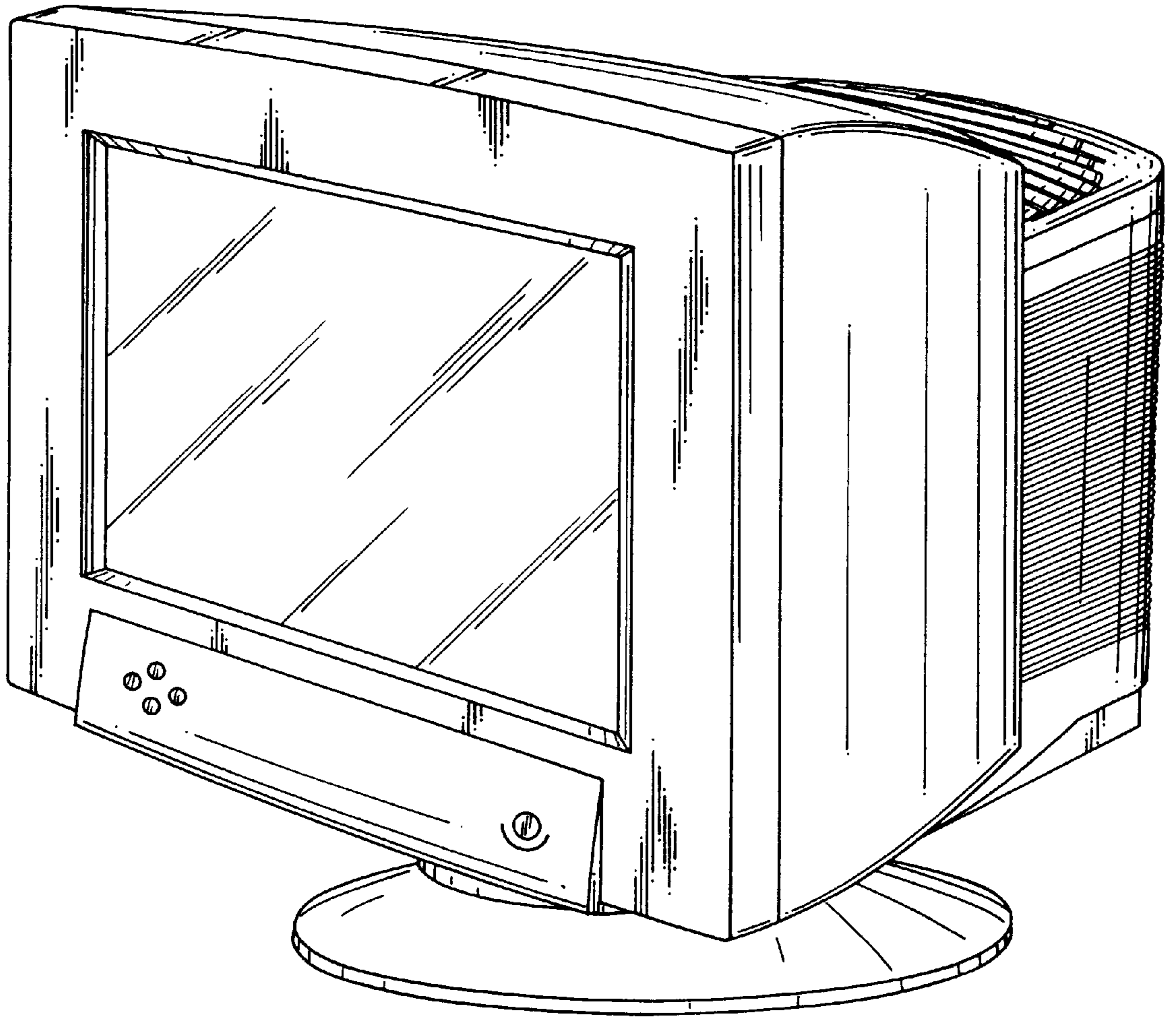

FIG. 1

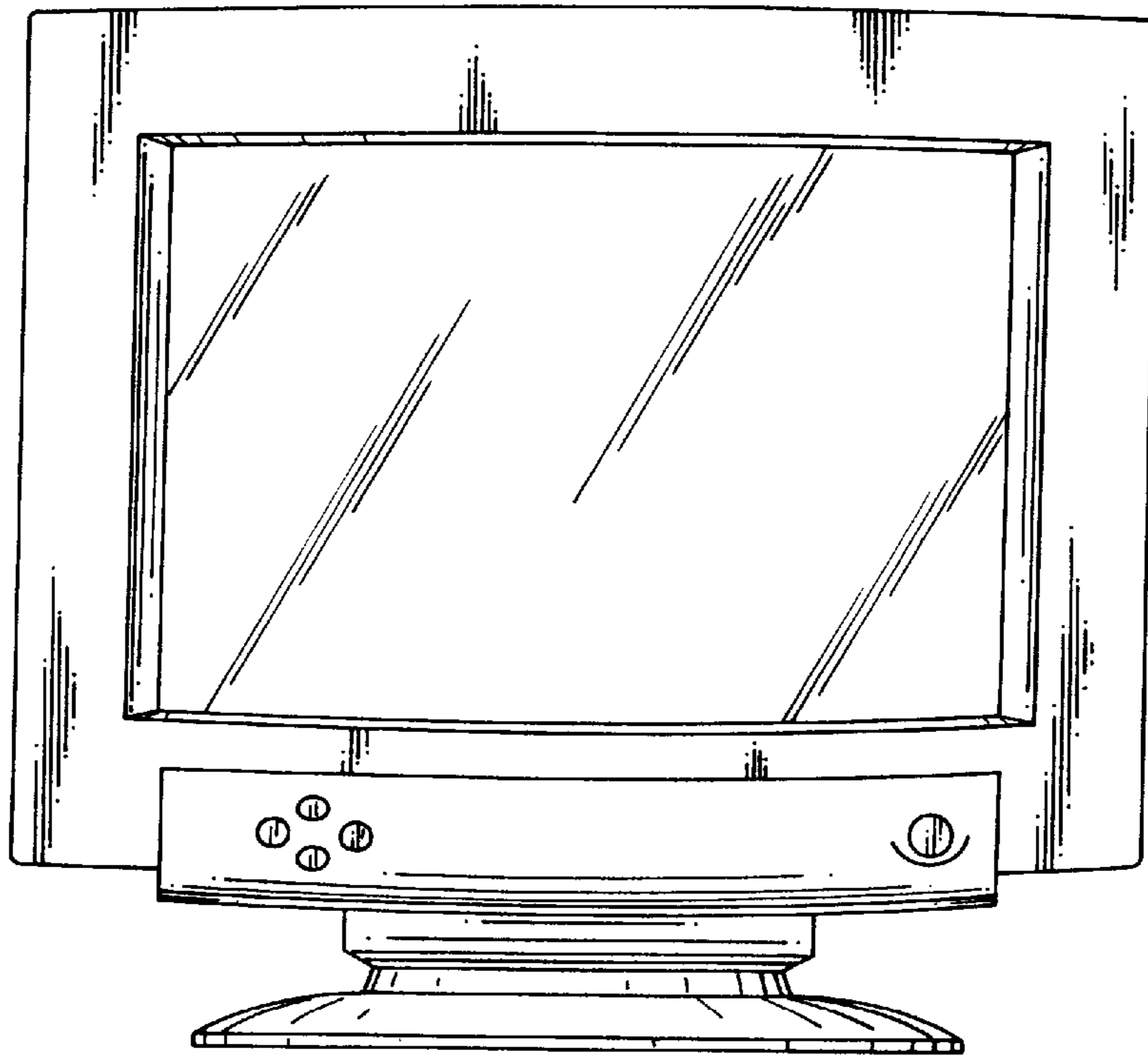

FIG. 2

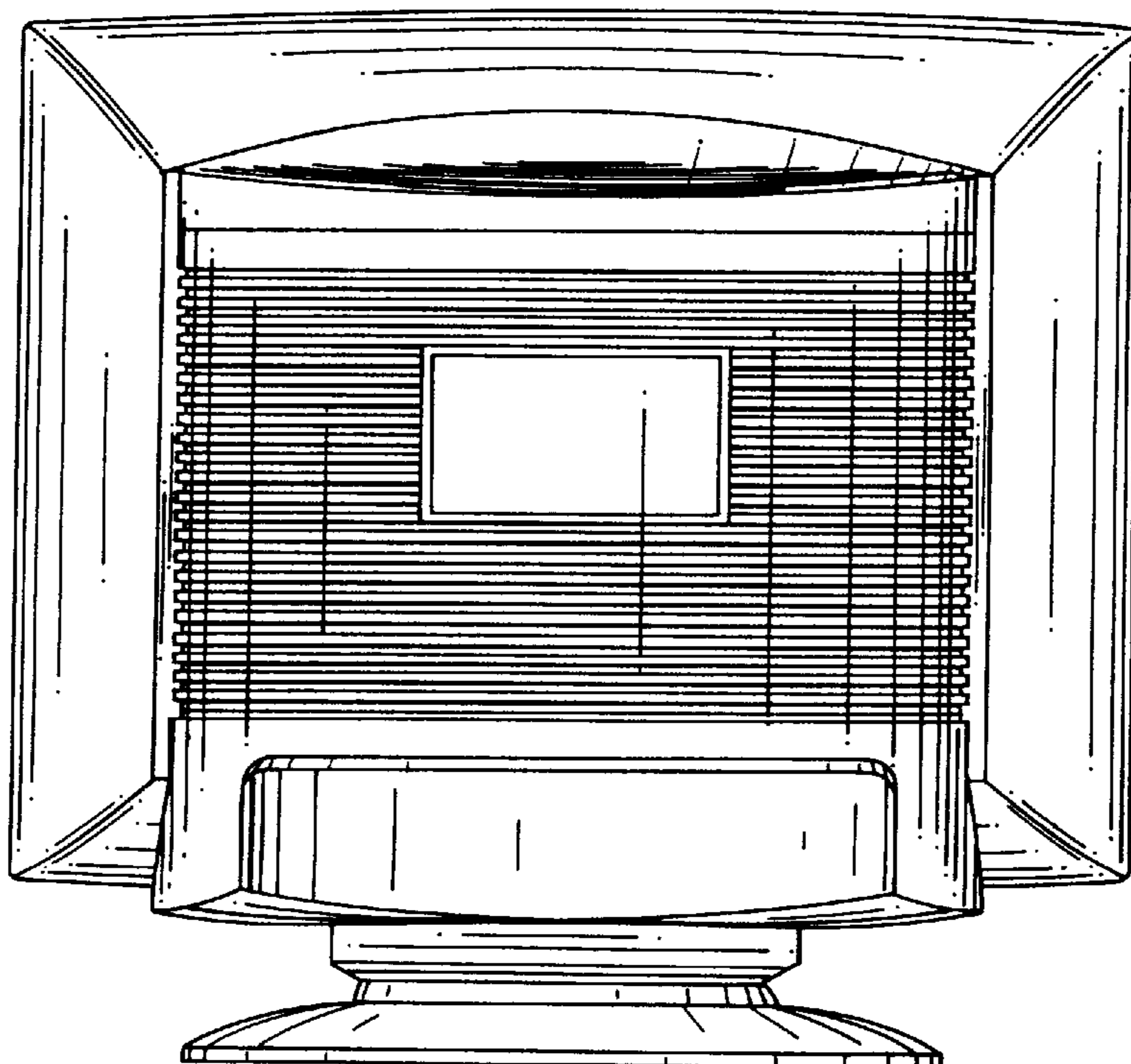

FIG. 3

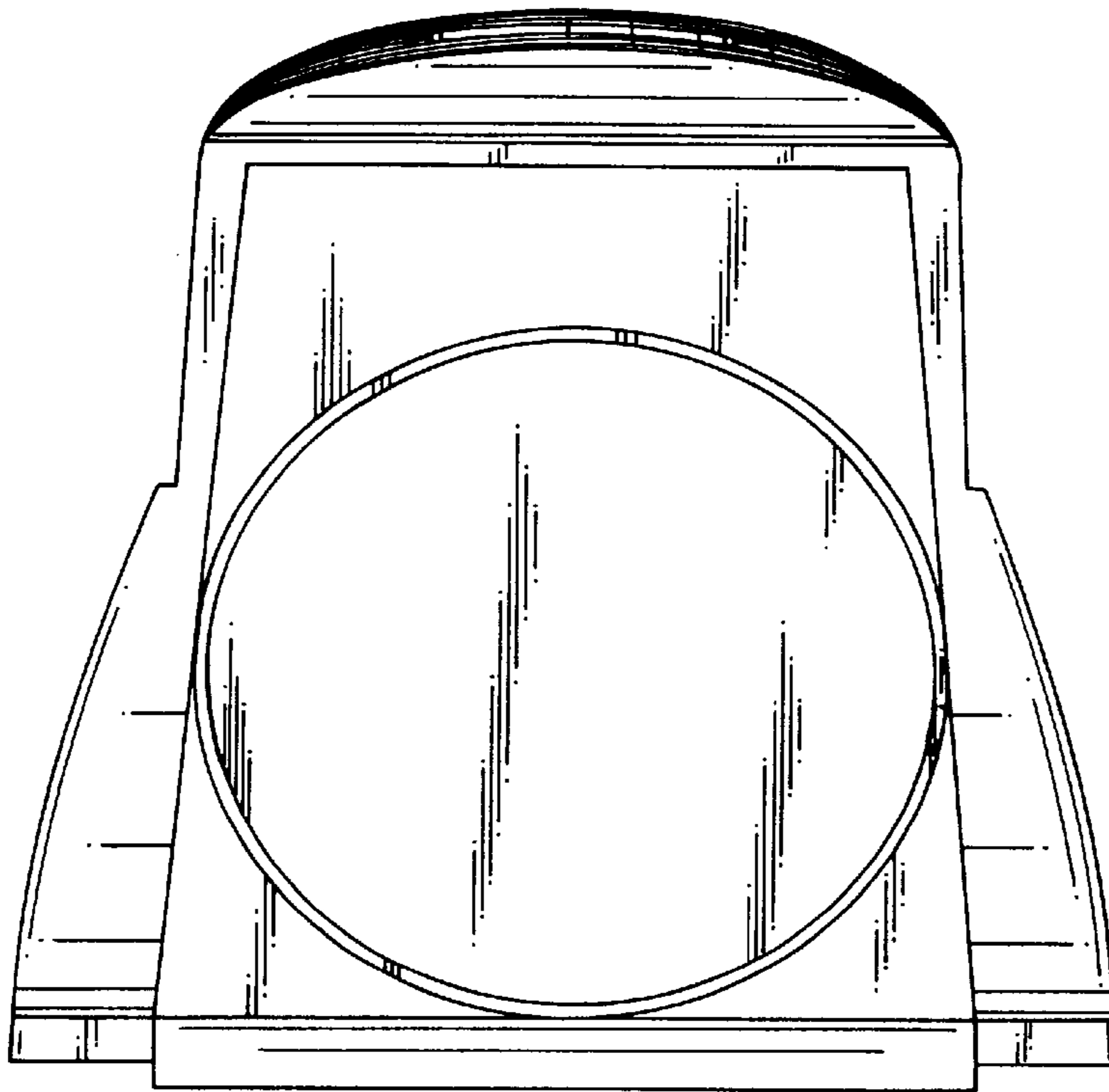

FIG. 4

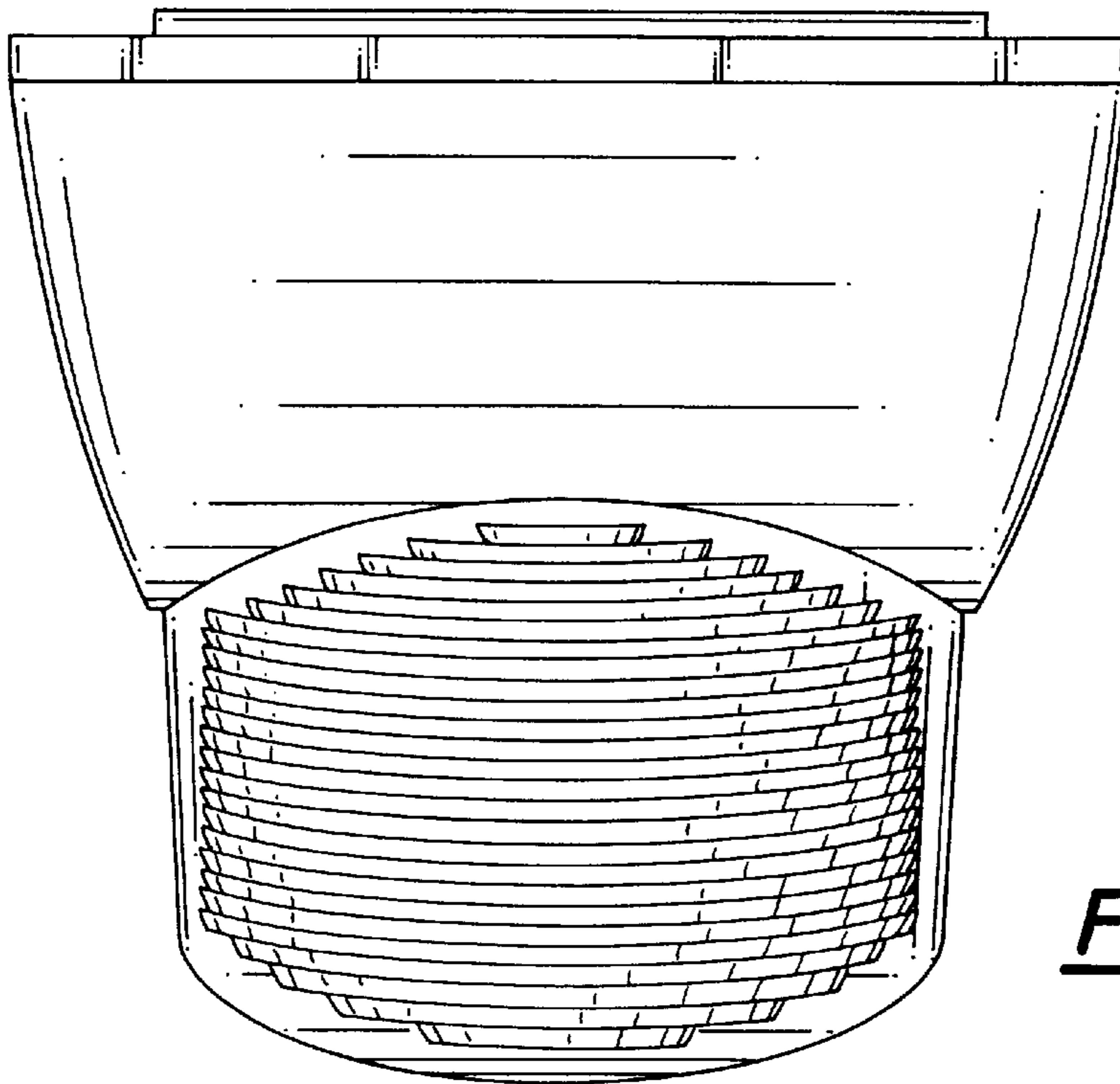

FIG. 5

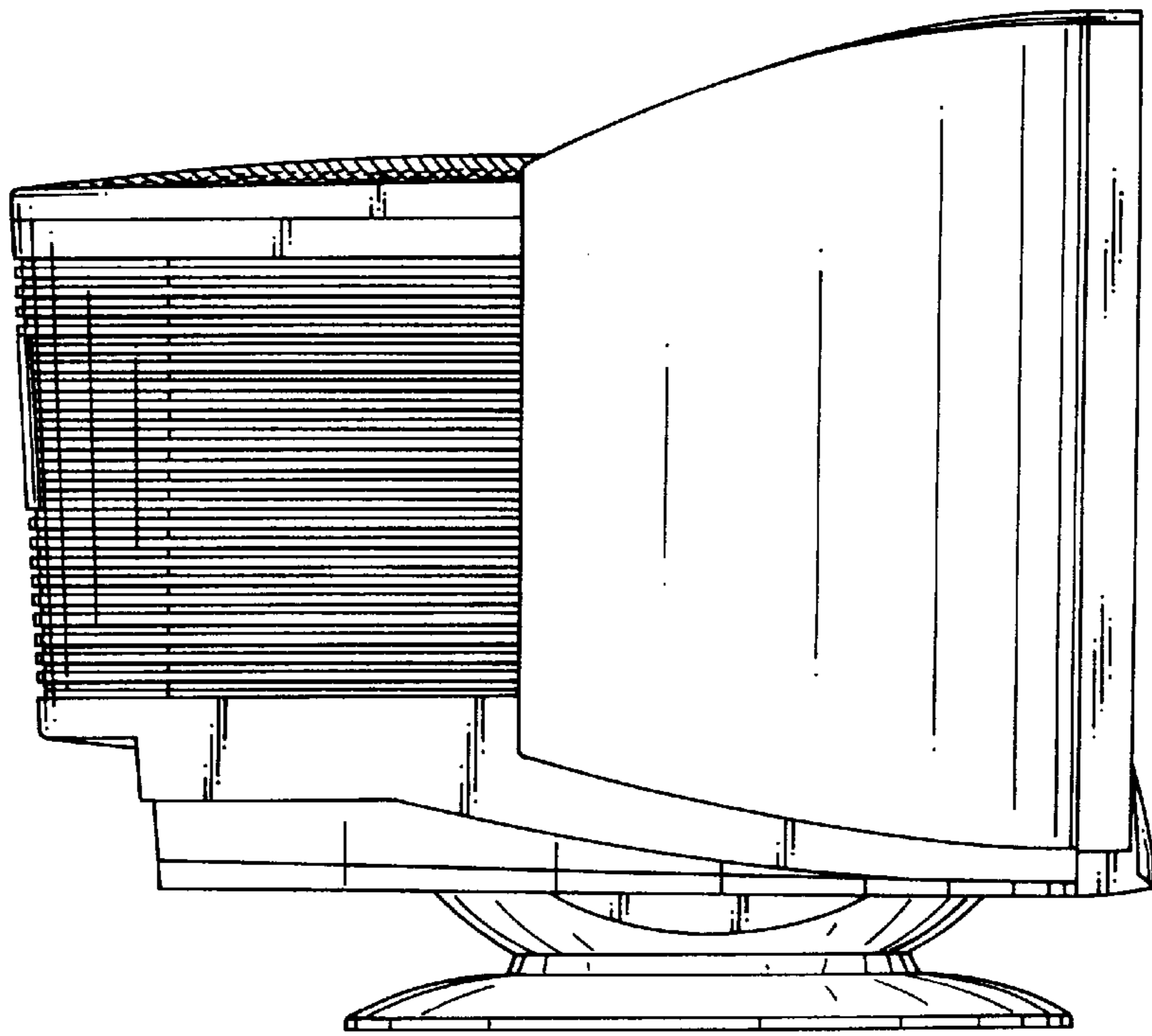

FIG. 6

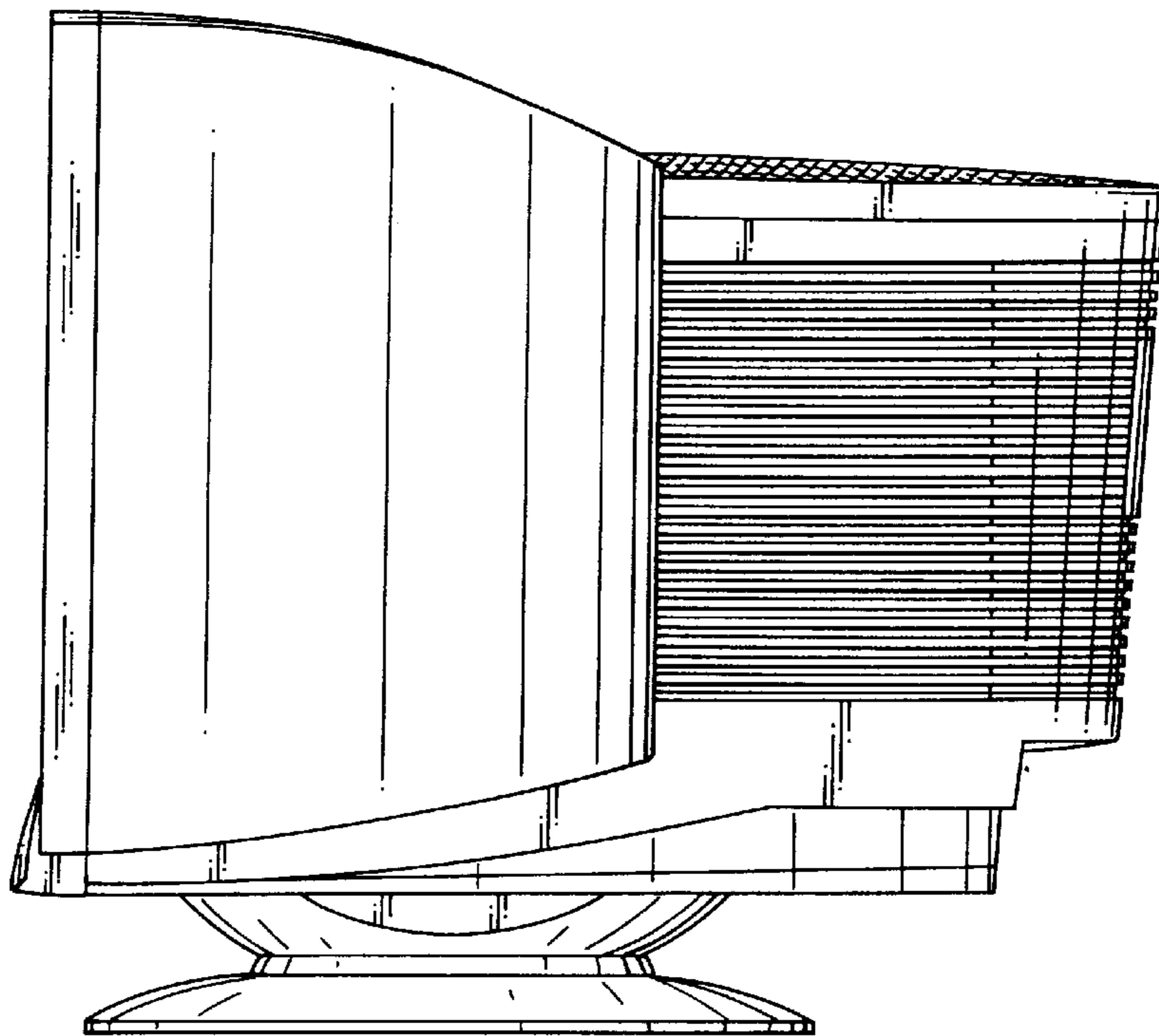

FIG. 7