



US00D415995S

United States Patent [19]

Kanehl, Jr.

[11] Patent Number: **Des. 415,995**

[45] Date of Patent: **** Nov. 2, 1999**

[54] **ADJUSTABLE FOOD AND BEVERAGE CAR TRAY**

[76] Inventor: **Donald Kanehl, Jr.**, 240 Hewlett Ave., East Patchogue, N.Y. 11772

[**] Term: **14 Years**

[21] Appl. No.: **29/080,570**

[22] Filed: **Dec. 9, 1997**

[51] **LOC (6) Cl.** **12-16**

[52] **U.S. Cl.** **D12/419; D12/416; D12/425**

[58] **Field of Search** D12/400, 415-416, D12/419-426; D6/335-336, 406; 224/275, 497-499, 482; 297/125, 135, 146, 188.1, 463.1, 463.2; 296/37.8, 37.13; 108/46.47; D7/553.4

[56] **References Cited**

U.S. PATENT DOCUMENTS

D. 204,999	6/1966	Edwards	D12/419
D. 260,832	9/1981	Verdesca et al.	D12/425
D. 328,669	8/1992	Sletvold	D12/425 X
D. 340,339	10/1993	Kean et al.	D12/416
D. 341,249	11/1993	Scheurer	D12/419
D. 344,625	3/1994	Berry	D12/416
D. 360,183	7/1995	Girandola	D12/425

D. 380,727	7/1997	Gilstrap	D12/425
D. 393,242	4/1998	Wood	D12/416
2,889,051	6/1959	Kramer	108/46 X
4,858,796	8/1989	Roth	108/46 X
5,106,003	4/1992	Ma	224/482
5,148,755	9/1992	Morales	108/47
5,678,741	10/1997	Schieber	224/275

Primary Examiner—James Gandy
Assistant Examiner—Stacia Sinuik
Attorney, Agent, or Firm—Galgano & Burke

[57] **CLAIM**

The ornamental design for an adjustable food and beverage car tray, as shown and described.

DESCRIPTION

FIG. 1 is a top, side and front perspective view of an adjustable food and beverage car tray, showing my new design;
FIG. 2 is a top view thereof.
FIG. 3 is an side elevational view thereof;
FIG. 4 is a front elevational view thereof;
FIG. 5 is a rear elevational view thereof; and,
FIG. 6 is a bottom view thereof.
The broken line showing of environment is for illustrative purposes only and forms no part of the claimed design.

1 Claim, 5 Drawing Sheets

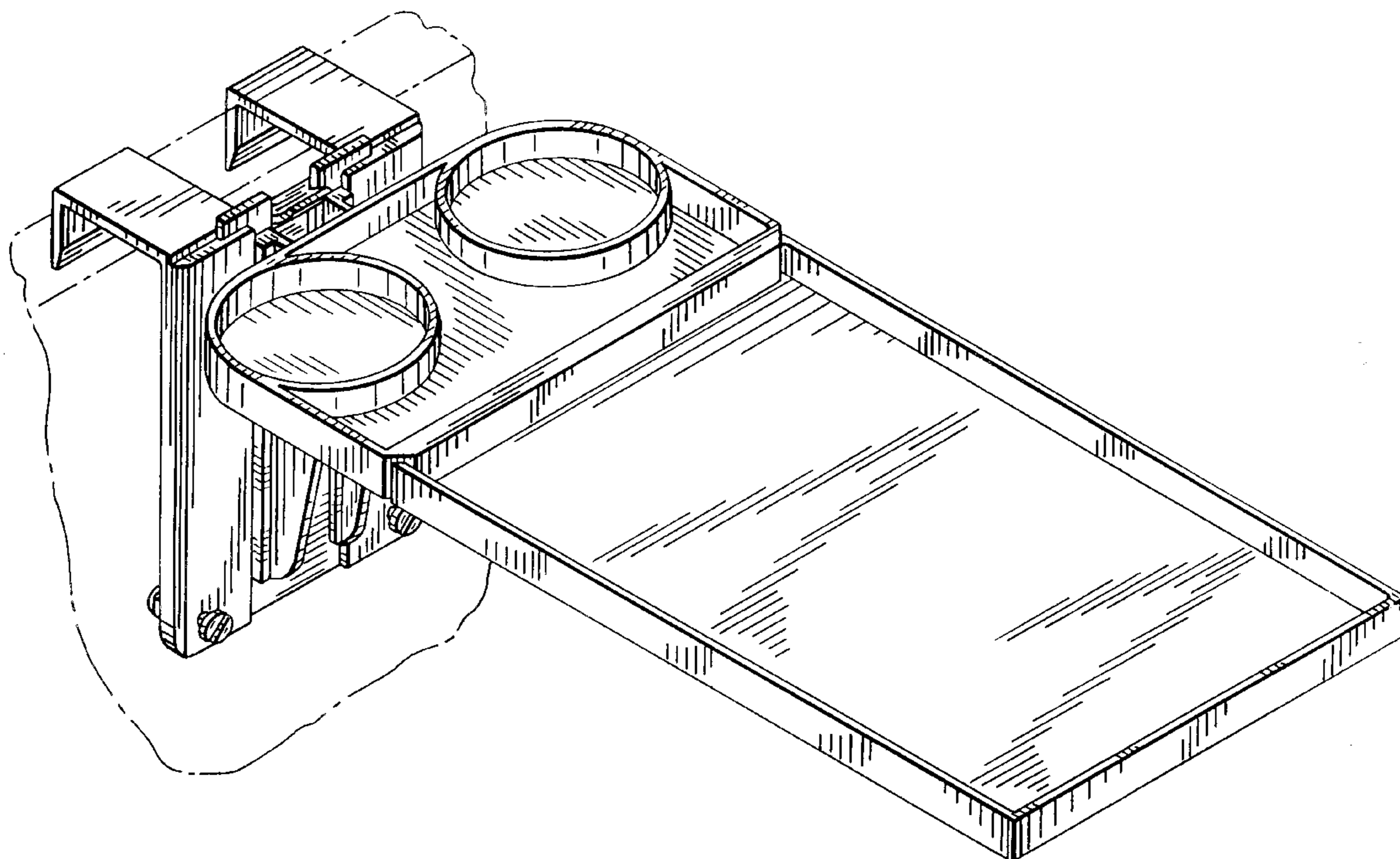

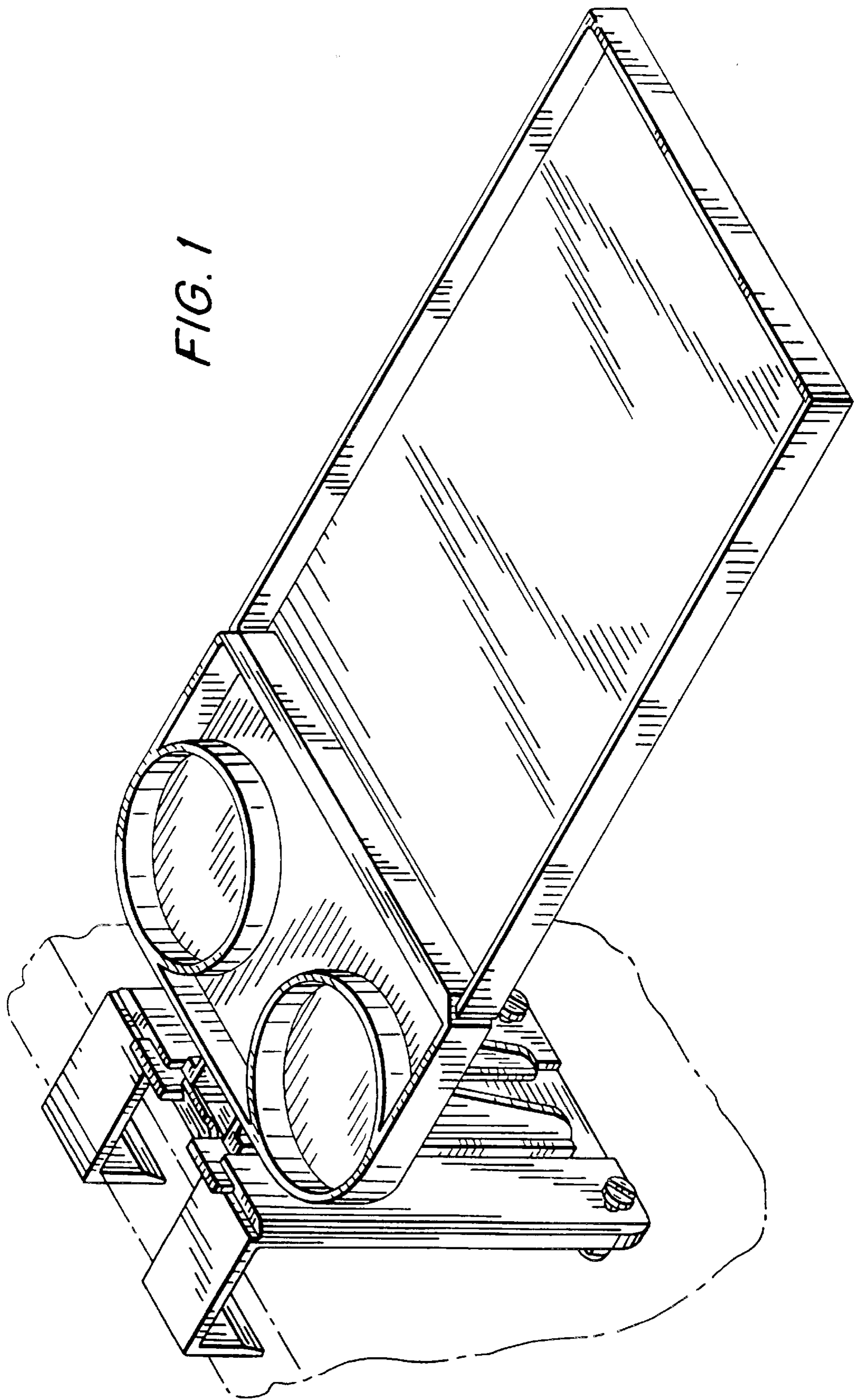

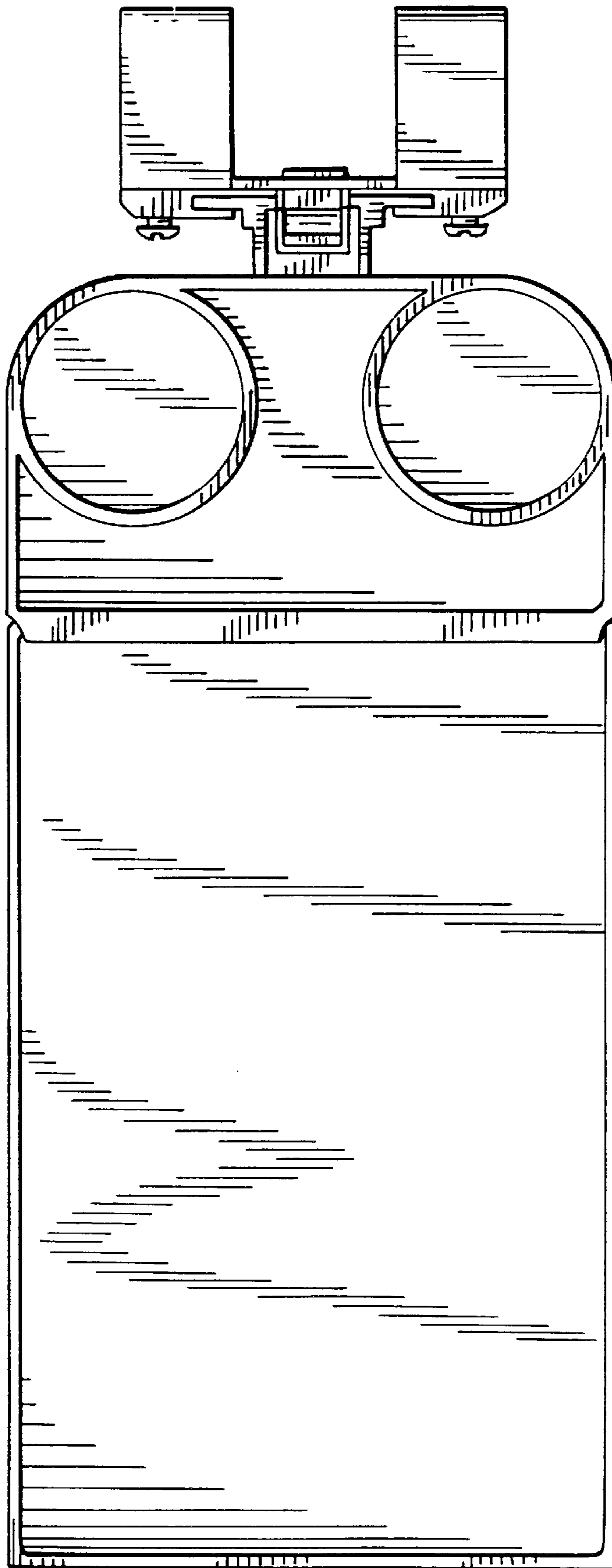

FIG. 2

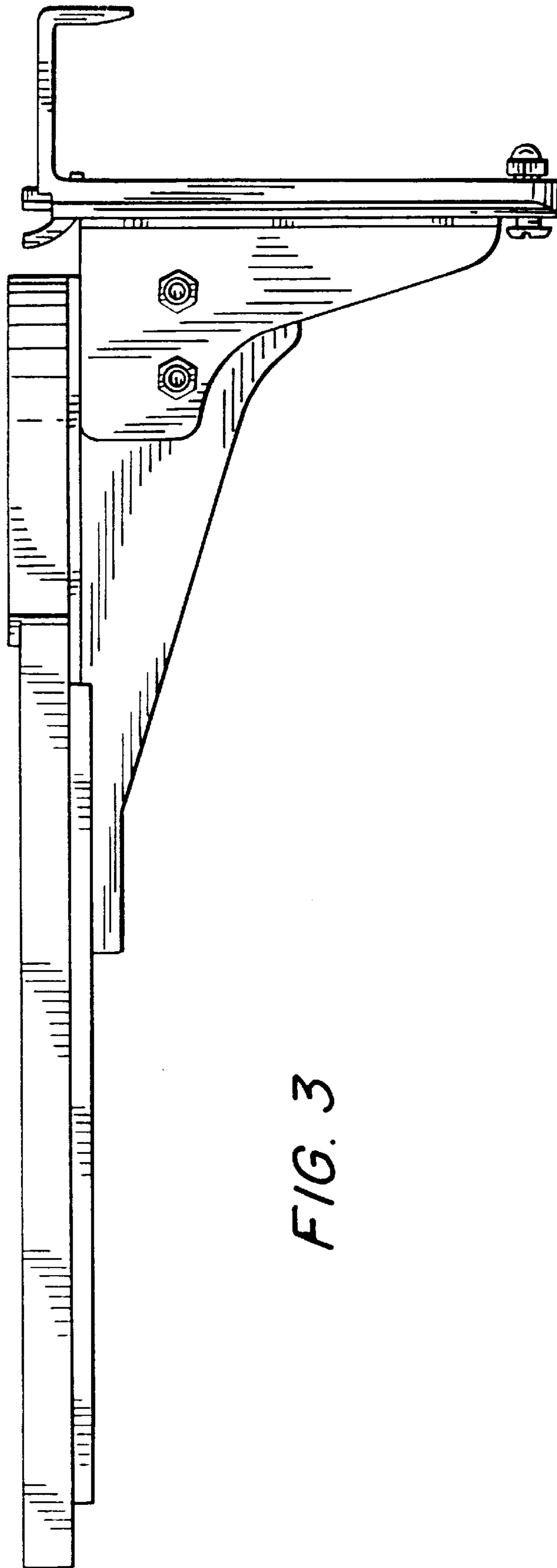

FIG. 3

FIG. 5

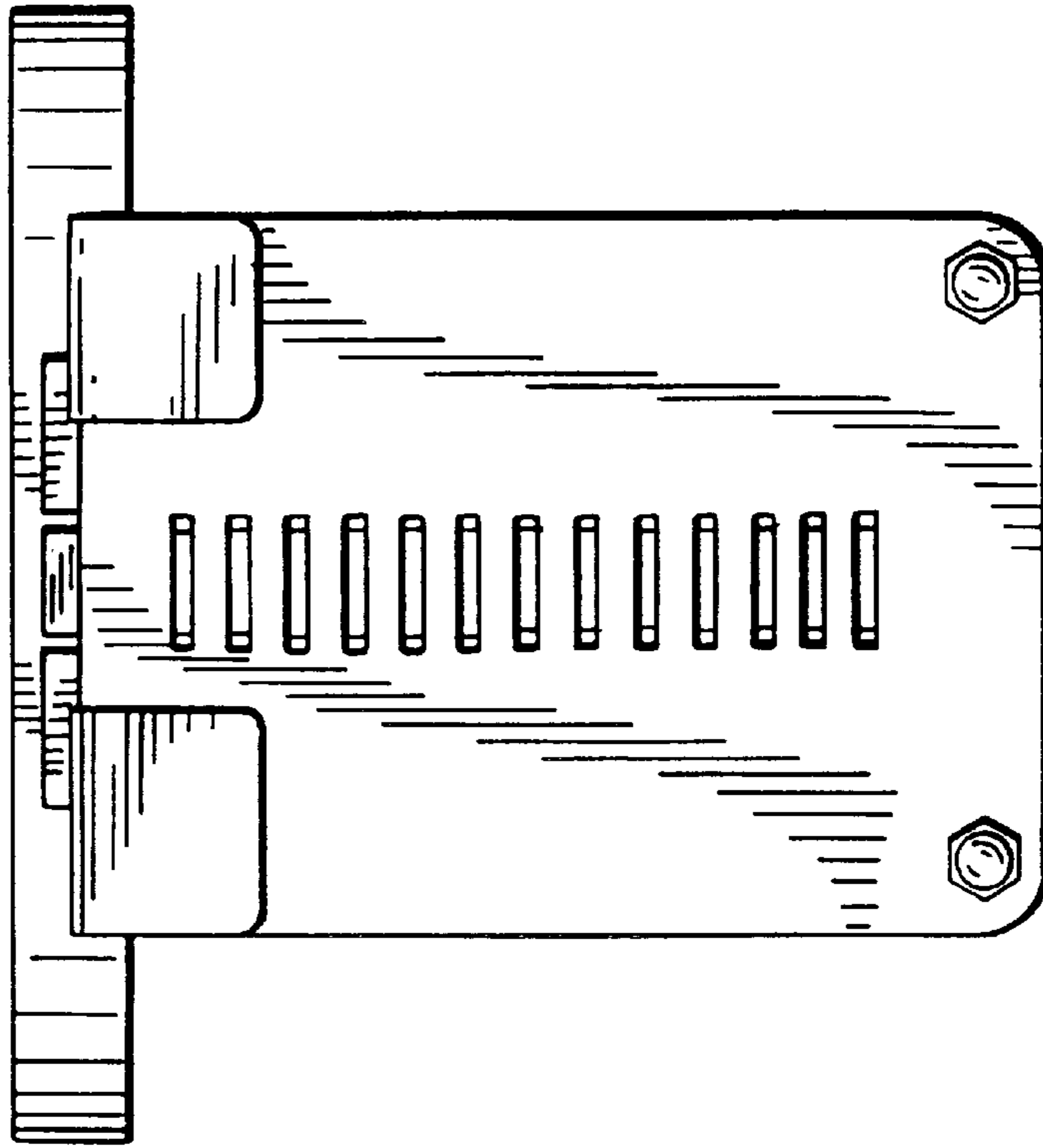
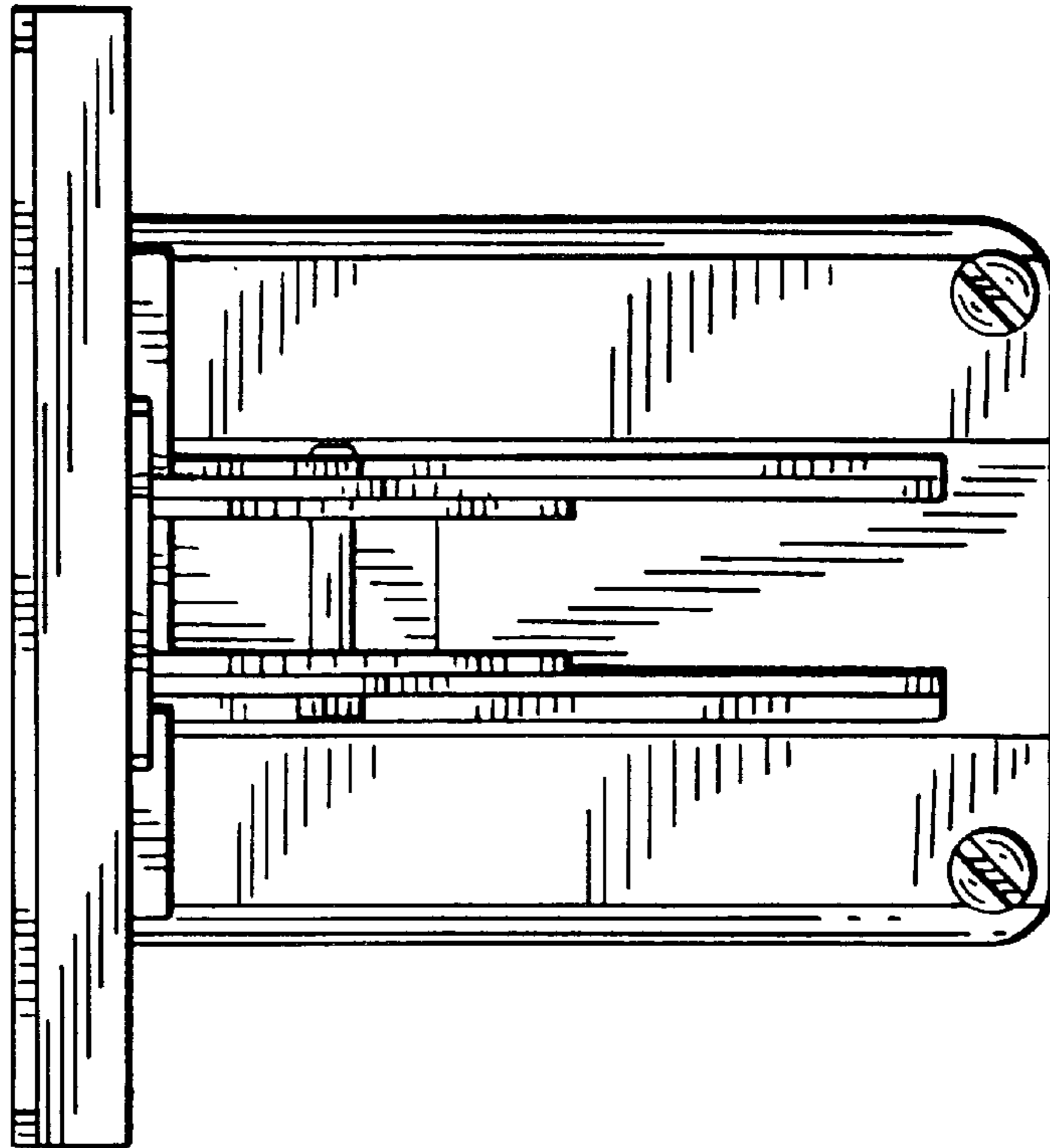

FIG. 4



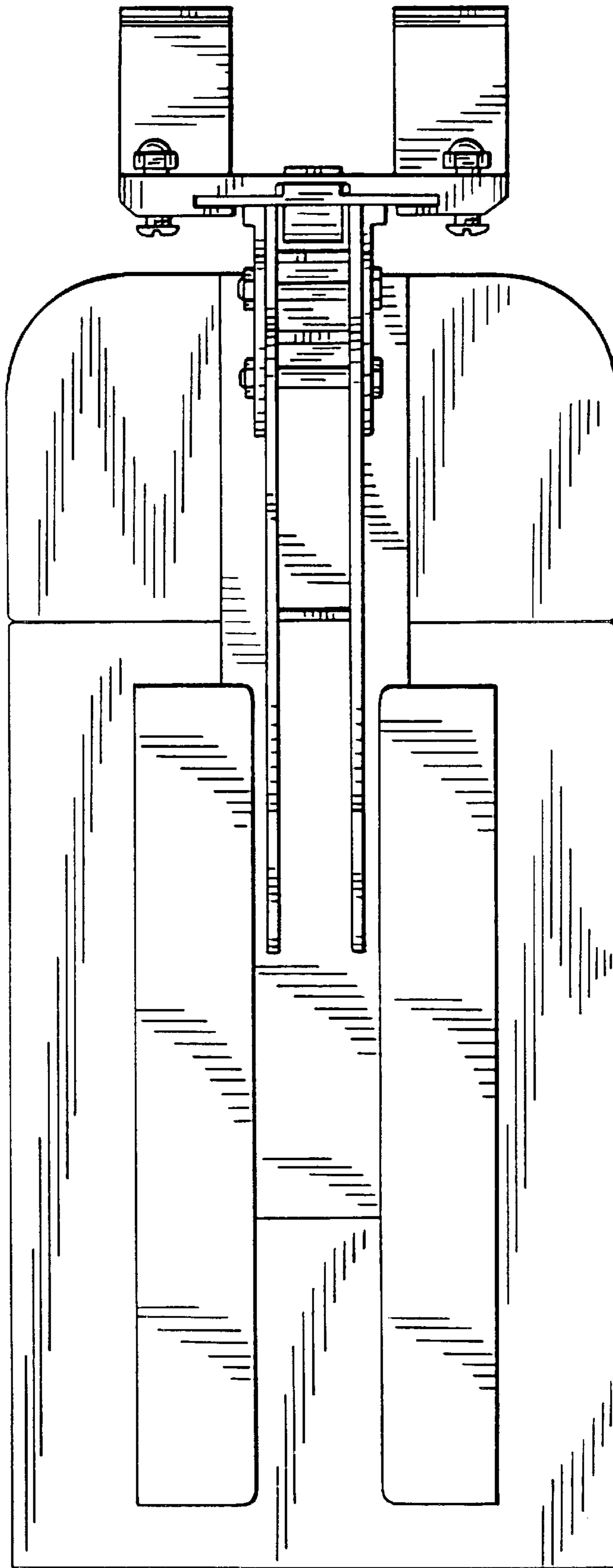

FIG. 6