



US00D415964S

United States Patent [19]
Manderfield, Jr. et al.

[11] **Patent Number: Des. 415,964**
[45] **Date of Patent: ** Nov. 2, 1999**

[54] **CONTAINER**

[75] Inventors: **Grover John Manderfield, Jr.**, Mount Prospect; **Tracy Lynn Beaver**, Carbondale, both of Ill.; **Robert D. Weick**, Sarasota, Fla.

[73] Assignee: **Tropicana Products, Inc.**, Bradenton, Fla.

[**] Term: **14 Years**

[21] Appl. No.: **29/078,875**

[22] Filed: **Oct. 31, 1997**

[51] **LOC (6) Cl.** **09-01**

[52] **U.S. Cl.** **D9/530; D9/543; D9/565; D9/569**

[58] **Field of Search** D9/552, 565, 562, D9/516, 530, 543, 571, 556, 569; 215/382, 383, 384

| | | | |
|------------|---------|-----------------------|--------|
| D. 366,417 | 1/1996 | Semersky . | |
| D. 366,831 | 2/1996 | Semersky et al. . | |
| D. 389,068 | 1/1998 | Hooker | D9/552 |
| 3,374,997 | 3/1968 | Stutenroth et al. . | |
| 4,313,545 | 2/1982 | Maeda . | |
| 4,538,439 | 9/1985 | Frei . | |
| 4,610,366 | 9/1986 | Estes et al. . | |
| 4,877,141 | 10/1989 | Hayashi et al. . | |
| 5,101,990 | 4/1992 | Krishnakumar et al. . | |
| 5,269,428 | 12/1993 | Gilbert . | |
| 5,350,078 | 9/1994 | Potts et al. . | |
| 5,392,937 | 2/1995 | Prevot et al. . | |
| 5,503,283 | 4/1996 | Semersky . | |
| 5,598,941 | 2/1997 | Semersky et al. . | |
| 5,622,579 | 4/1997 | Tobias . | |

Primary Examiner—Lucy Lieberman
Attorney, Agent, or Firm—Lockwood, Alex, Fitzgibbon & Cummings

[57] **CLAIM**

The ornamental design for a container, as shown and described.

[56] **References Cited**

U.S. PATENT DOCUMENTS

| | | | |
|------------|---------|-----------------|--------|
| D. 95,672 | 5/1935 | Fuerst | D9/562 |
| D. 101,984 | 11/1936 | Fuerst | D9/565 |
| D. 115,155 | 6/1939 | D'Addario . | |
| D. 144,500 | 4/1946 | Frederics | D9/565 |
| D. 191,598 | 10/1961 | Lonker | D9/556 |
| D. 196,752 | 10/1963 | Koenigsberg . | |
| D. 286,021 | 10/1986 | O'Reilly | D9/565 |
| D. 308,484 | 6/1990 | Browton . | |
| D. 344,457 | 2/1994 | Prevot et al. . | |
| D. 345,506 | 3/1994 | Potts et al. . | |
| D. 354,000 | 1/1995 | Hoyt . | |
| D. 366,416 | 1/1996 | Semersky . | |

DESCRIPTION

FIG. 1 is a perspective view of a container showing the new design;
FIG. 2 is a front elevational view thereof;
FIG. 3 is a rear elevational view thereof;
FIG. 4 is a left side elevational view thereof;
FIG. 5 is a right side elevational view thereof;
FIG. 6 is a top plan view thereof; and,
FIG. 7 is a bottom plan view thereof.
The broken lines in the drawings are for illustrative purposes only and do not form part of the claimed design.

1 Claim, 5 Drawing Sheets

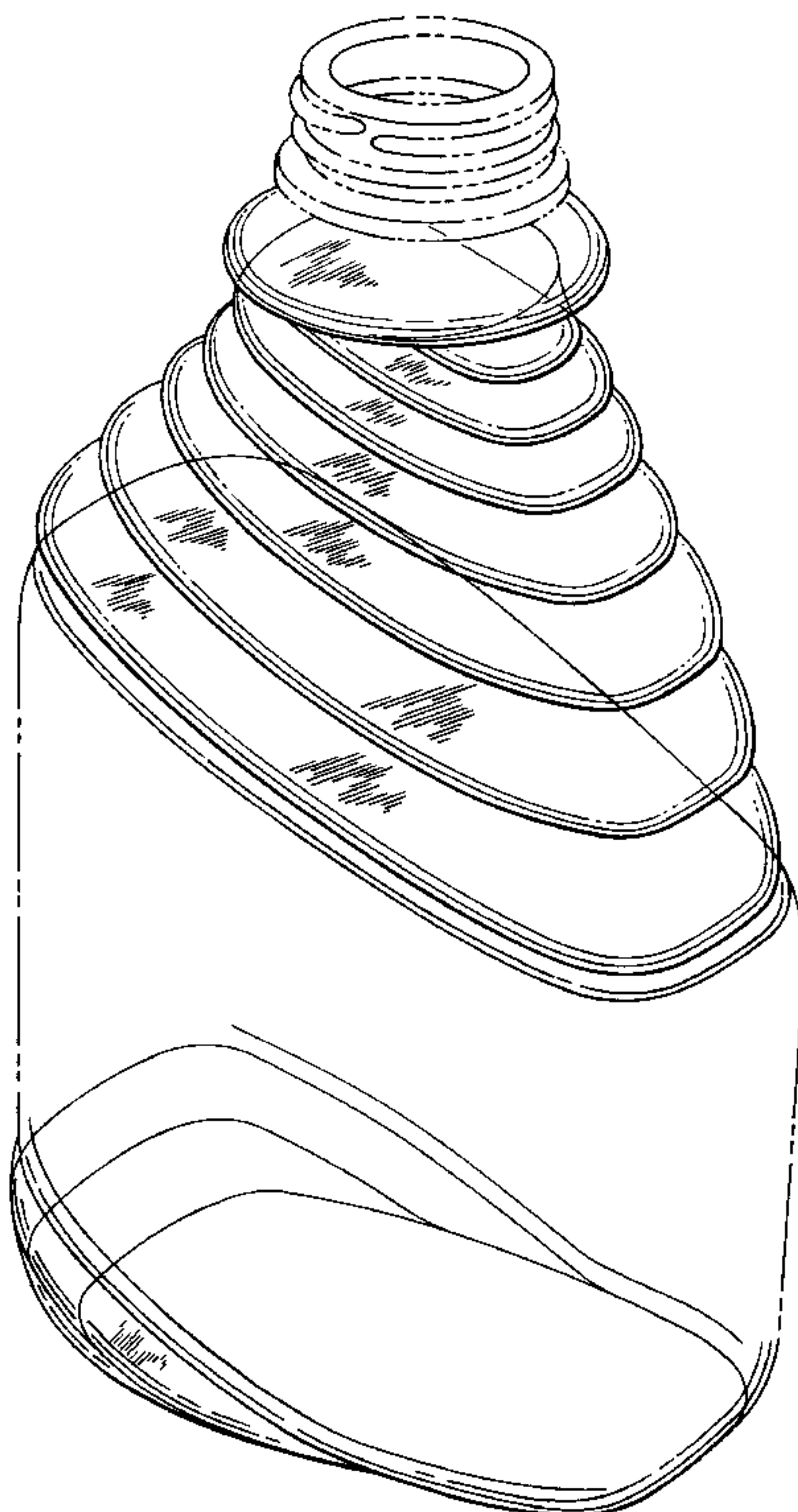

FIG. 1

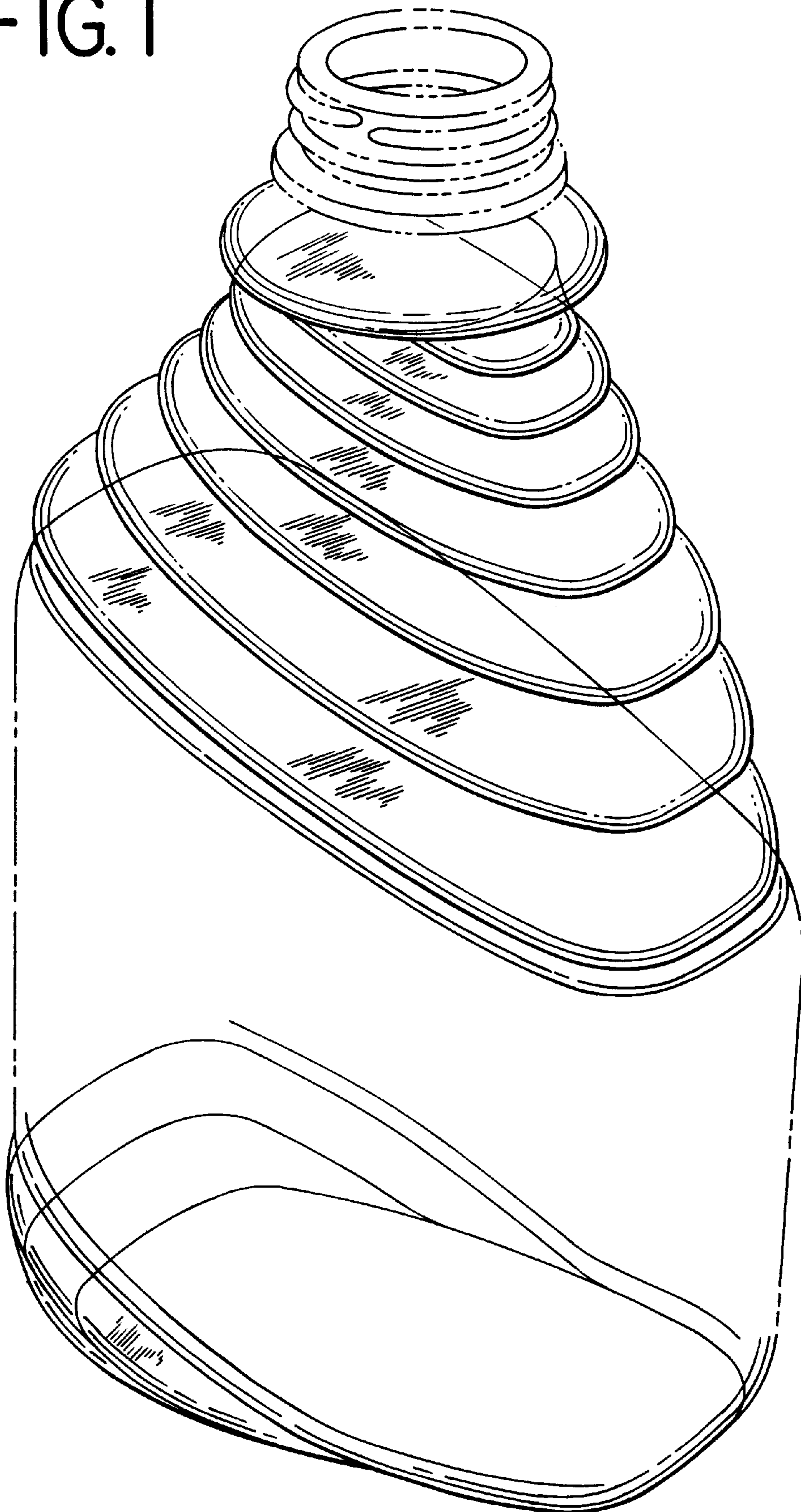

FIG. 2

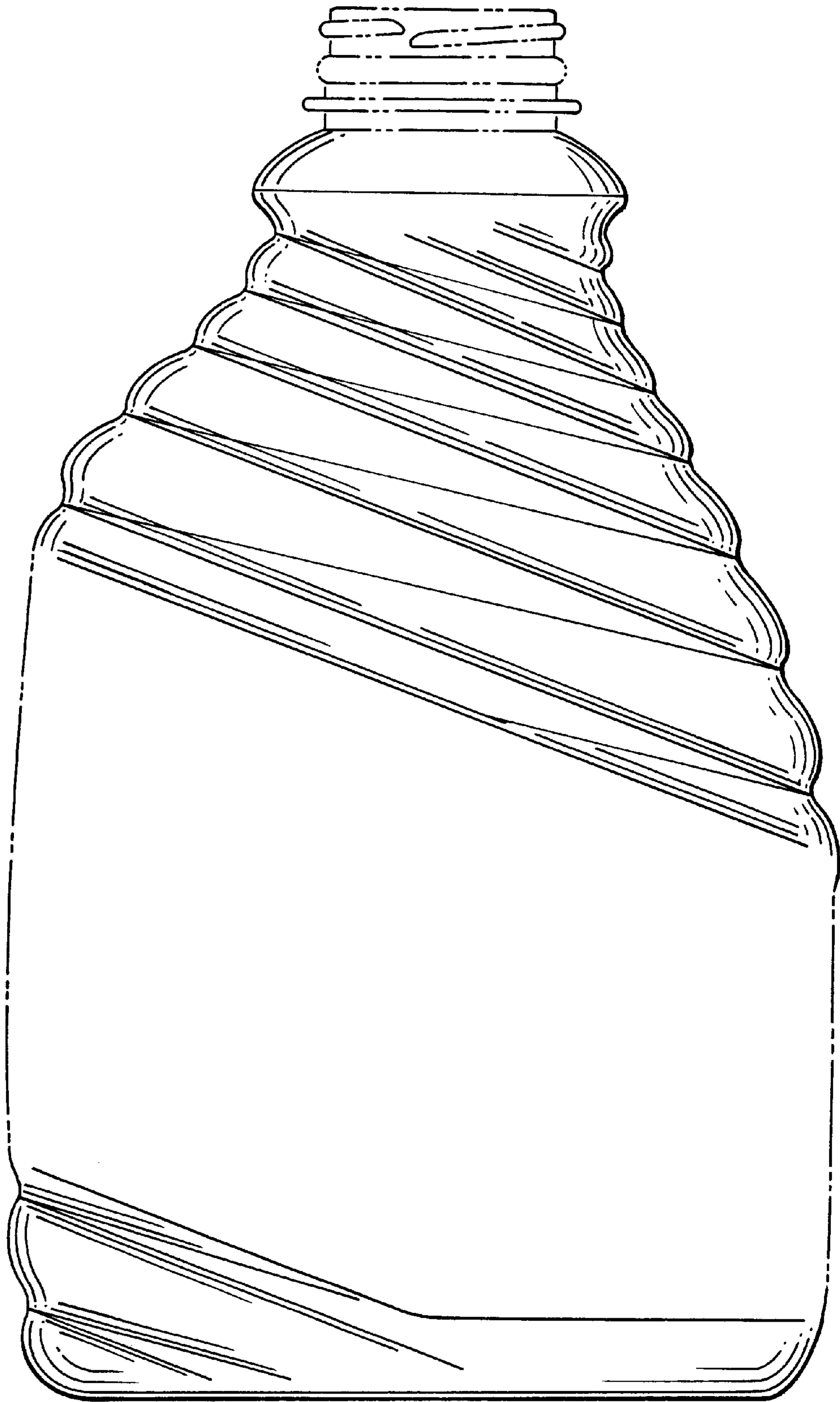

FIG. 3

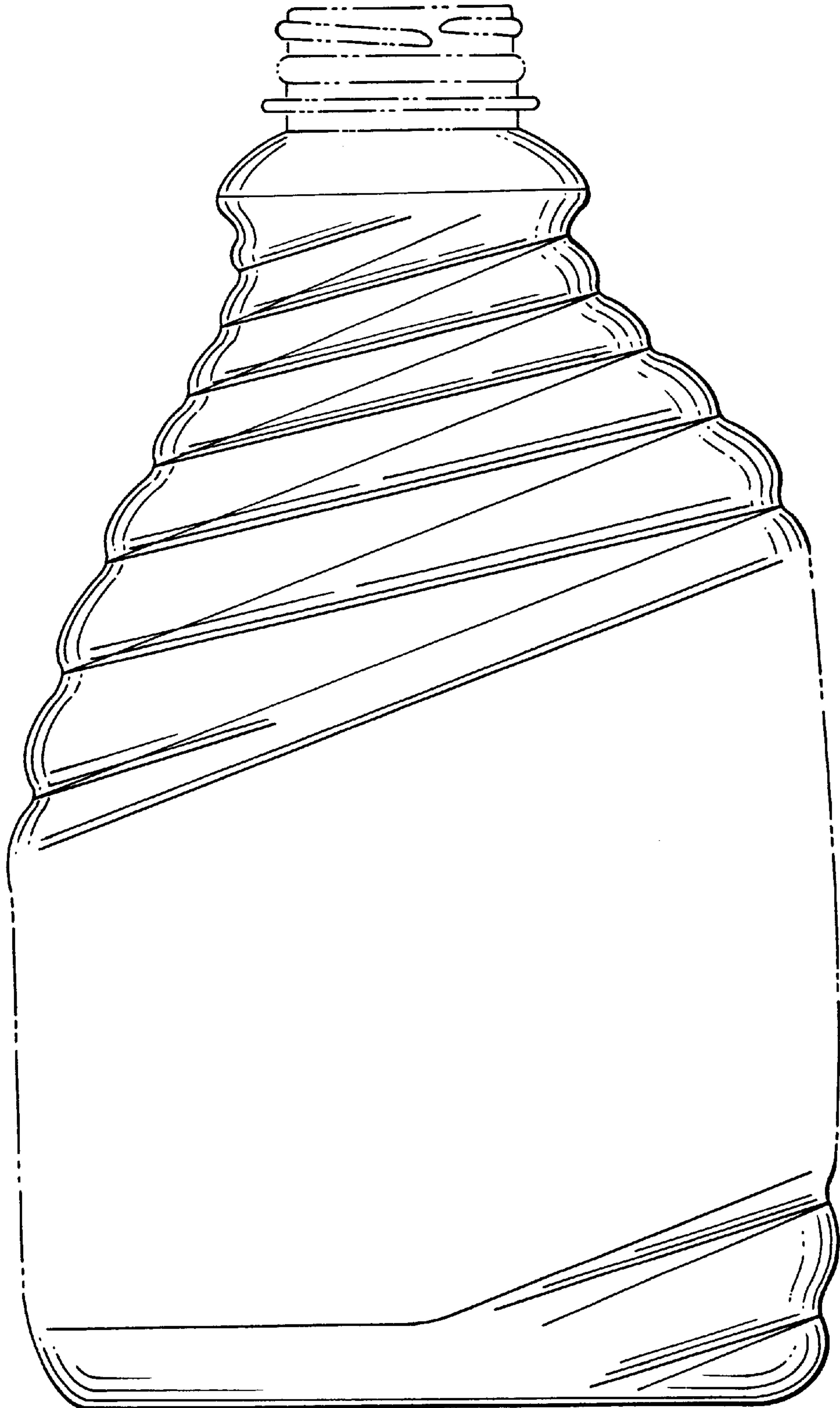

FIG. 4

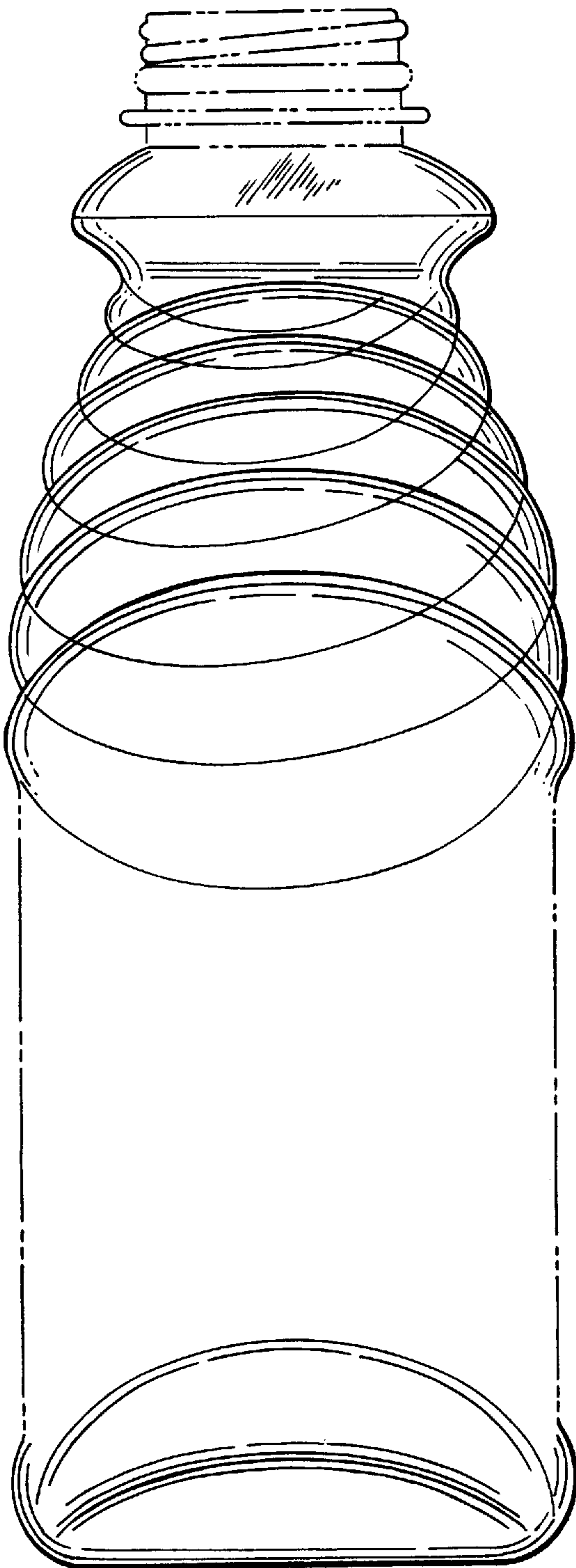

FIG. 5

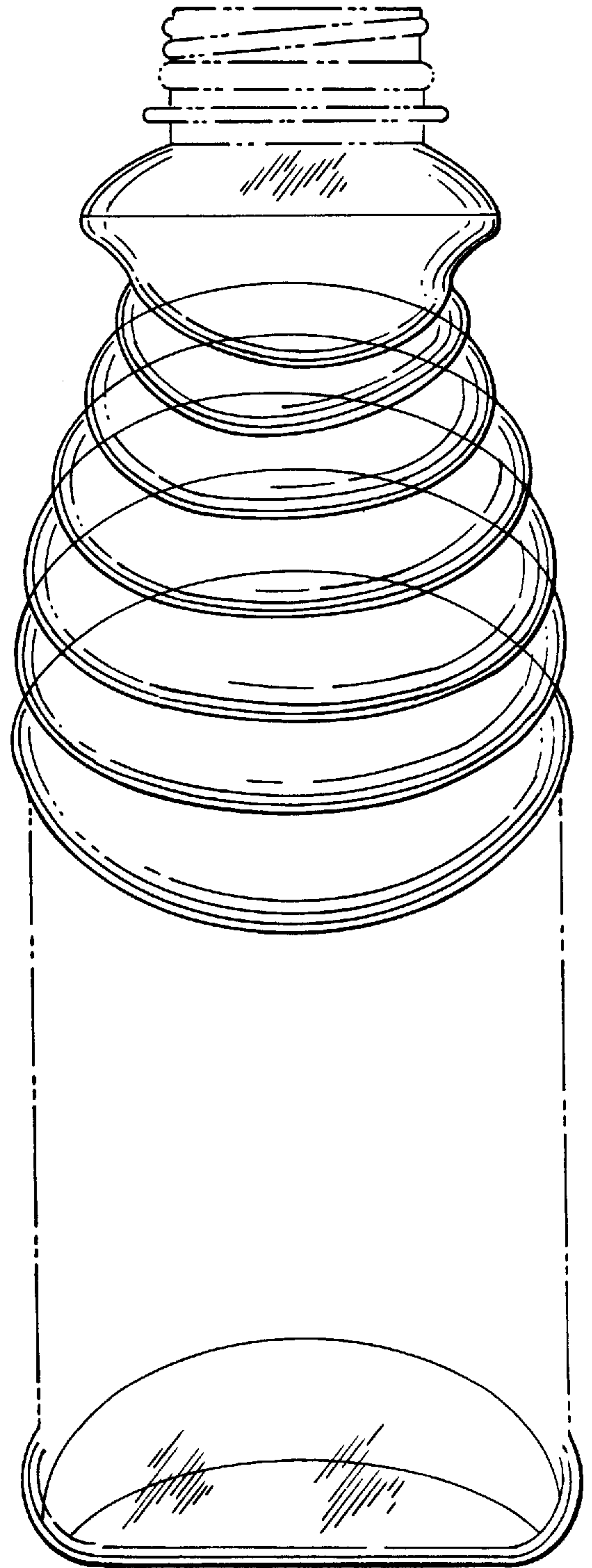

FIG. 6

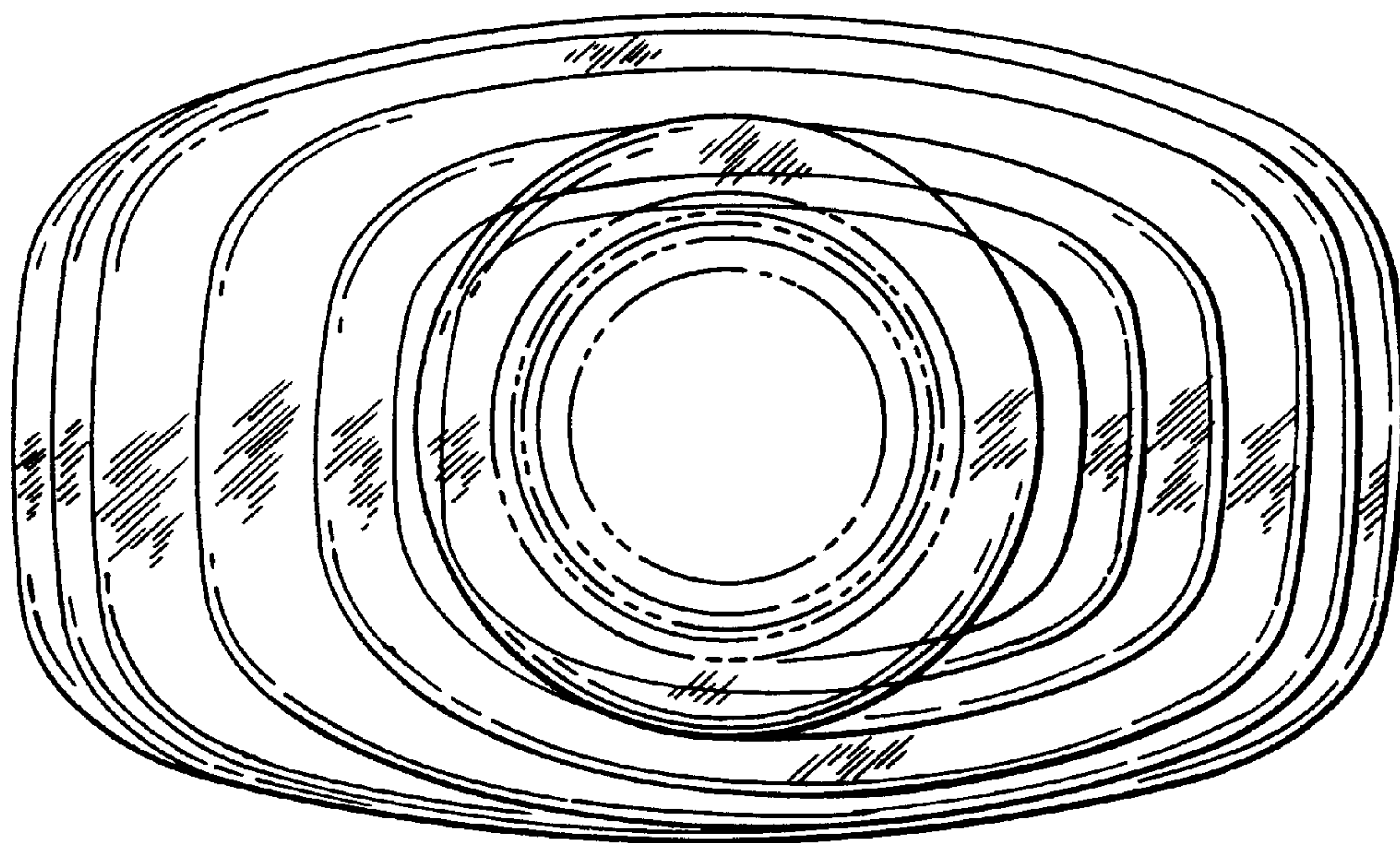

FIG. 7

