



US00D415937S

United States Patent [19] Robinson

[11] Patent Number: **Des. 415,937**
[45] Date of Patent: **** Nov. 2, 1999**

[54] **ONION BLOSSOM MAKER**
[75] Inventor: **Glenn Robinson**, Monmouth Junction, N.J.
[73] Assignee: **Telebrands Corp.**, Fairfield, N.J.
[**] Term: **14 Years**
[21] Appl. No.: **29/092,538**
[22] Filed: **Aug. 21, 1998**
[51] **LOC (6) Cl.** **07-04**
[52] **U.S. Cl.** **D7/673**
[58] **Field of Search** D7/672, 673; 30/114, 30/115; 83/404.3, 435.15, 662, 856-858; 99/430, 538, 509, 537

3,830,151 8/1974 Gerson 99/537
4,095,518 6/1978 Jones 99/538
4,111,112 9/1978 Altman 99/538
4,310,969 1/1982 Cannizzaro et al. 30/113.1
4,436,025 3/1984 Jones 99/538
4,559,856 12/1985 Pettus 83/431
4,569,280 2/1986 D'Ambro 99/538
4,596,073 6/1986 Ewald 30/113.1
4,653,393 3/1987 Ross 99/542
5,101,718 4/1992 Lin 99/545
5,142,973 9/1992 Tur et al. 99/538
5,337,480 8/1994 Codikow 30/114
5,363,756 11/1994 Muro 99/538
5,699,725 12/1997 Poltielov 99/494

[56] **References Cited**

U.S. PATENT DOCUMENTS

206,967 8/1878 Pfeifer et al. .
D. 298,790 12/1988 Hutchinson .
D. 365,612 12/1995 Pravitz D21/198
703,331 6/1902 Acree .
867,970 10/1907 Hedborg .
951,241 3/1910 Hampel .
1,040,582 10/1912 Royer et al. .
1,339,950 5/1920 Fowler .
1,825,628 9/1931 Floyd et al. .
1,825,629 9/1931 Floyd .
1,943,113 1/1934 Daum 146/160
2,329,918 9/1943 Leavens 146/160
2,383,814 8/1945 Richardson 30/302
2,479,982 8/1949 Stevens 146/169
2,540,014 1/1951 Smith 146/3
2,560,229 7/1951 Leavens 146/3
2,625,972 1/1953 Torres 146/159
2,645,262 7/1953 Marasco 146/3
2,647,549 8/1953 Koch 146/3
2,836,212 5/1958 Shaw 146/160
2,852,053 10/1958 Berry et al. 146/169
2,990,615 7/1961 Ohler 30/316
3,016,608 1/1962 Myers 30/114
3,060,838 10/1962 Priore 99/430
3,128,810 4/1964 Whipp 146/40
3,468,355 9/1969 Hall 146/78
3,696,847 10/1972 Erekson et al. 146/42
3,807,266 4/1974 Camp 83/404.4

FOREIGN PATENT DOCUMENTS

52415 6/1890 Germany .
817351 10/1951 Germany 99/545
2302331 7/1974 Germany 99/537
2807739 5/1980 Germany .
21823 7/1965 Japan .
146222 7/1931 Switzerland .
379705 7/1964 Switzerland 99/537
379926 9/1932 United Kingdom .

OTHER PUBLICATIONS

Lincoln Foodservice Products, Inc. advertisement for "Onion Bloomer" (Oct. 1992).

Primary Examiner—Terry A. Wallace
Attorney, Agent, or Firm—Cooper & Dunham LLP

[57] **CLAIM**

The ornamental design for an onion blossom maker, as shown and described.

DESCRIPTION

FIG. 1 is an exploded perspective view of a first embodiment of an onion blossom maker in accordance with my ornamental design;
FIG. 2 is a front view of the base of the onion blossom maker of FIG. 1, the rear view being substantially identical;
FIG. 3 is a top view of the base of the onion blossom maker of FIG. 1;
FIG. 4 is a side view of a representative side of the base of the onion blossom maker of FIG. 1;
FIG. 5 is a bottom view of the base of the onion blossom maker of FIG. 1;

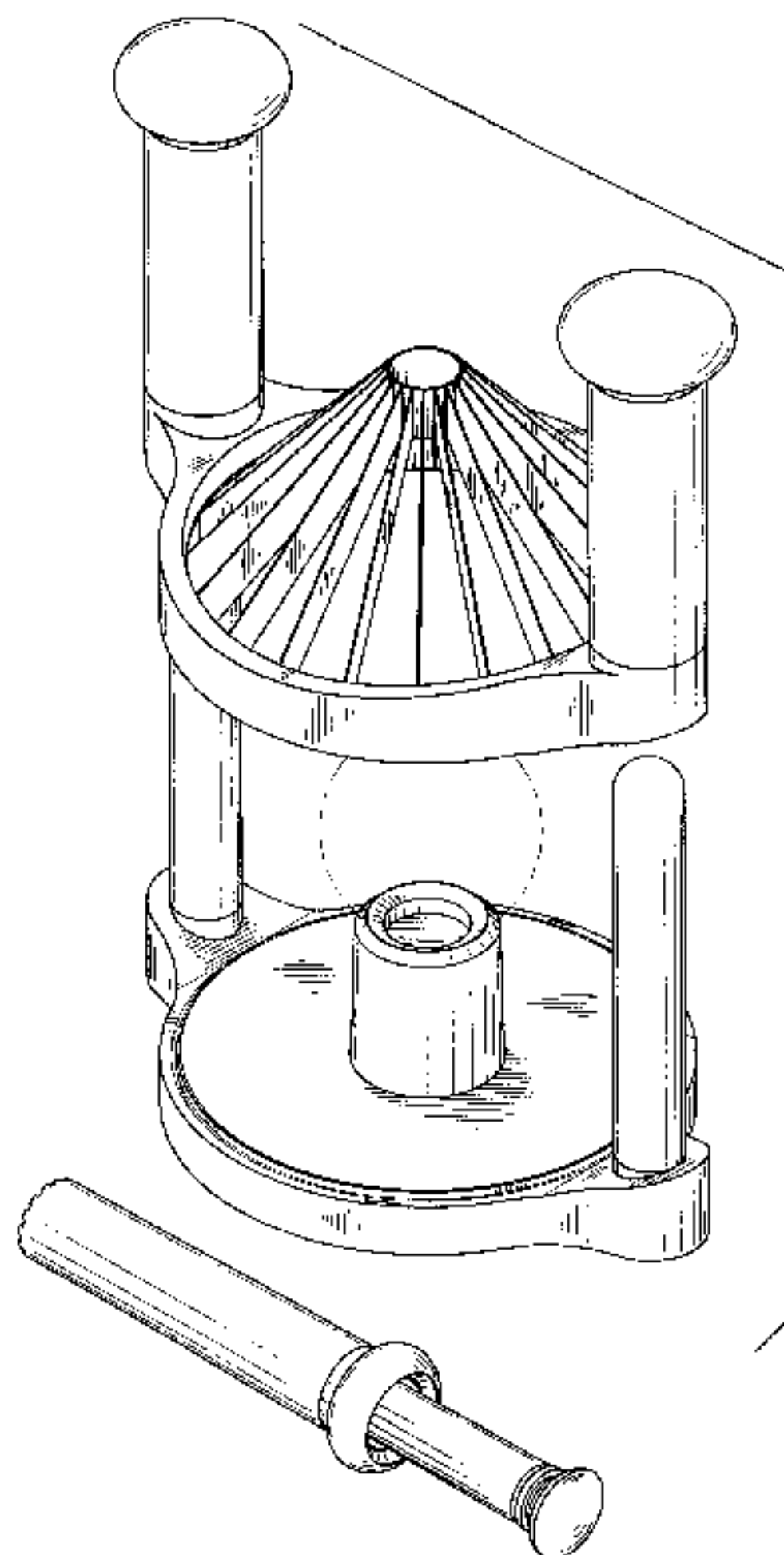

FIG. 6 is a front view of the cutter of the onion blossom maker of FIG. 1, the rear view being substantially identical; FIG. 7 is a side view of a representative side of the cutter of the onion blossom maker of FIG. 1;

FIG. 8 is a top view of the cutter of the onion blossom maker of FIG. 1;

FIG. 9 is a bottom view of the cutter of the onion blossom maker of FIG. 1;

FIG. 10 is a perspective view of the corer/plunger assembly of the onion blossom maker of FIG. 1;

FIG. 11 is a front view of the plunger of the corer/plunger assembly of the onion blossom maker of FIG. 1, the rear view being substantially identical;

FIG. 12 is a top view of the plunger of the corer/plunger assembly of the onion blossom maker of FIG. 1;

FIG. 13 is a bottom view of the plunger of the corer/plunger assembly of the onion blossom maker of FIG. 1;

FIG. 14 is a front view of the corer of the corer/plunger assembly of the onion blossom maker of FIG. 1, the rear view being substantially identical;

FIG. 15 is a top view of the corer of the corer/plunger assembly of the onion blossom maker of FIG. 1; and,

FIG. 16 is a bottom view of the corer of the corer/plunger assembly of the onion blossom maker of FIG. 1.

The broken lines in FIG. 1 are for illustrative purposes only and form no part of the claimed design.

The base, cutter, corer/plunger, corer and plunger are shown separately for clarity of illustration.

1 Claim, 7 Drawing Sheets

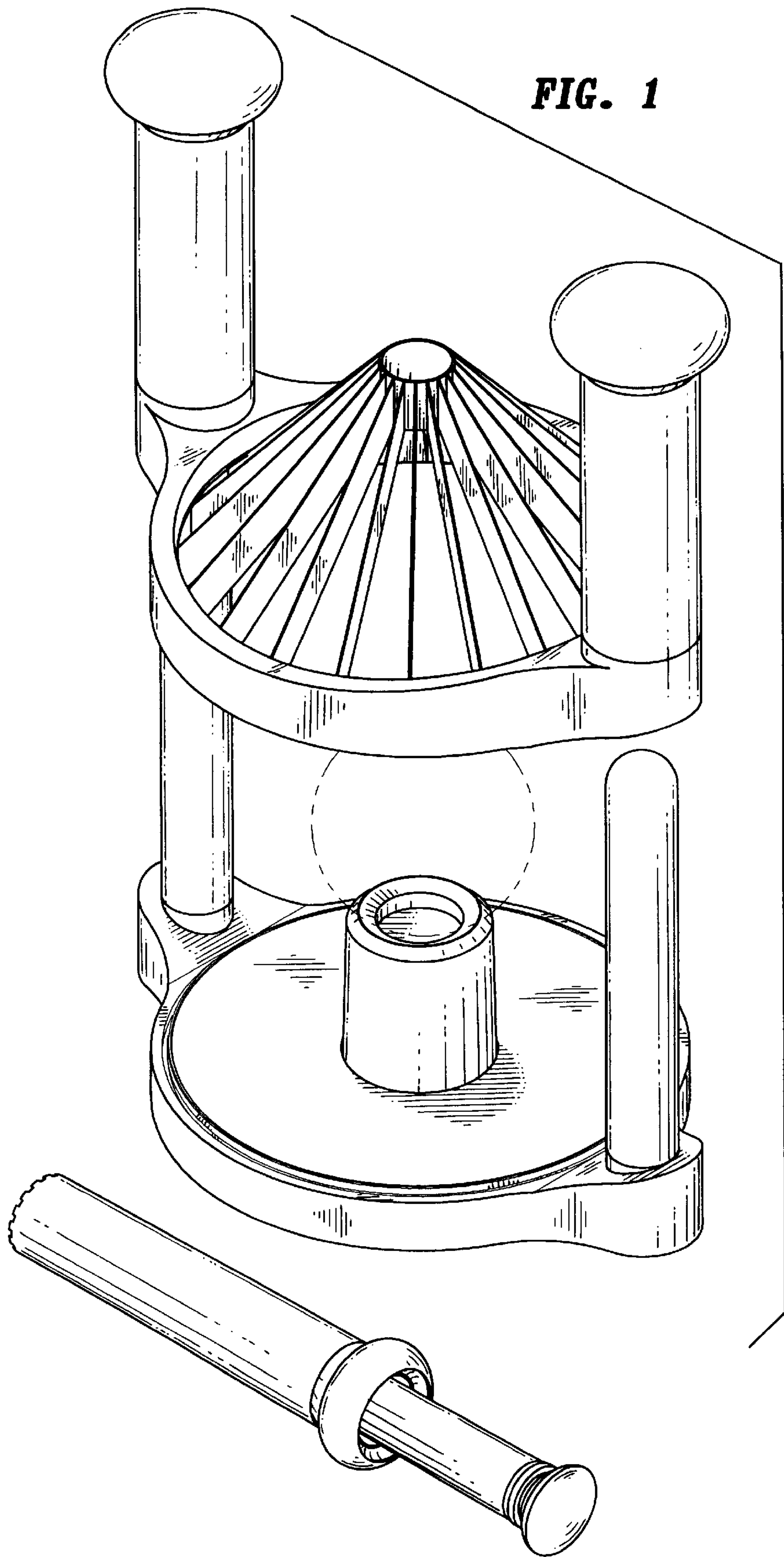

FIG. 2

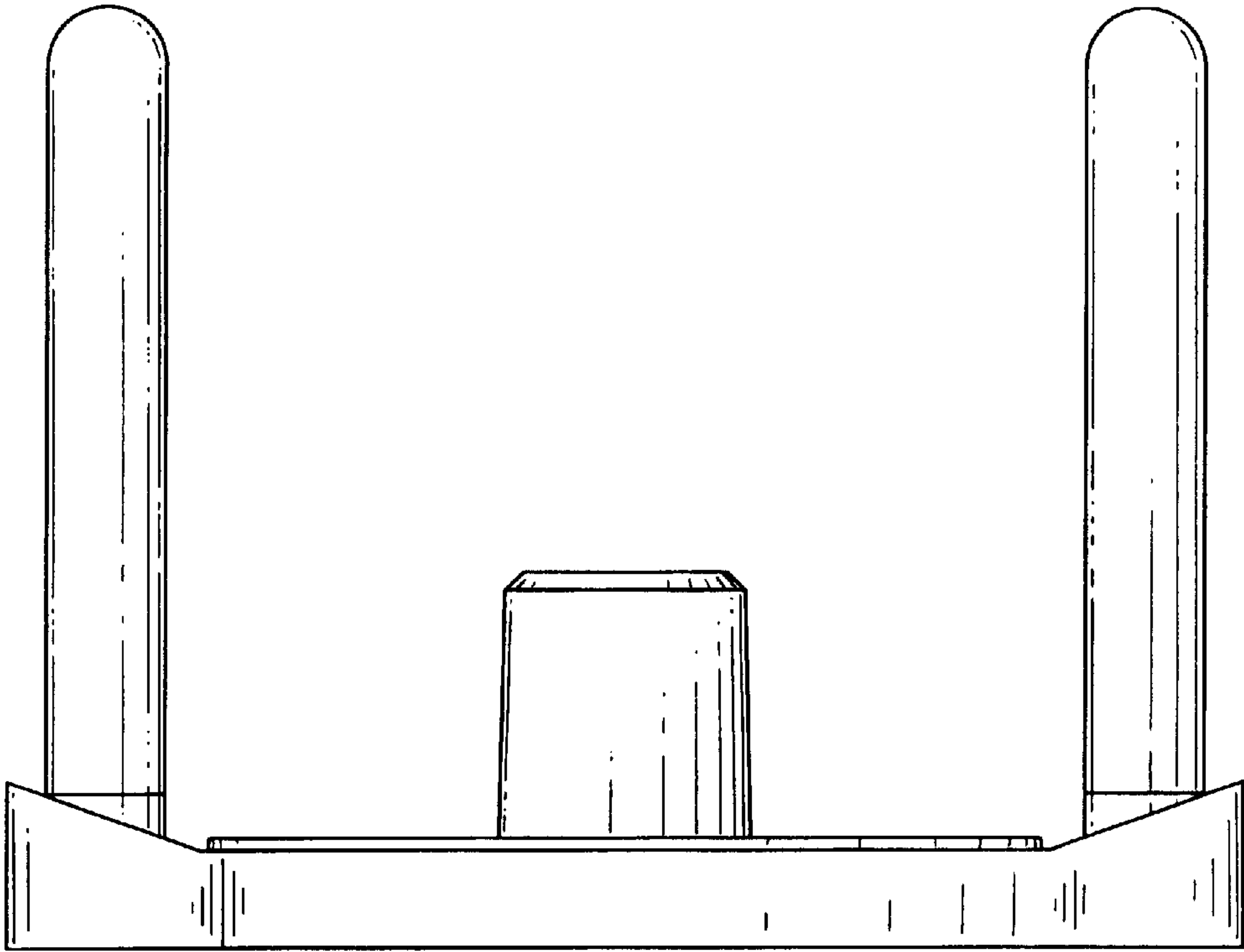

FIG. 3

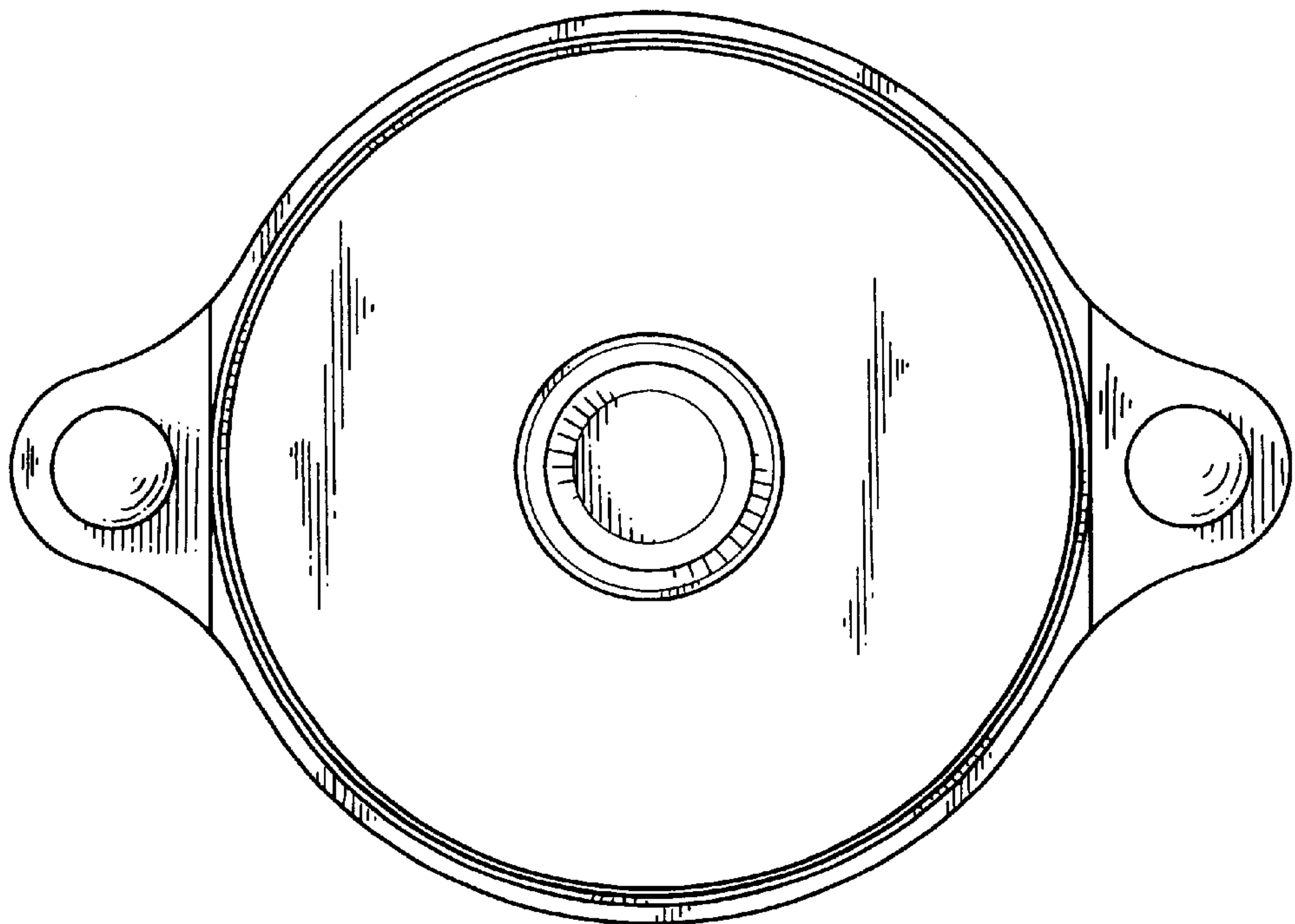

FIG. 4

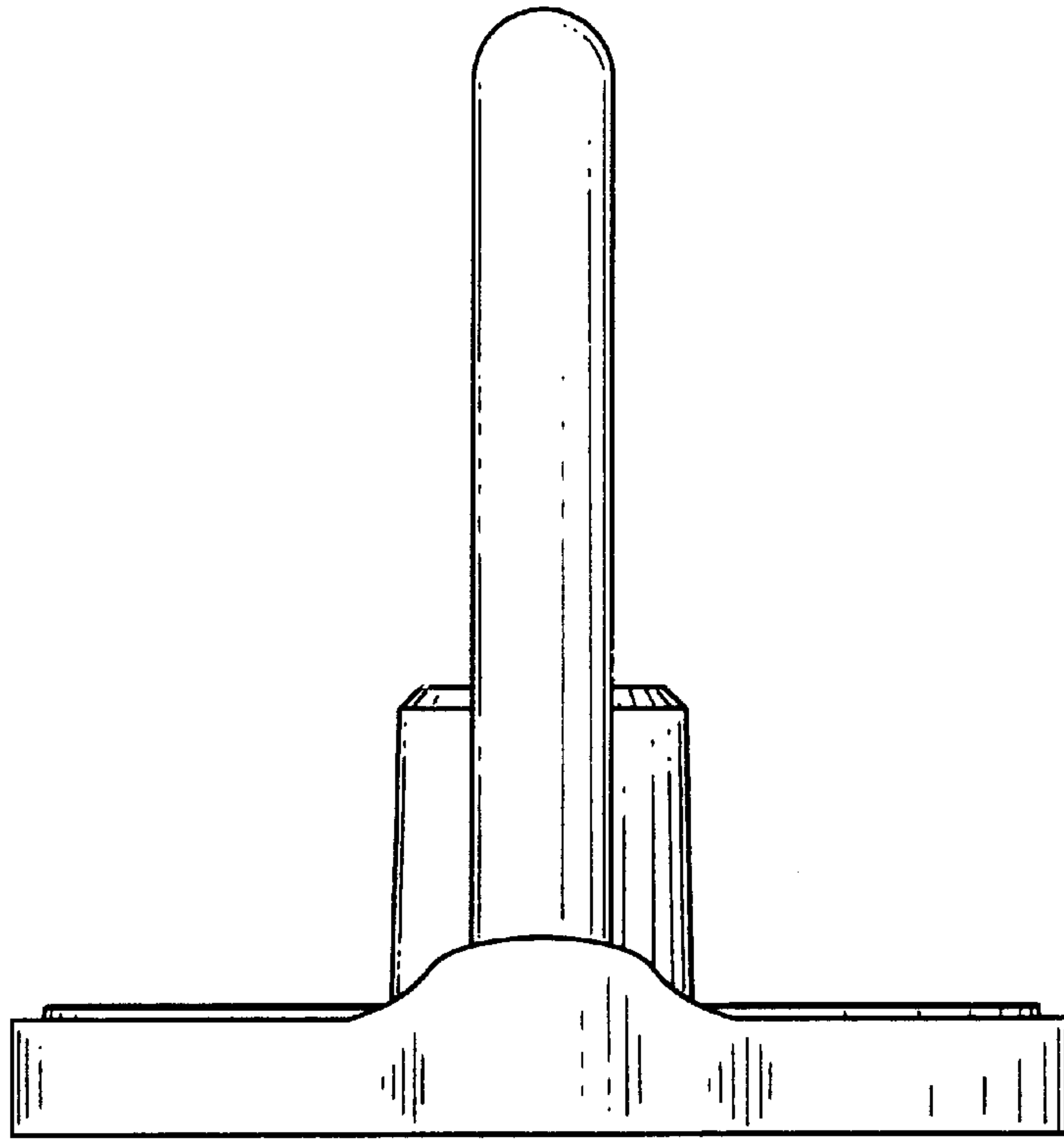

FIG. 5

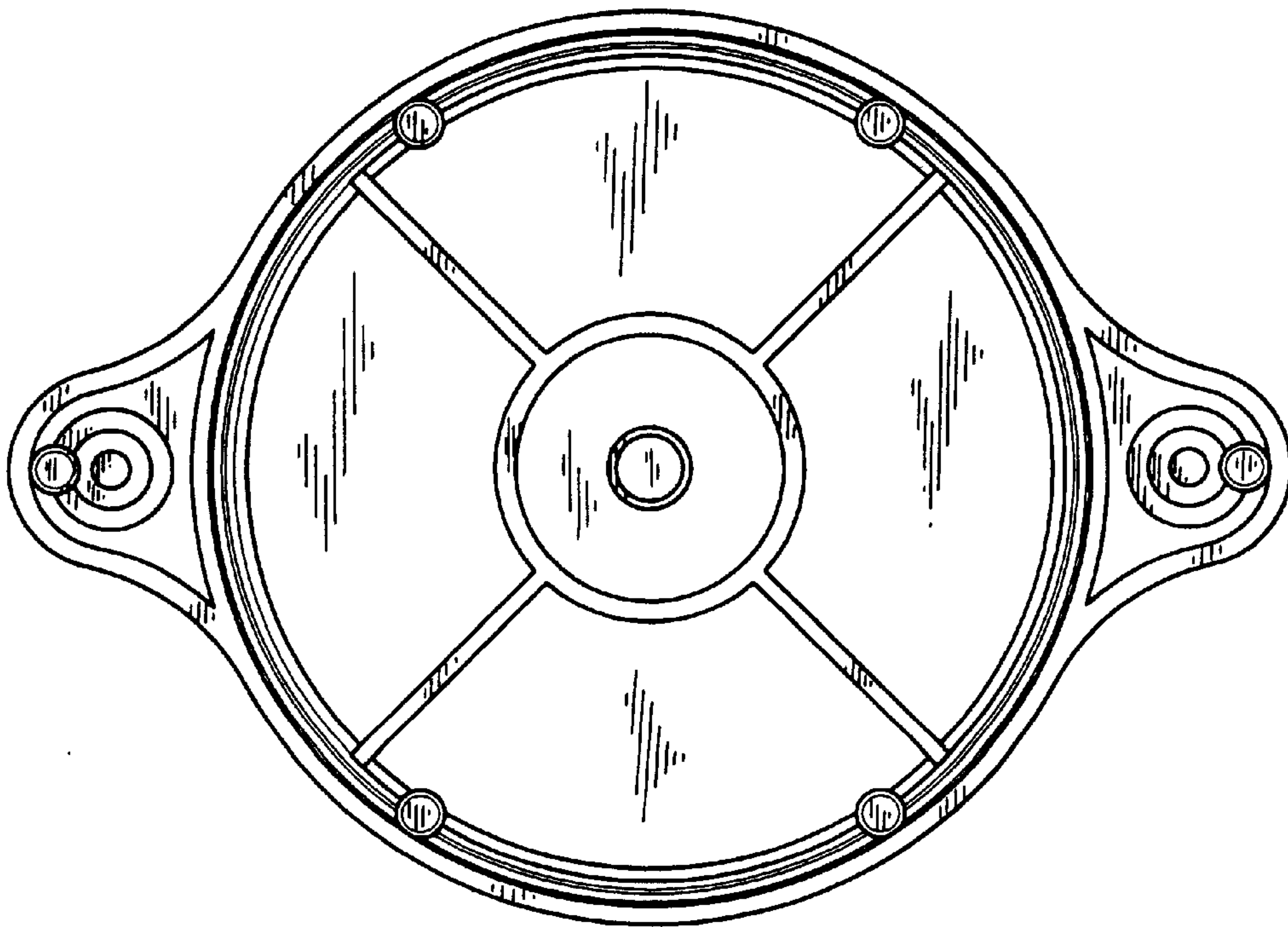

FIG. 6

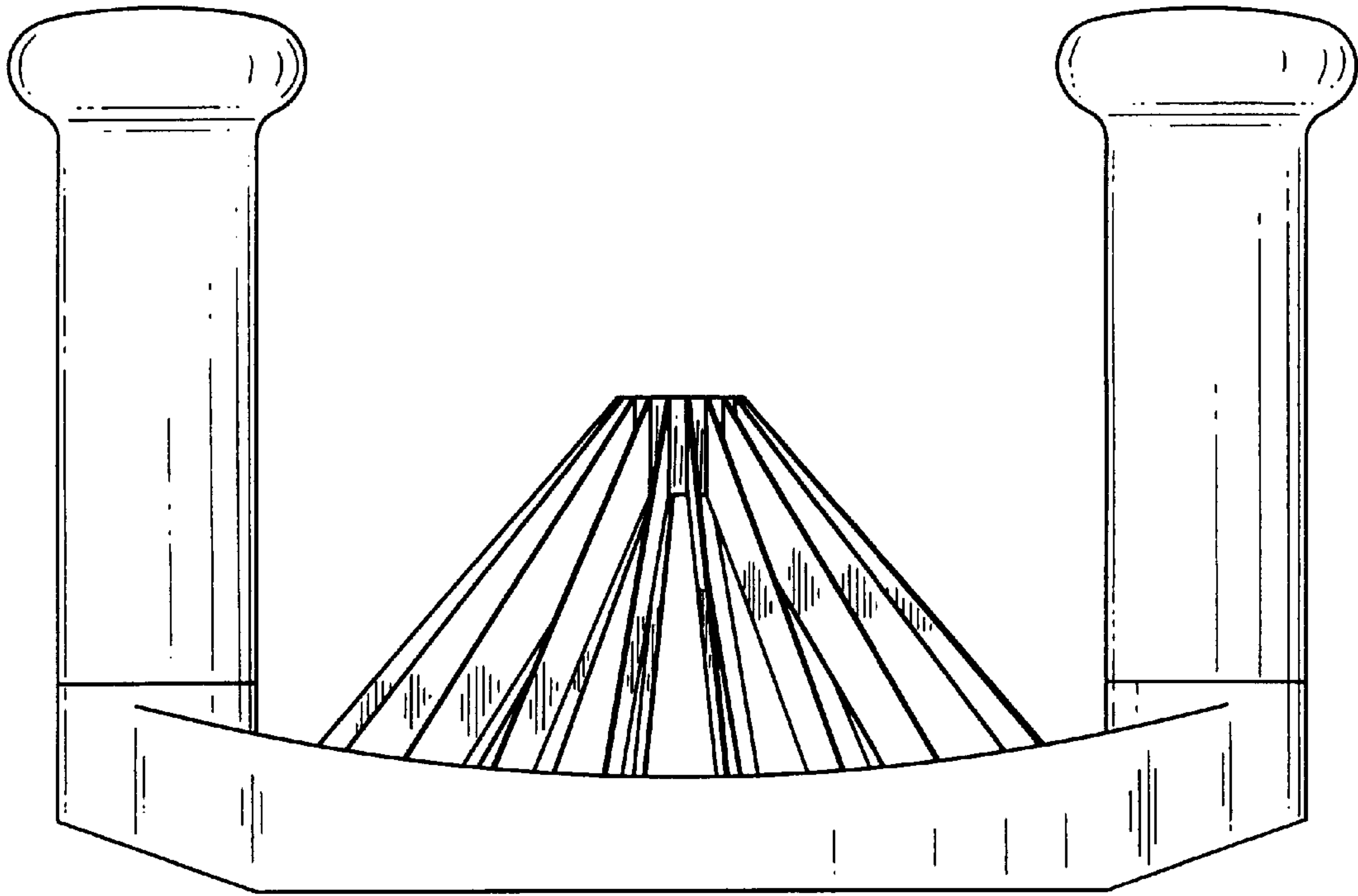

FIG. 7

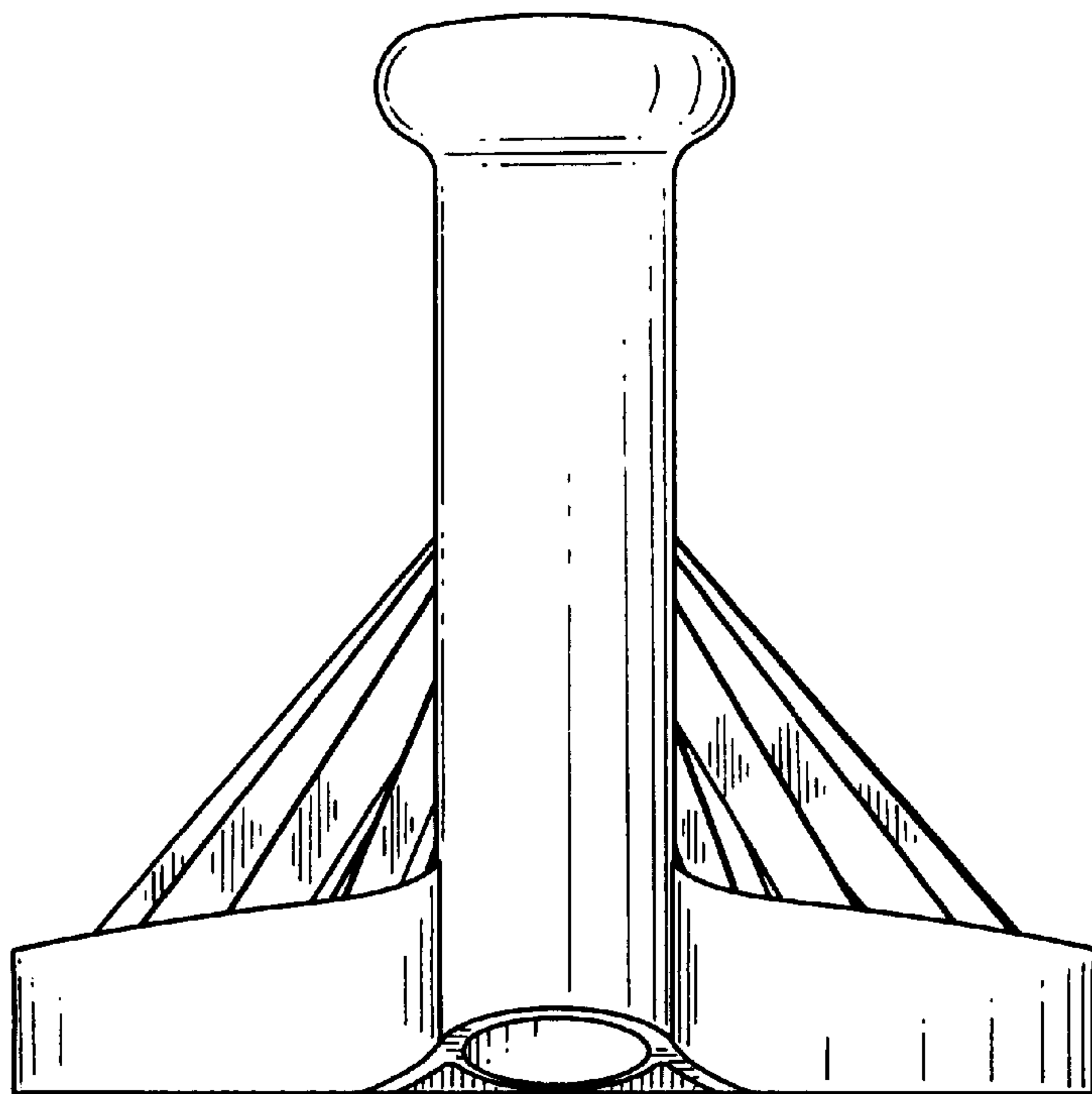

FIG. 8

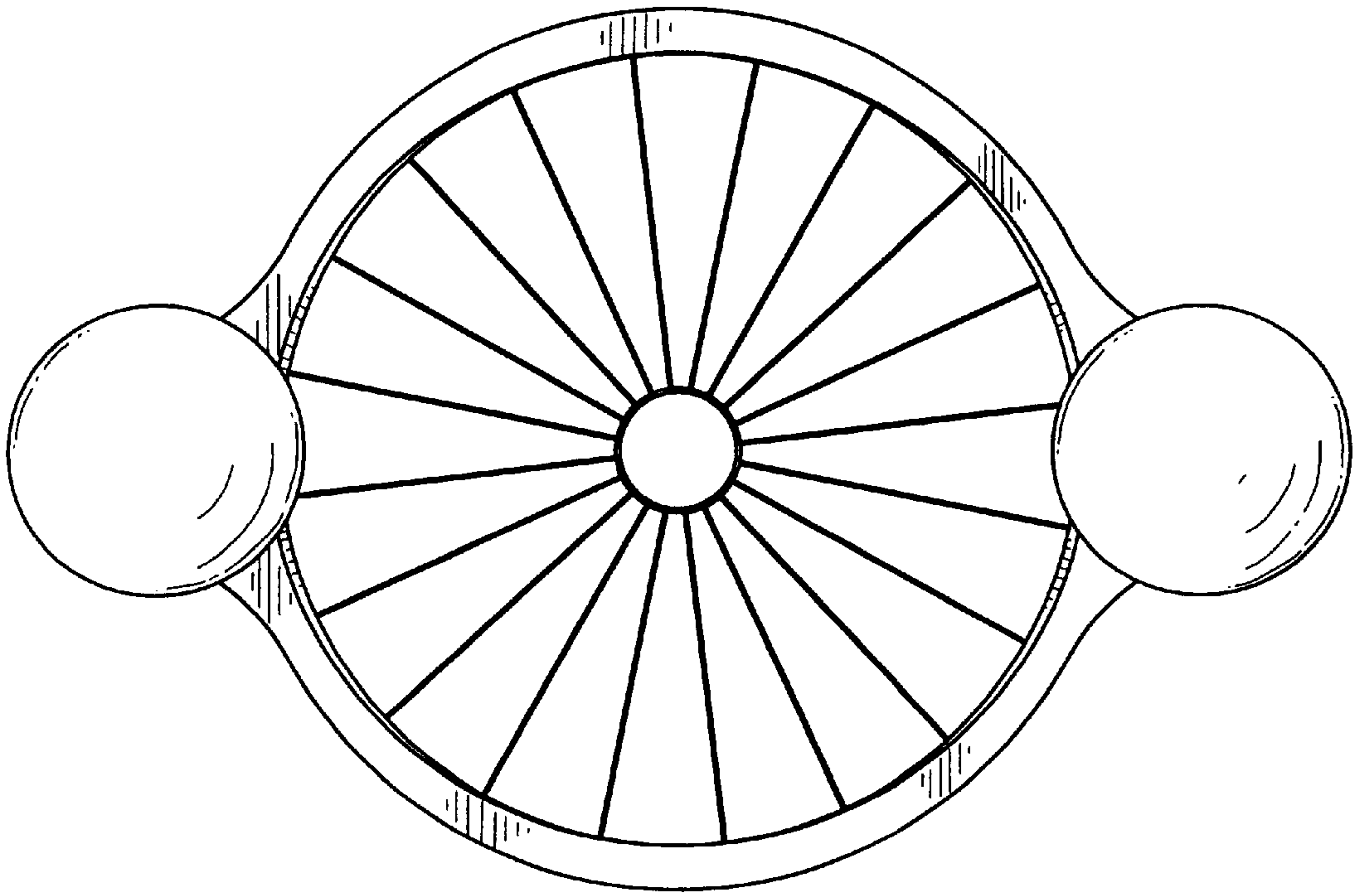

FIG. 9

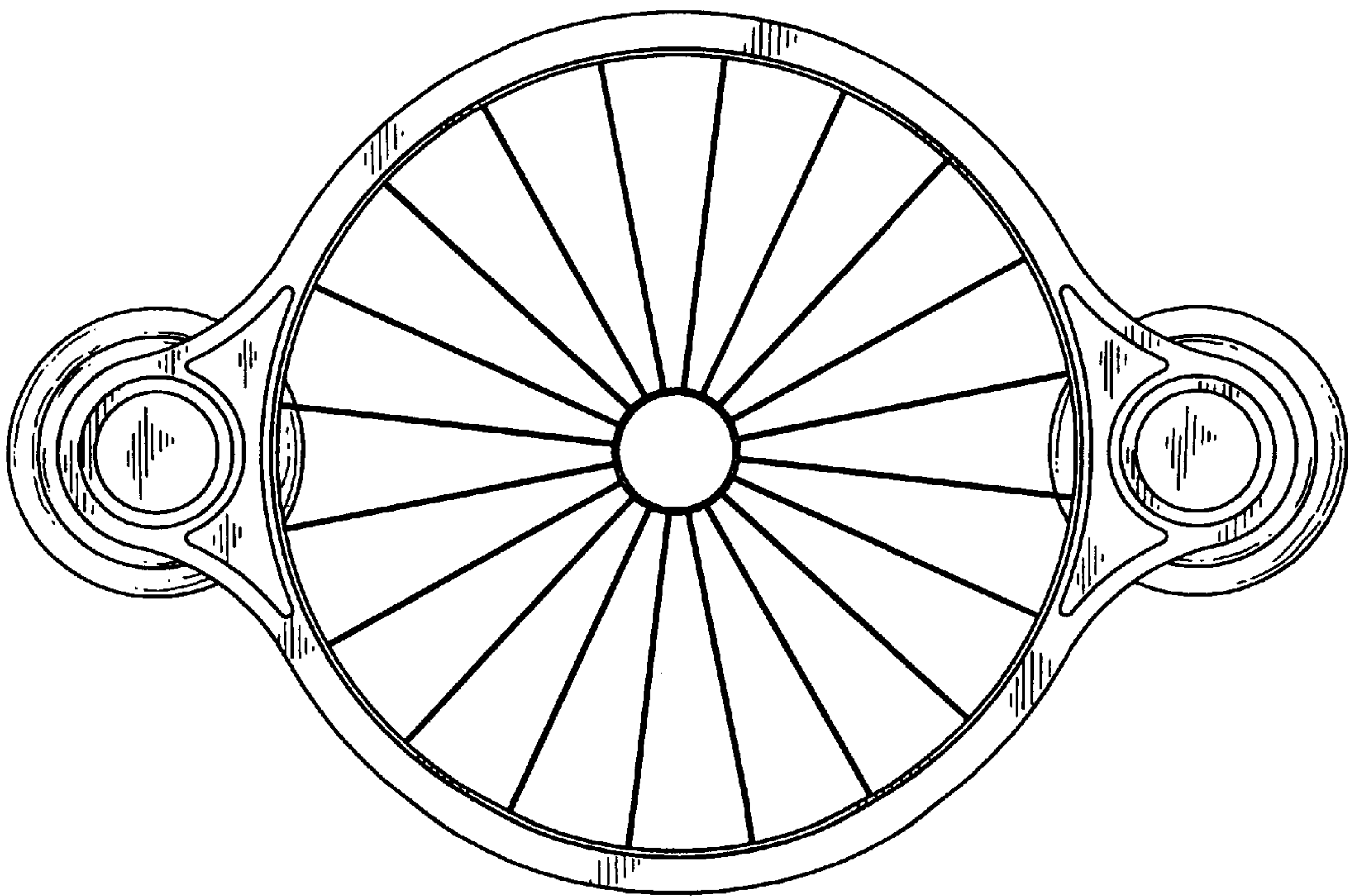

FIG. 12

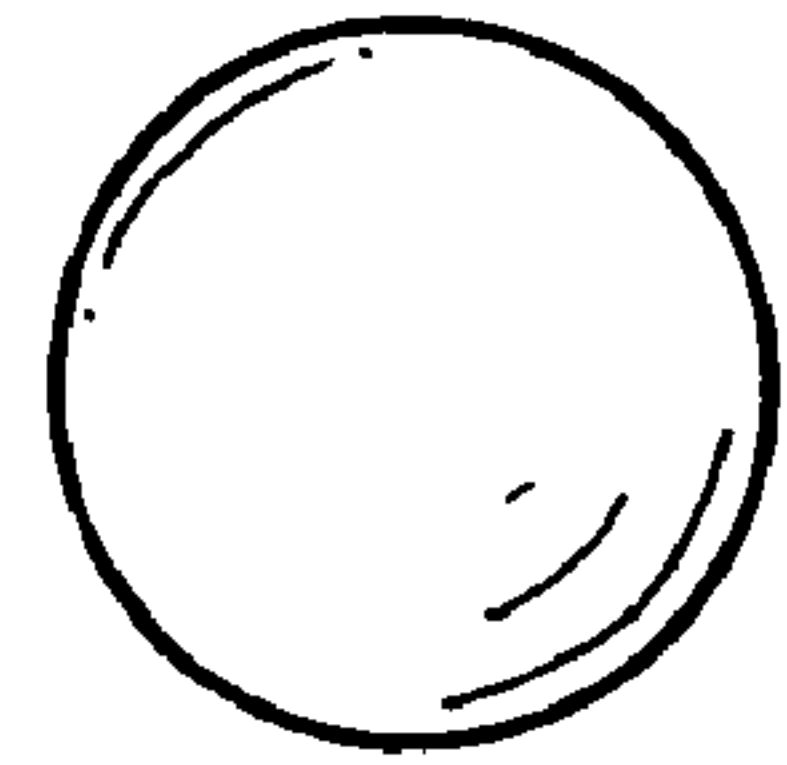

FIG. 10

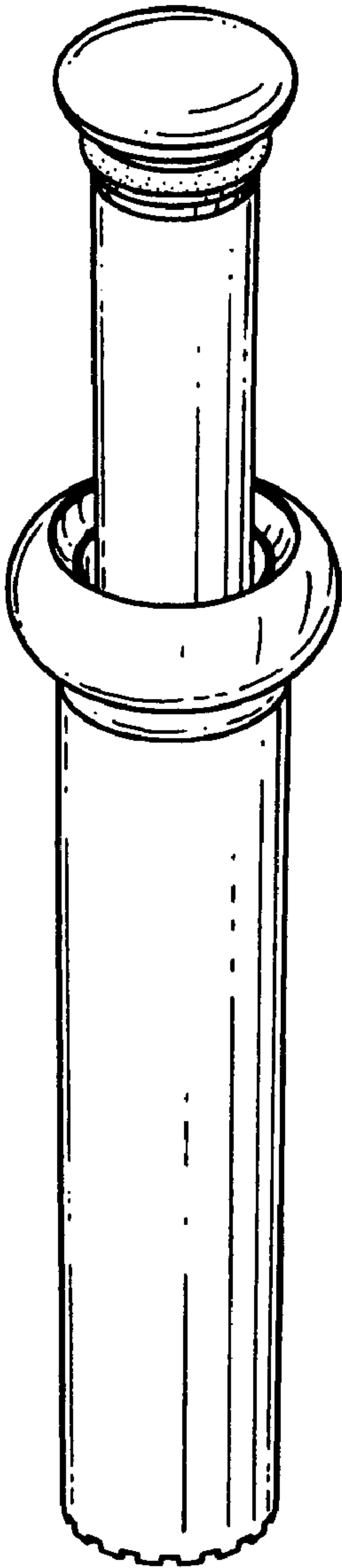

FIG. 11

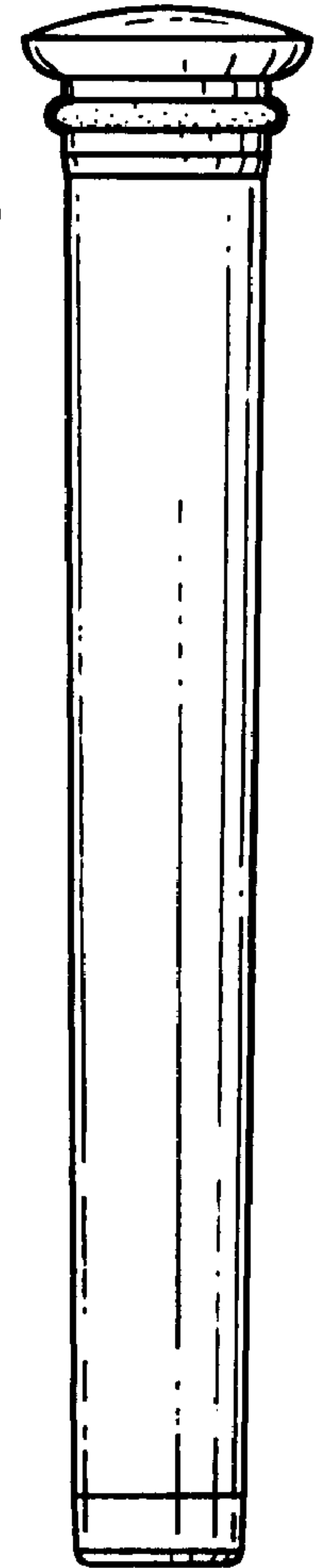

FIG. 13

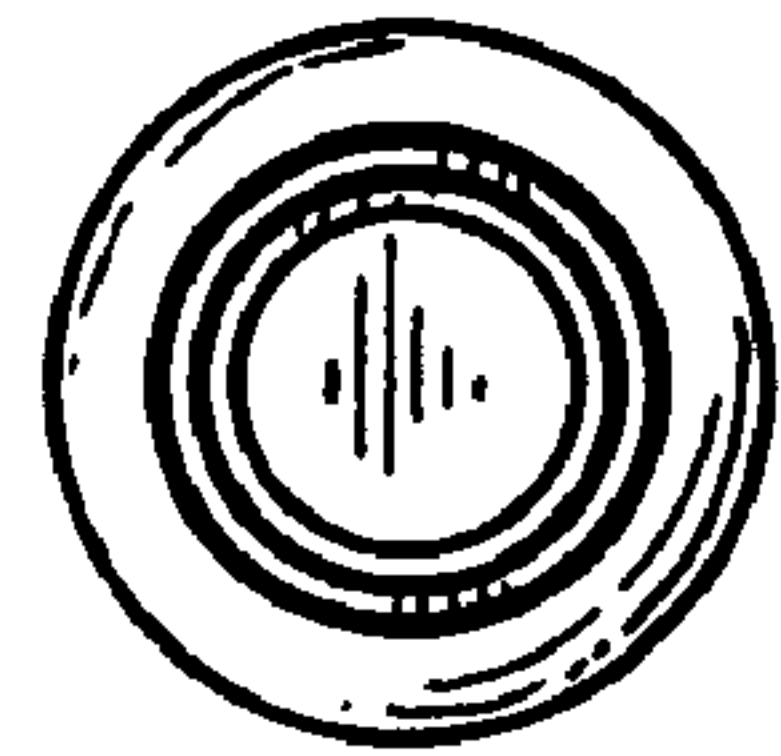

FIG. 15

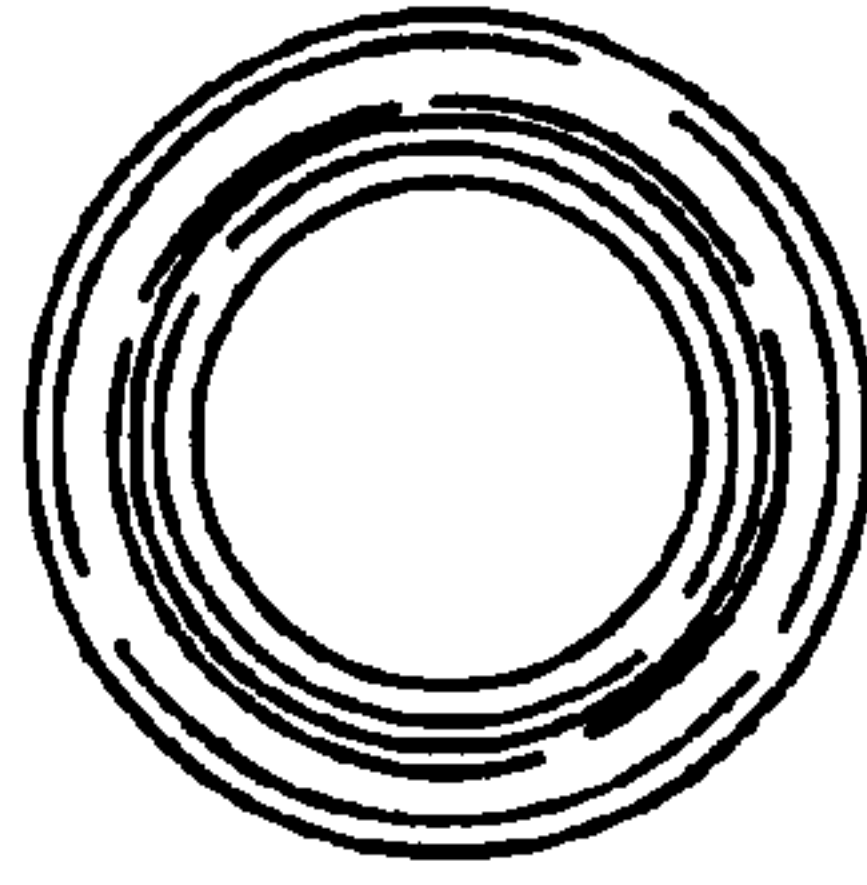

FIG. 14

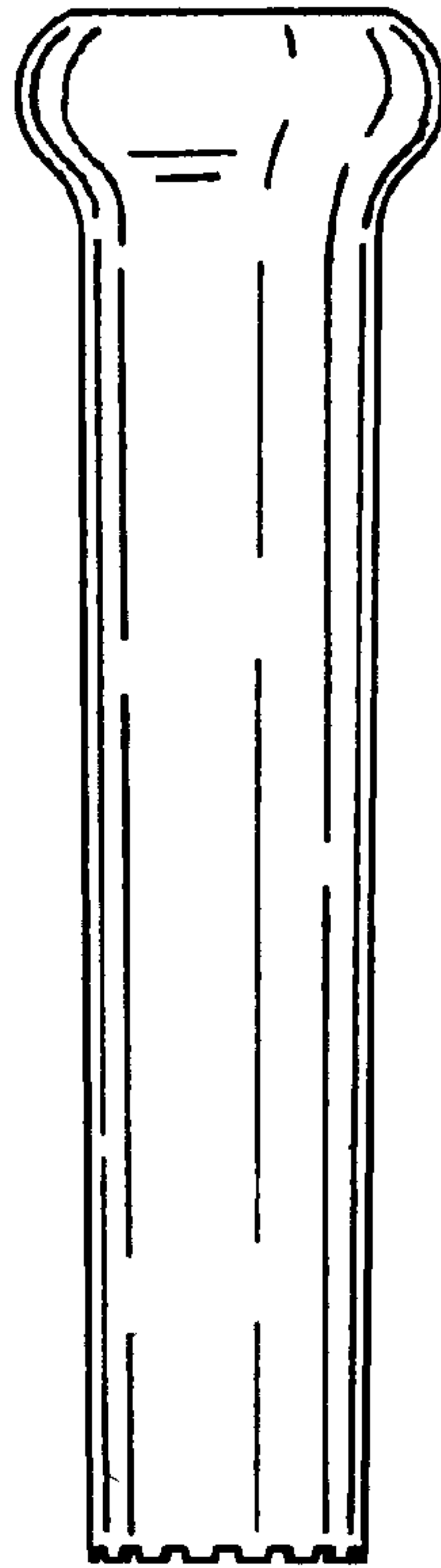

FIG. 16

