



US00D415788S

United States Patent [19]

Quijano et al.

[11] Patent Number: **Des. 415,788**

[45] Date of Patent: **** Oct. 26, 1999**

[54] **SET DOCUMENT FEEDER FOR A PRINTING MACHINE**

D. 404,421 1/1999 Takeuchi D18/49
4,955,595 9/1990 Kawano et al. 271/9

[75] Inventors: **David Quijano, Victor; Mark S. Penke**, West Henrietta, both of N.Y.

Primary Examiner—Caron D. Veynar
Attorney, Agent, or Firm—John S. Wagley

[73] Assignee: **Xerox Corporation**, Stamford, Conn.

[57] **CLAIM**

[**] Term: **14 Years**

The ornamental design for a set document feeder for a printing machine, as shown and described.

[21] Appl. No.: **29/096,129**

DESCRIPTION

[22] Filed: **Nov. 5, 1998**

FIG. 1 is a perspective view of a set document feeder for a printing machine showing our new design; FIG. 2 is a front elevational view thereof; FIG. 3 is right side elevational view thereof; FIG. 4 is rear elevational view thereof; FIG. 5 is left side elevational view thereof; and, FIG. 6 is a top plan view thereof.

[51] **LOC (6) Cl.** **18-99**

[52] **U.S. Cl.** **D18/49**

[58] **Field of Search** D18/46-49, 36-39, D18/56; 271/3.08, 3.14, 292, 9, 162; 399/16, 17, 361, 363-365

The broken line showing of a printing machine in FIGS. 1-6 is for illustrative purposes only and forms no part of the claimed design.

[56] **References Cited**

U.S. PATENT DOCUMENTS

D. 329,456 9/1992 Kamezaki D18/49
D. 404,065 1/1999 Nakamura D18/49

1 Claim, 6 Drawing Sheets

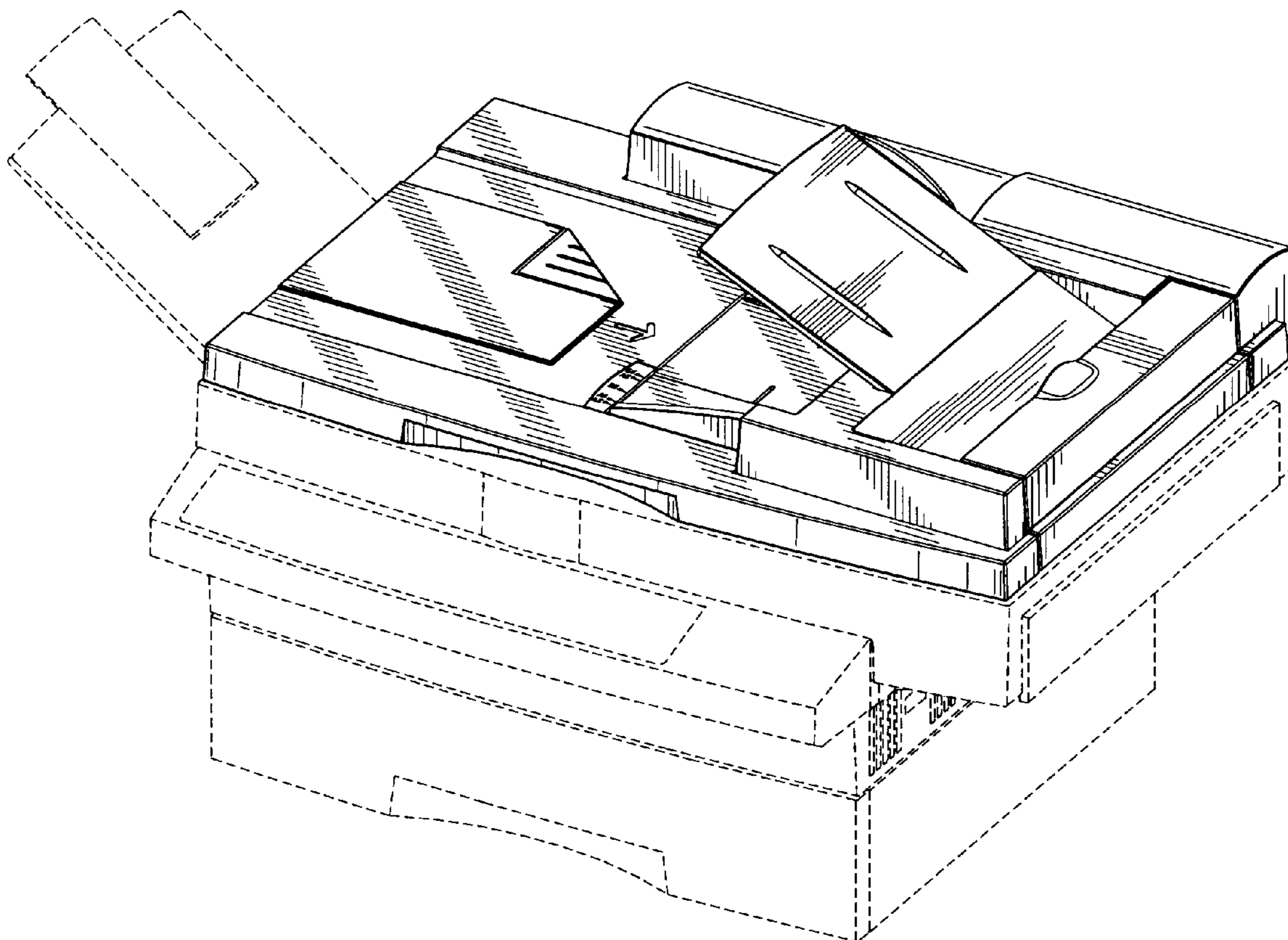

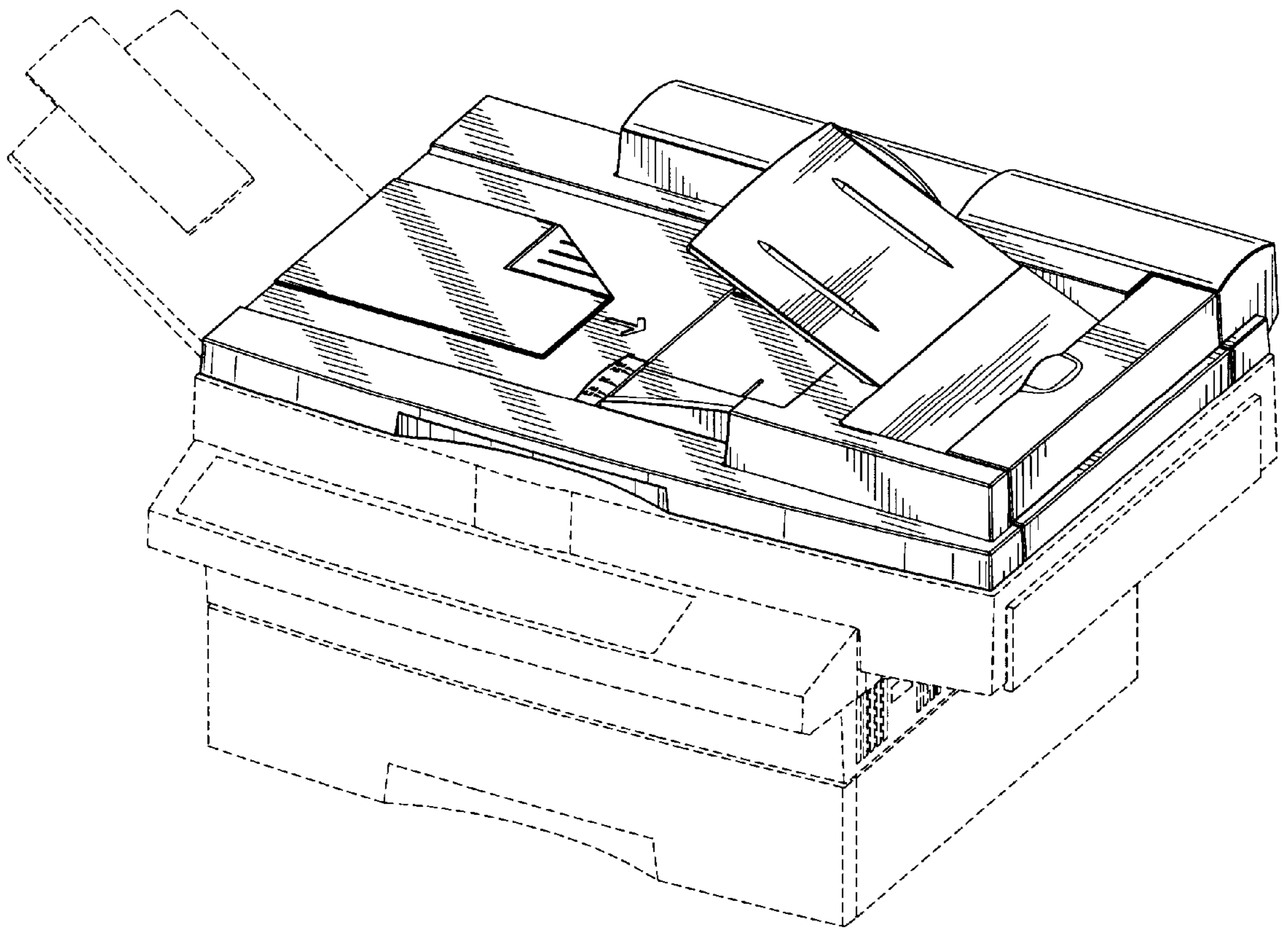

FIG. 1

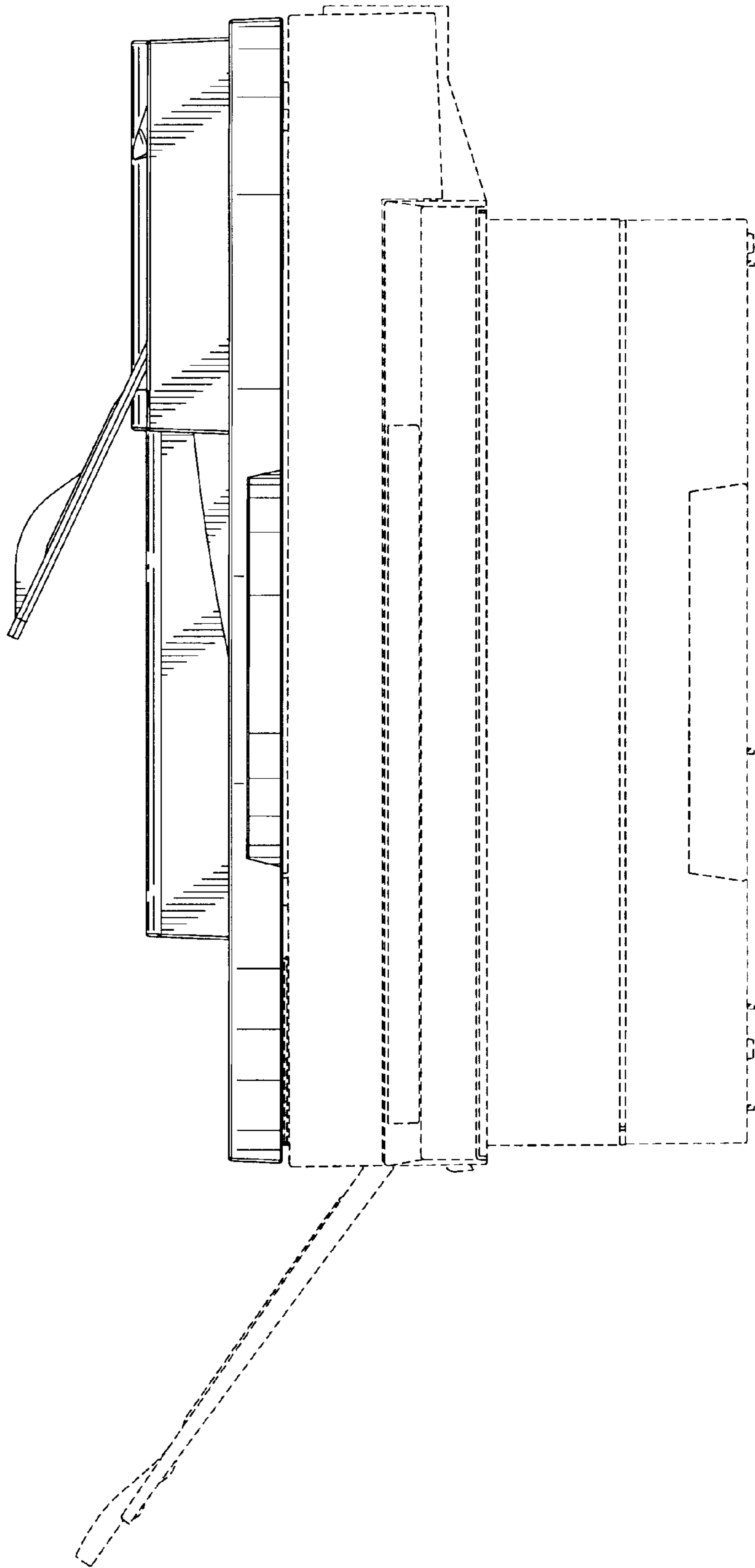

FIG. 2

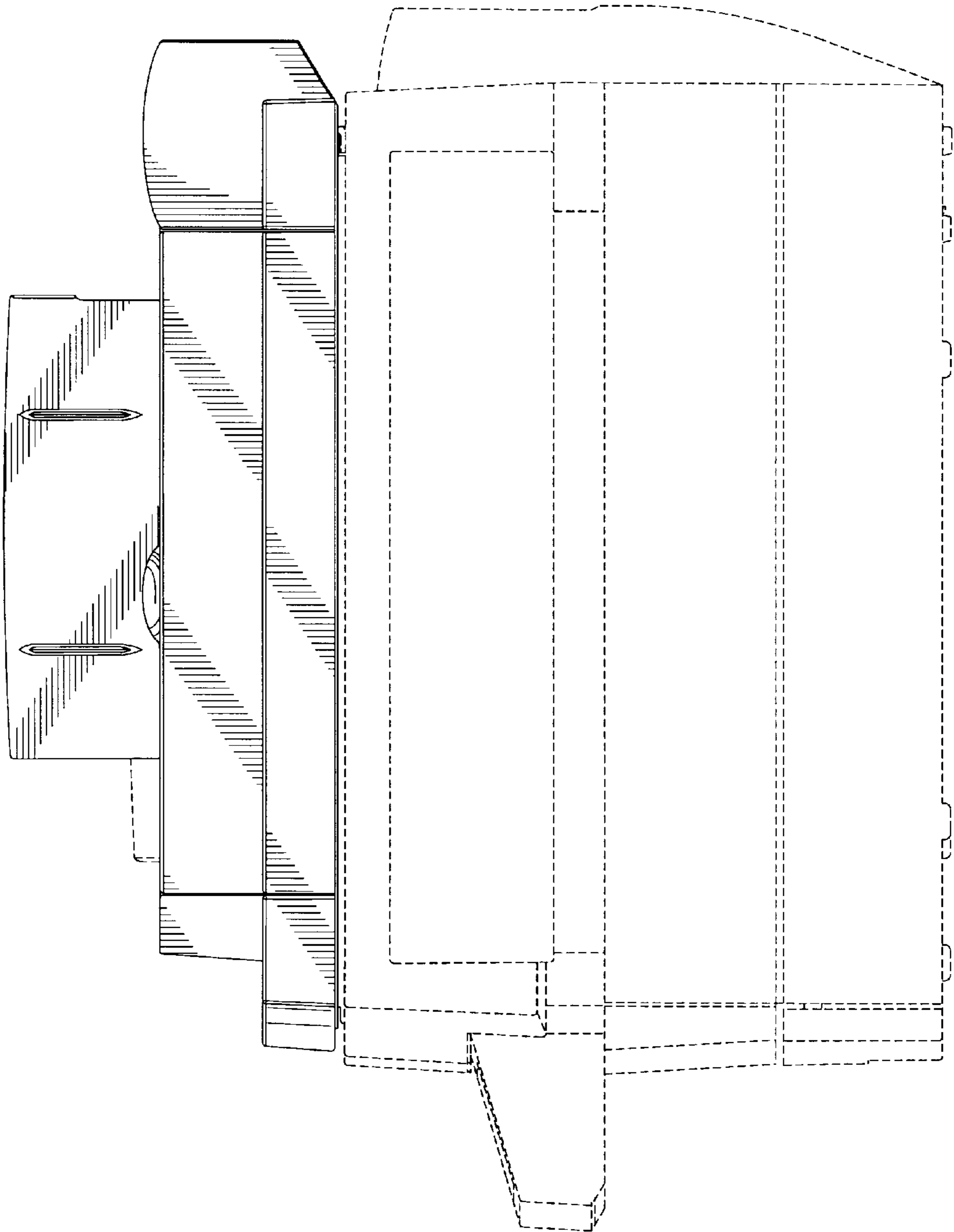

FIG. 3

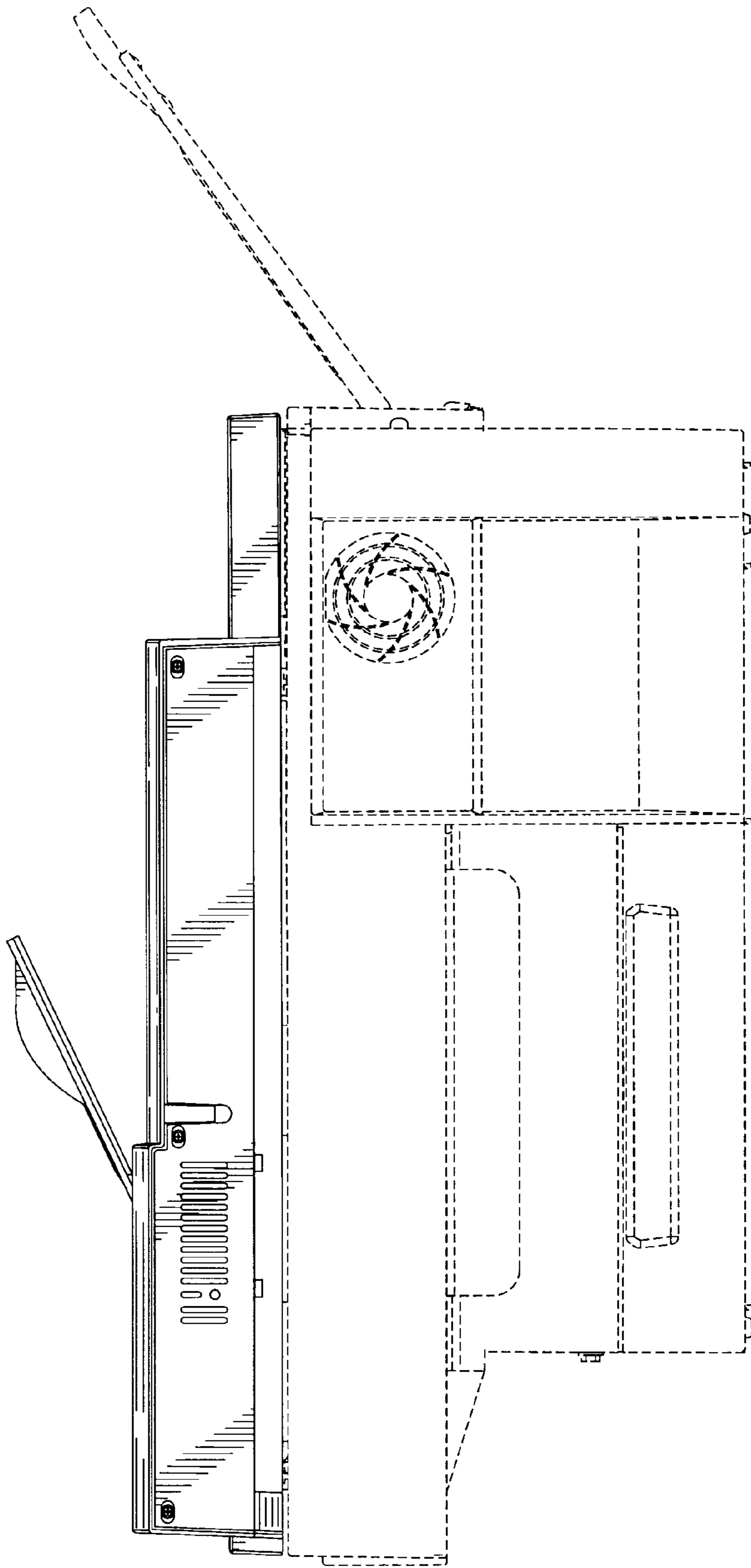

FIG. 4

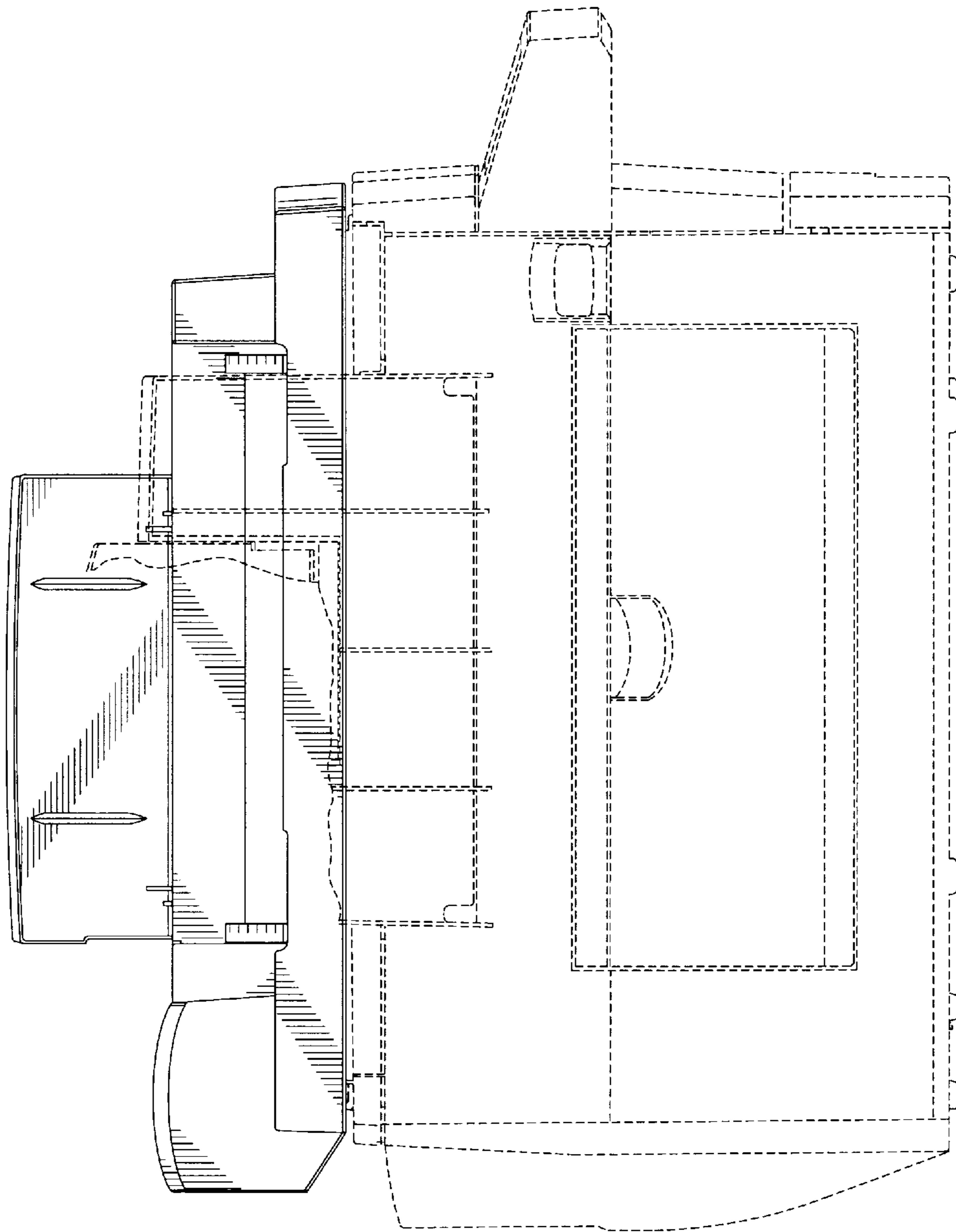

FIG. 5

