



US00D415772S

United States Patent [19] Hinspeger

[11] Patent Number: **Des. 415,772**

[45] Date of Patent: **** Oct. 26, 1999**

[54] **COLLAPSIBLE SHELTER**

[75] Inventor: **Peter Hinspeger**, Mississauga, Canada

[73] Assignee: **Hinspergers Poly Industries Ltd.**,
Mississauga, Canada

[**] Term: **14 Years**

[21] Appl. No.: **29/079,401**

[22] Filed: **Nov. 13, 1997**

3,227,484 1/1966 Merclean 296/79
 4,433,868 2/1984 Hochwitz et al. 296/79
 5,286,081 2/1994 Martin, Jr. 296/102

Primary Examiner—Sandra L. Morris
Attorney, Agent, or Firm—McFadden, Fincham

[57] CLAIM

The ornamental design for a collapsible shelter, as shown and described.

DESCRIPTION

FIG. 1 is a rear perspective view of a collapsible shelter, showing my new design;
 FIG. 2 is a front elevational view of the design of FIG. 1;
 FIG. 3 is a rear elevational view of the design;
 FIG. 4 is a side elevational view of the design;
 FIG. 5 is a side elevational view of the opposite side of the design;
 FIG. 6 is a top plan view of the design;
 FIG. 7 is a bottom plan view of the design;
 FIG. 8 is a perspective view of the design; and,
 FIG. 9 is a perspective view of the design in use, the broken line showing is for illustrative purposes only, and forms no part of the claimed design.
 FIGS. 2-9 are shown on a reduced scale.

Related U.S. Application Data

[63] Continuation-in-part of application No. 29/074,690, Jul. 28, 1997.

[51] **LOC (6) Cl.** **15-03**

[52] **U.S. Cl.** **D15/11; D15/30**

[58] **Field of Search** D15/10-12, 22-26,
D15/30; D21/837; D25/16; 180/89.1, 89.12,
89.13; 296/79, 102

References Cited

U.S. PATENT DOCUMENTS

D. 237,996 12/1975 Pierre D15/30
 D. 273,494 4/1984 Hurlburt et al. D15/30

1 Claim, 4 Drawing Sheets

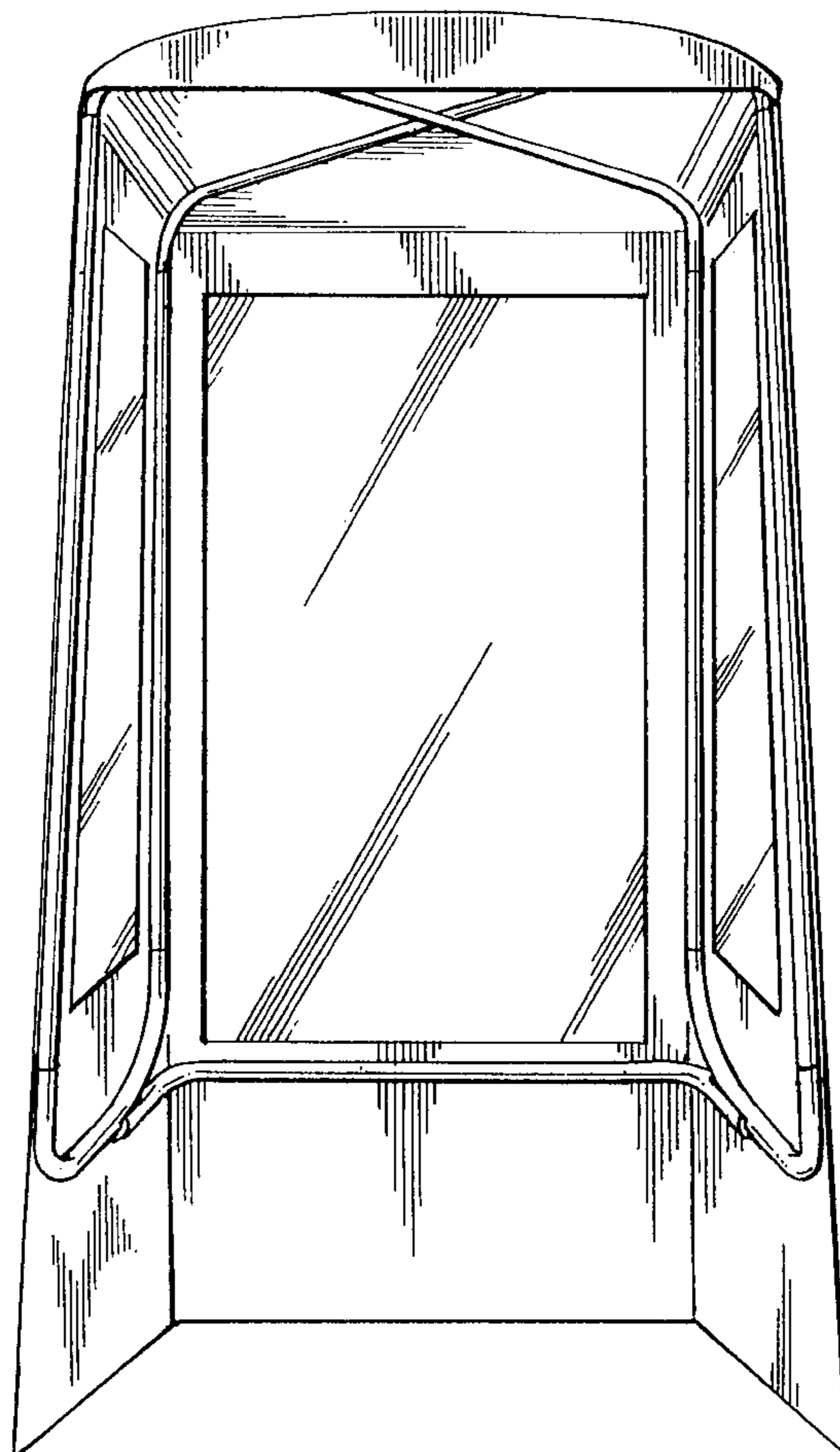

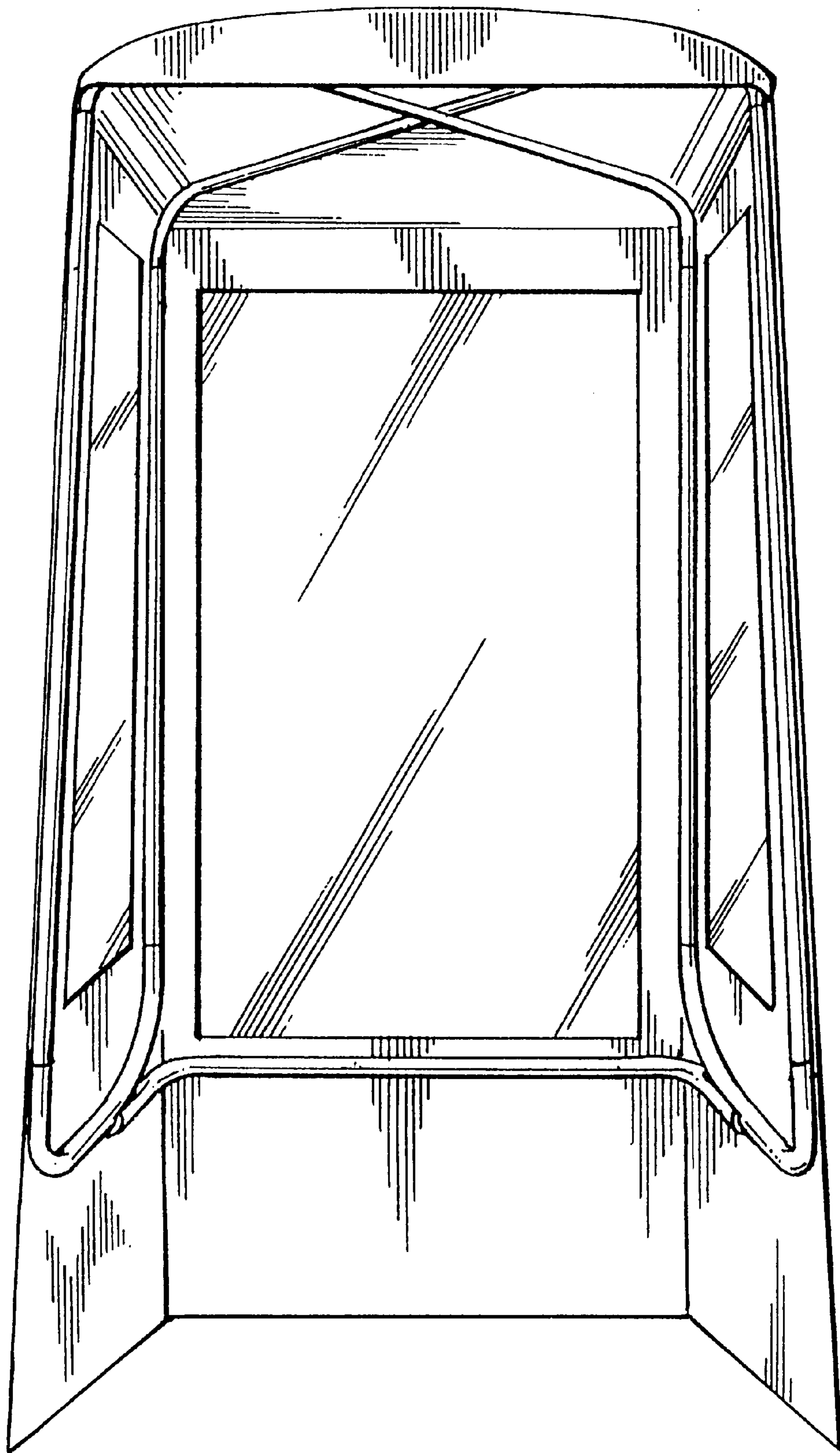

FIG. 1

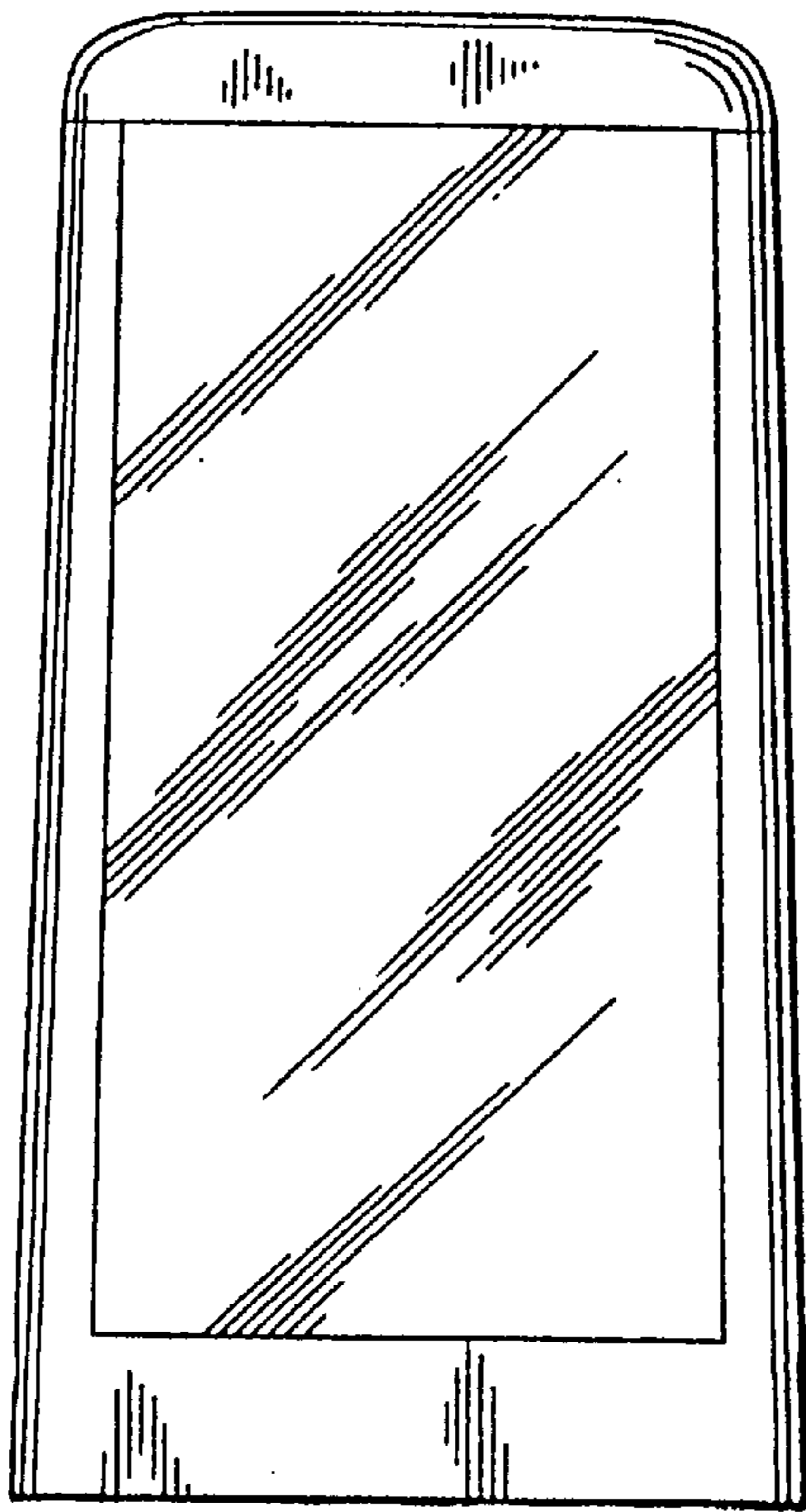

FIG. 2

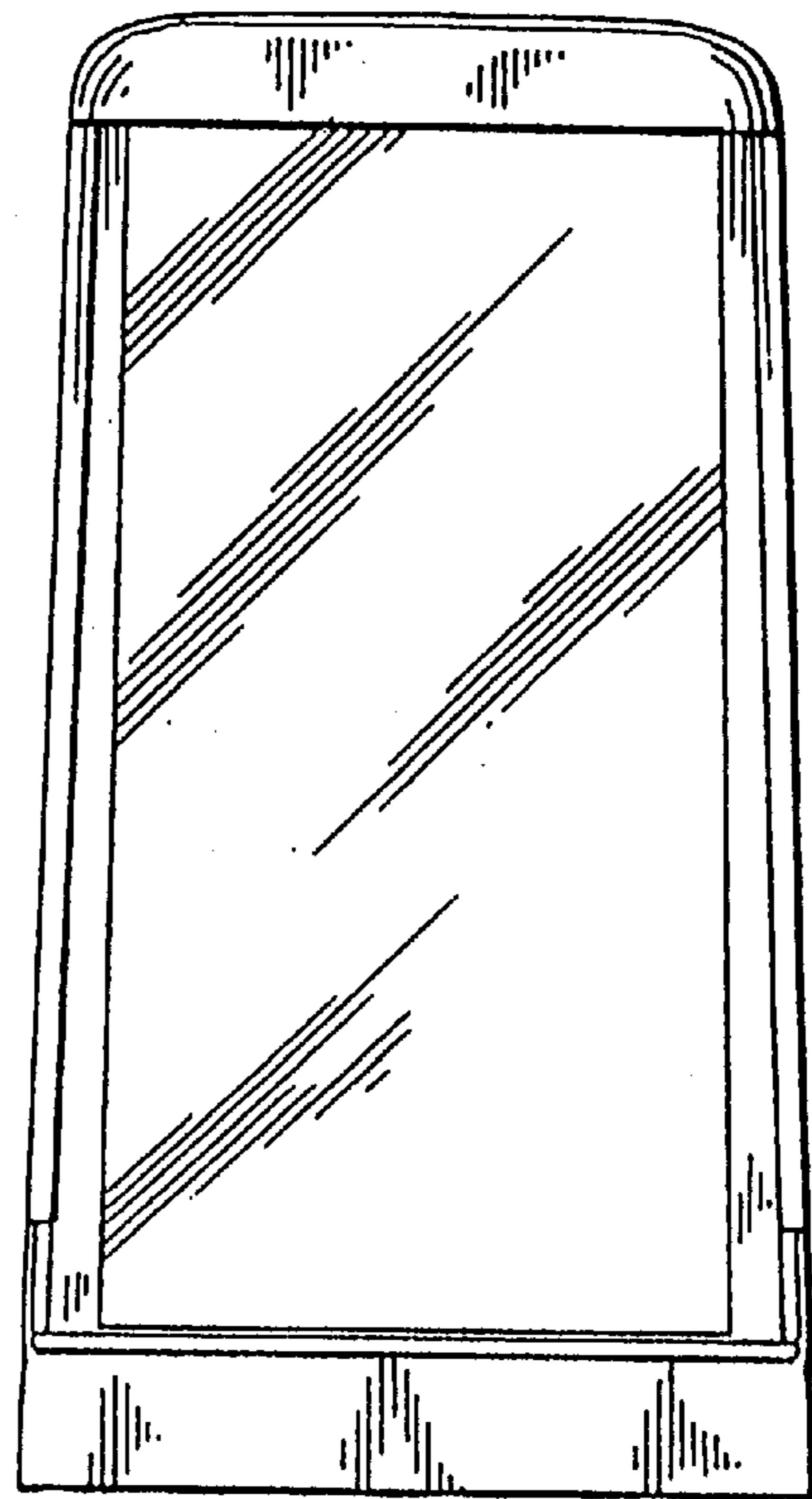

FIG. 3

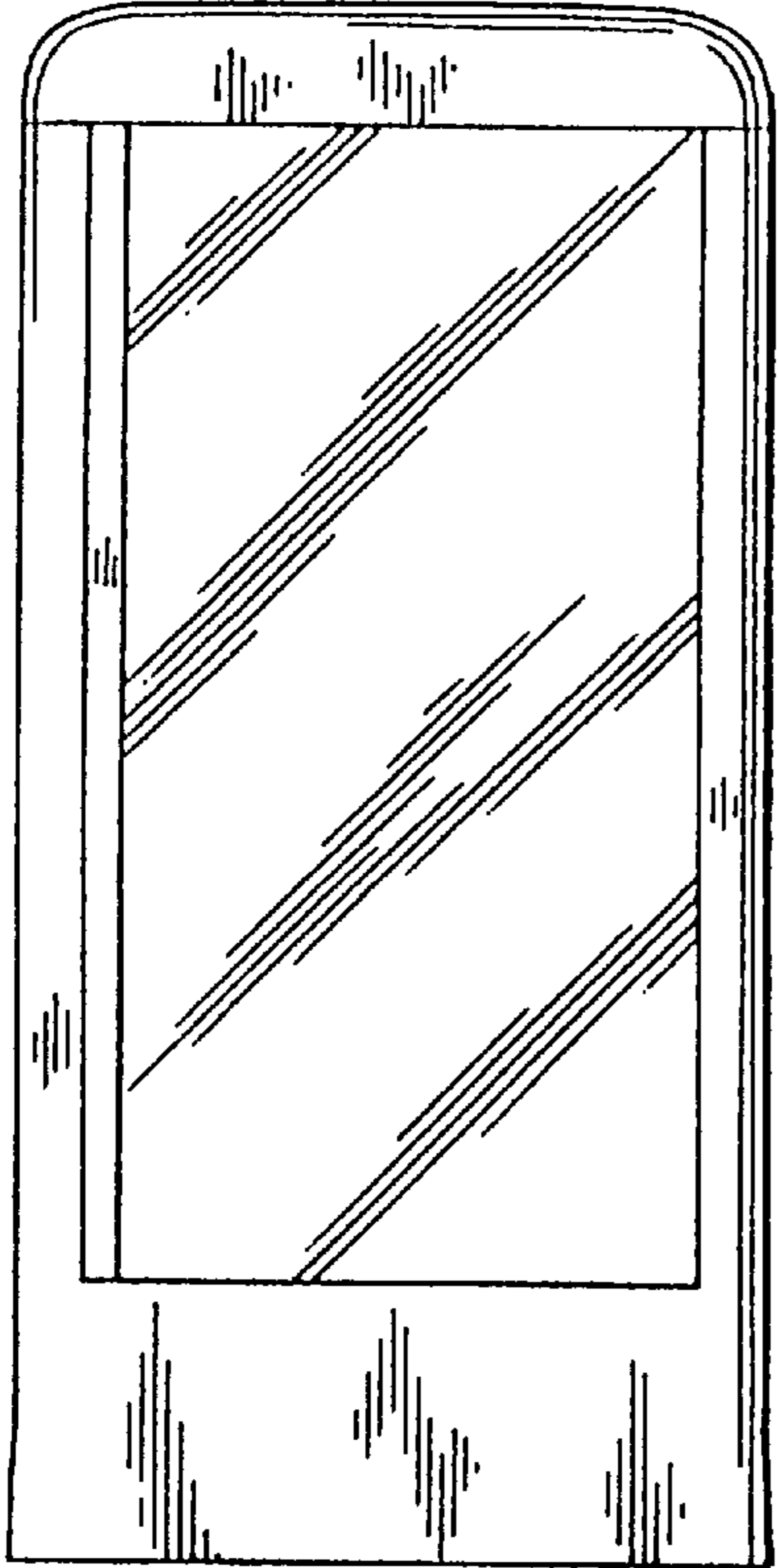

FIG. 4

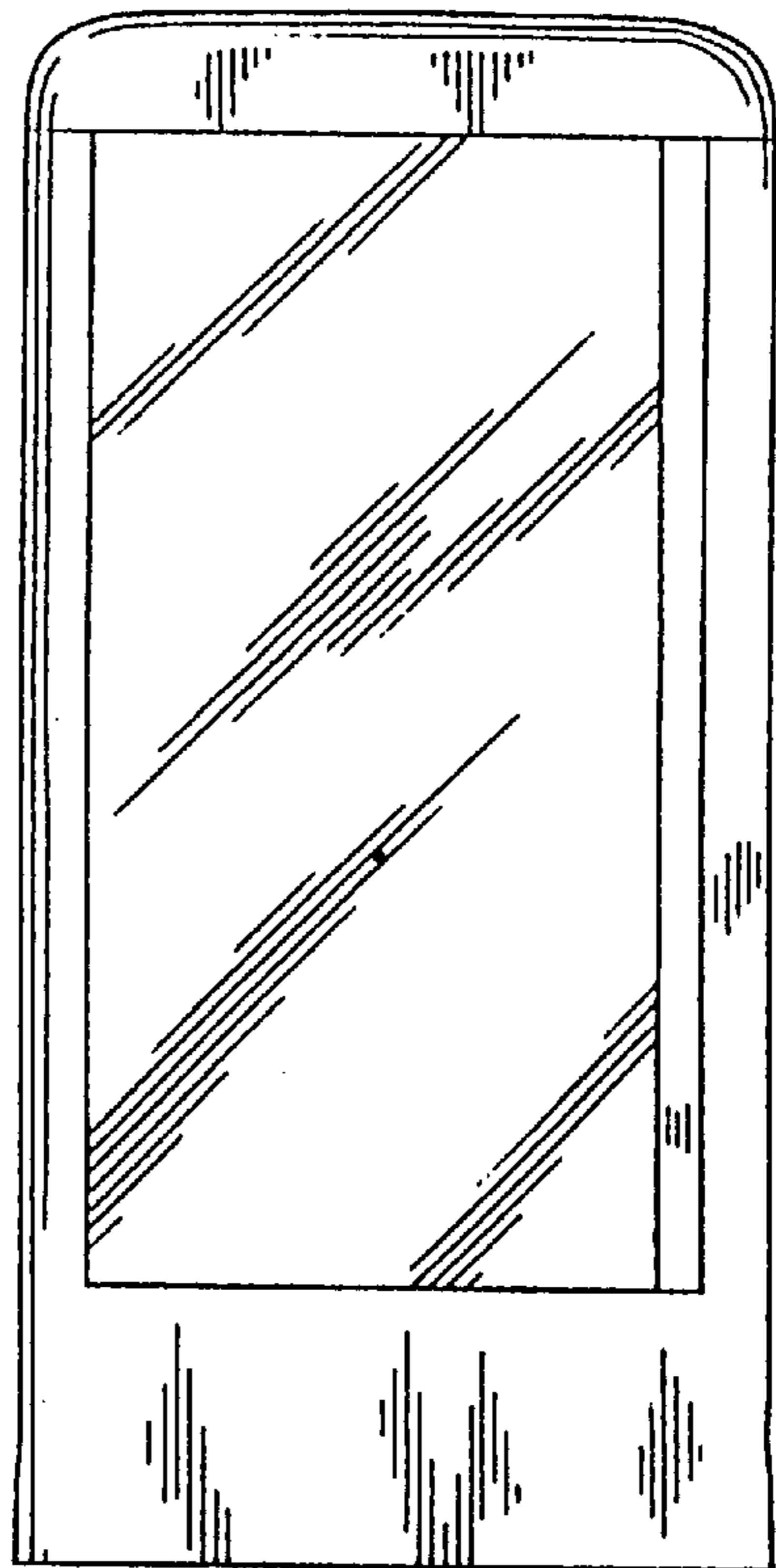

FIG. 5

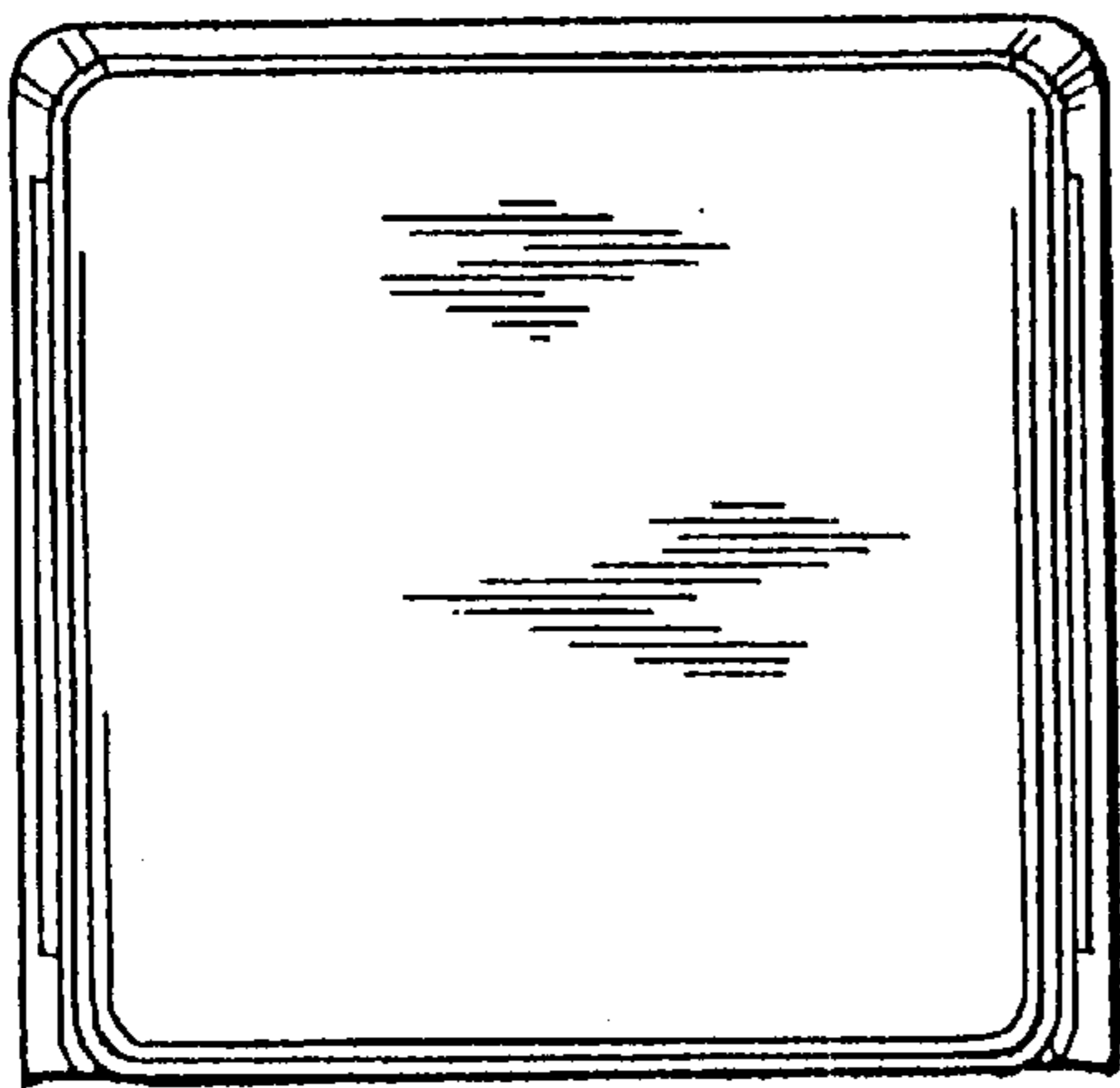

FIG. 6

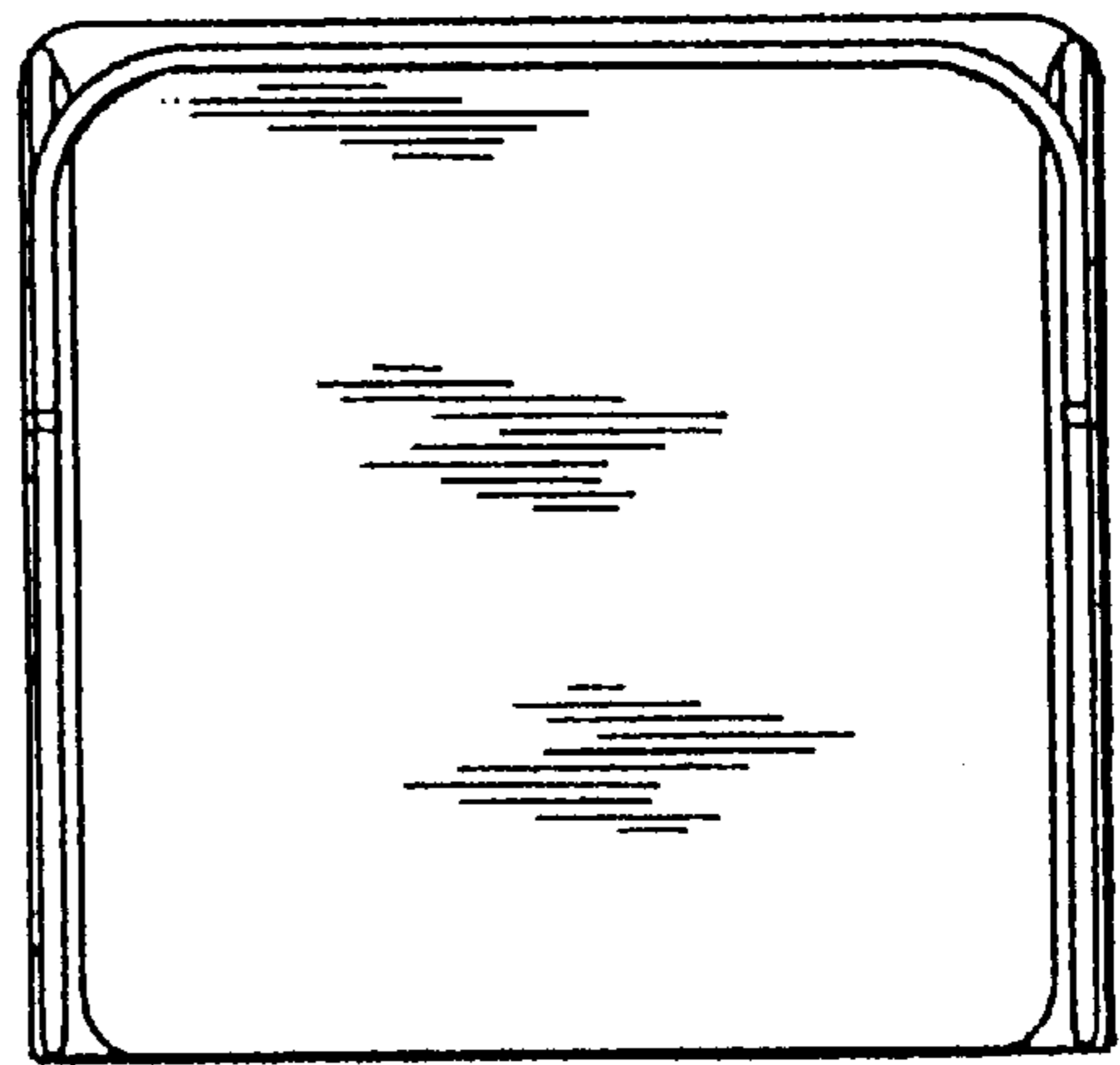

FIG. 7

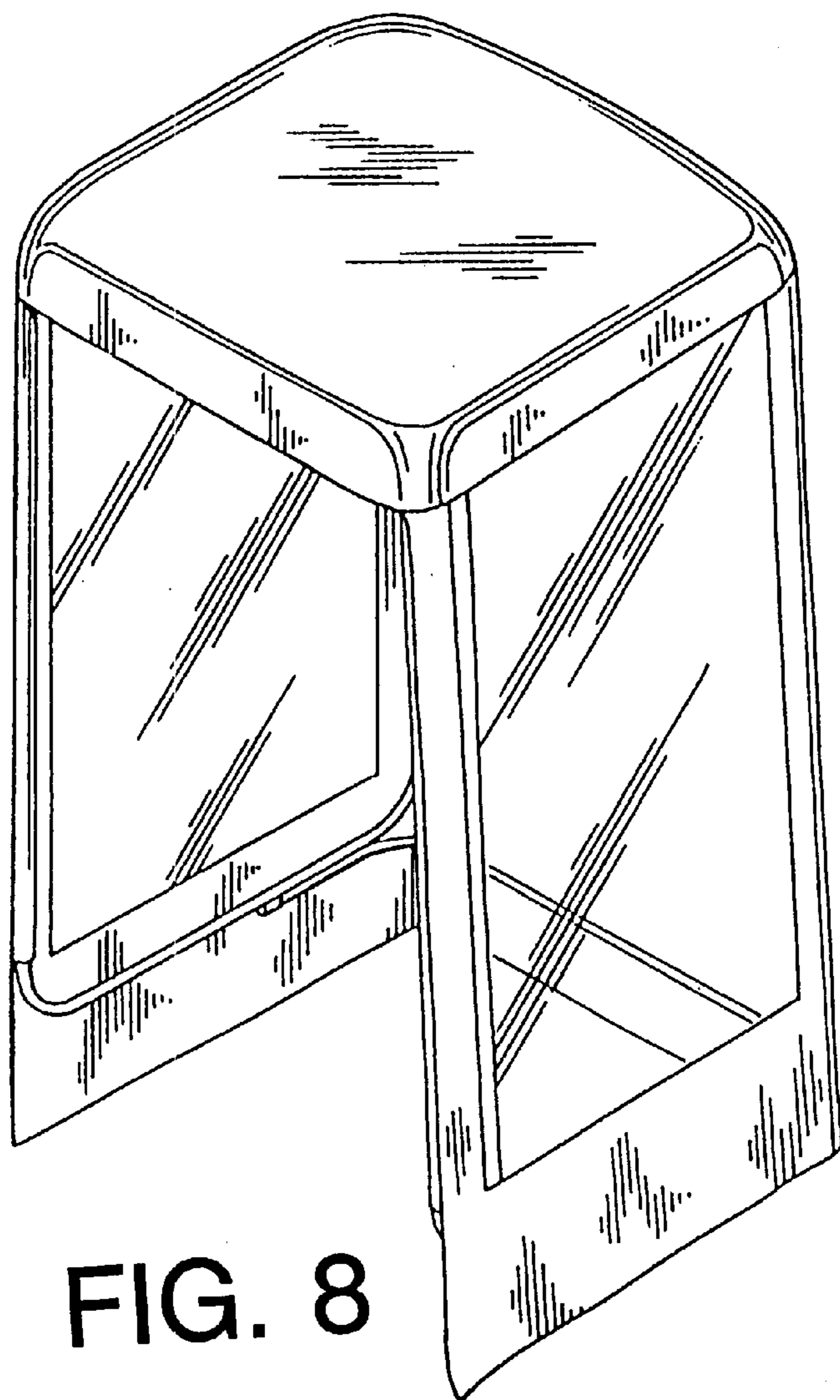

FIG. 8

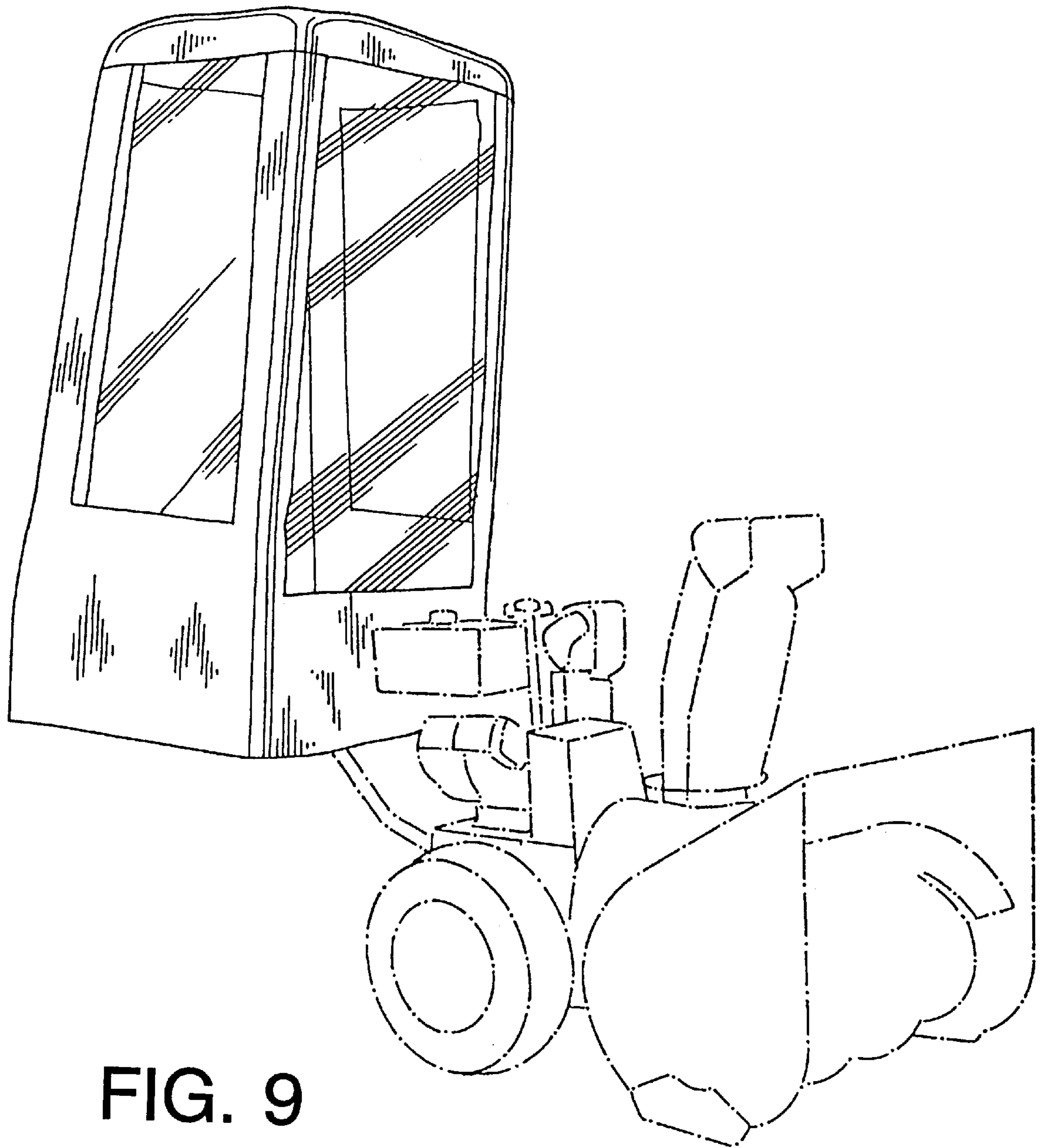

FIG. 9