



US00D415697S

United States Patent [19]
Kaneko

[11] **Patent Number: Des. 415,697**

[45] **Date of Patent: ** Oct. 26, 1999**

[54] **WRIST WATCH**

2,189,096 2/1940 Alonge .
2,952,967 9/1960 Nussle .

[75] Inventor: **Kunio Kaneko**, Paris, France

[73] Assignee: **Seiko Kabushiki Kaisha**, Tokyo, Japan

[**] Term: **14 Years**

Primary Examiner—Nelson C. Holtje
Attorney, Agent, or Firm—Stroock & Stroock & Lavan LLP

[21] Appl. No.: **29/094,042**

[22] Filed: **Sep. 24, 1998**

[57] **CLAIM**

The ornamental design for a wrist watch, as shown and described.

[30] **Foreign Application Priority Data**

Mar. 24, 1998 [JP] Japan 10-8232

[51] **LOC (6) Cl.** **10-02**

[52] **U.S. Cl.** **D10/32**

[58] **Field of Search** D10/1-40, 122-132;
D11/3-25; 63/1.1, 3, 5, 11; 368/276-277,
280-282, 285

DESCRIPTION

FIG. 1 is a perspective view of the wrist watch in accordance with the present invention;
FIG. 2 is a front elevational view of the wrist watch;
FIG. 3 is a rear elevational view of the wrist watch;
FIG. 4 is a cross-sectional view of the wrist watch taken along line 4-4 in FIG. 2;
FIG. 5 is a top plan view of the wrist watch;
FIG. 6 is a bottom plan view of the wrist watch;
FIG. 7 is a left side view of the wrist watch; and,
FIG. 8 is a right side view of the wrist watch.

[56] **References Cited**

U.S. PATENT DOCUMENTS

D. 123,814 12/1940 Megur .

1 Claim, 2 Drawing Sheets

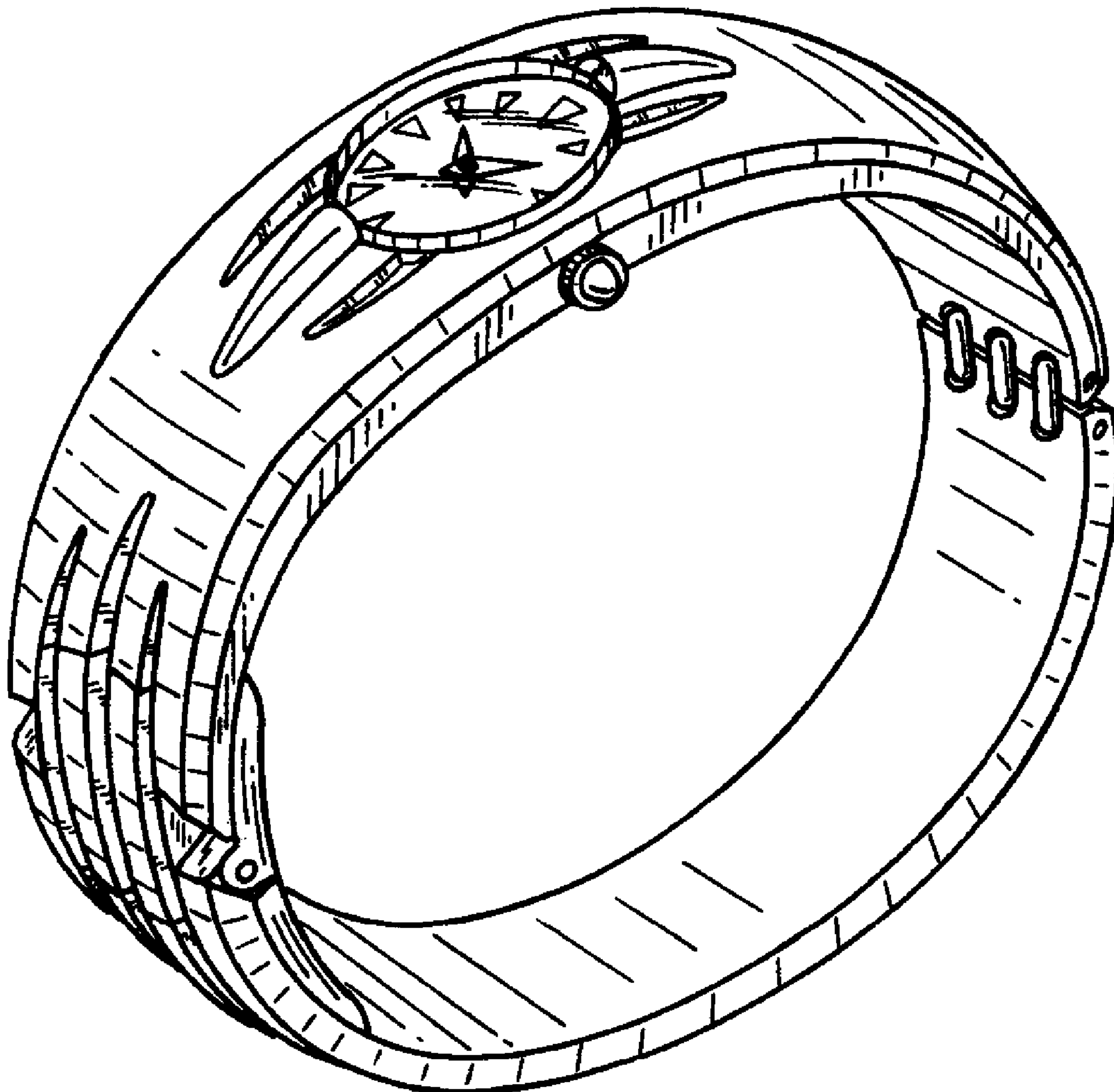

FIG. 1

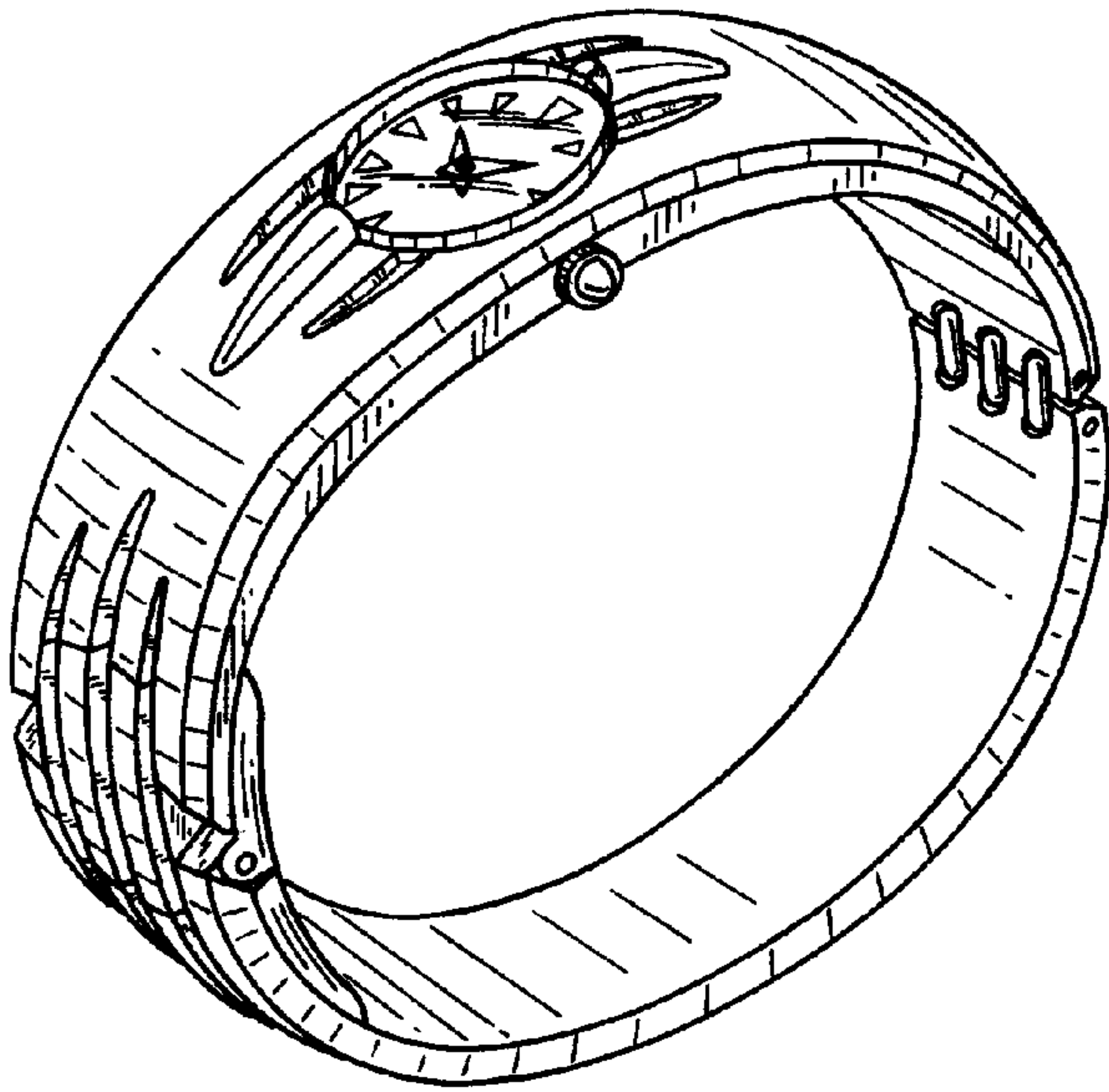

FIG. 2

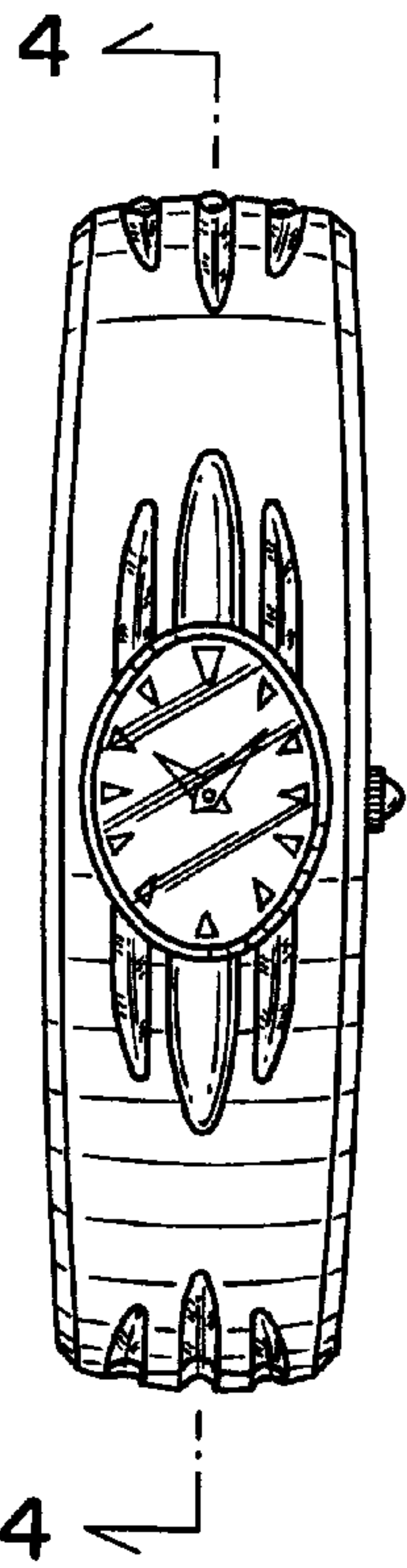

FIG. 3

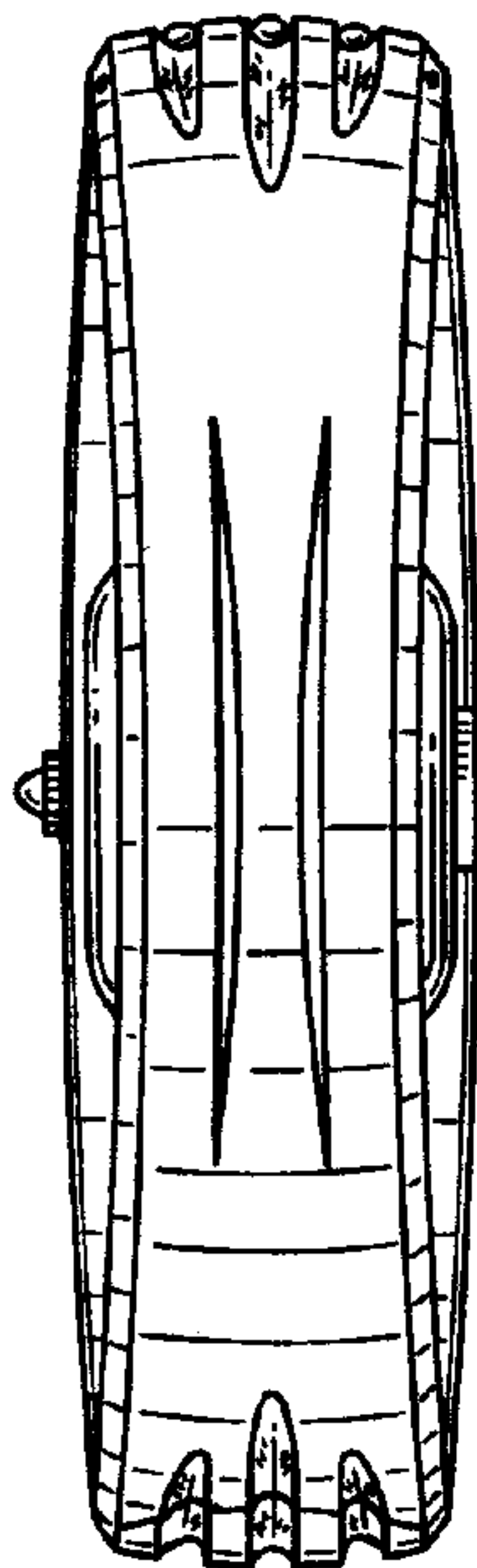

FIG. 4

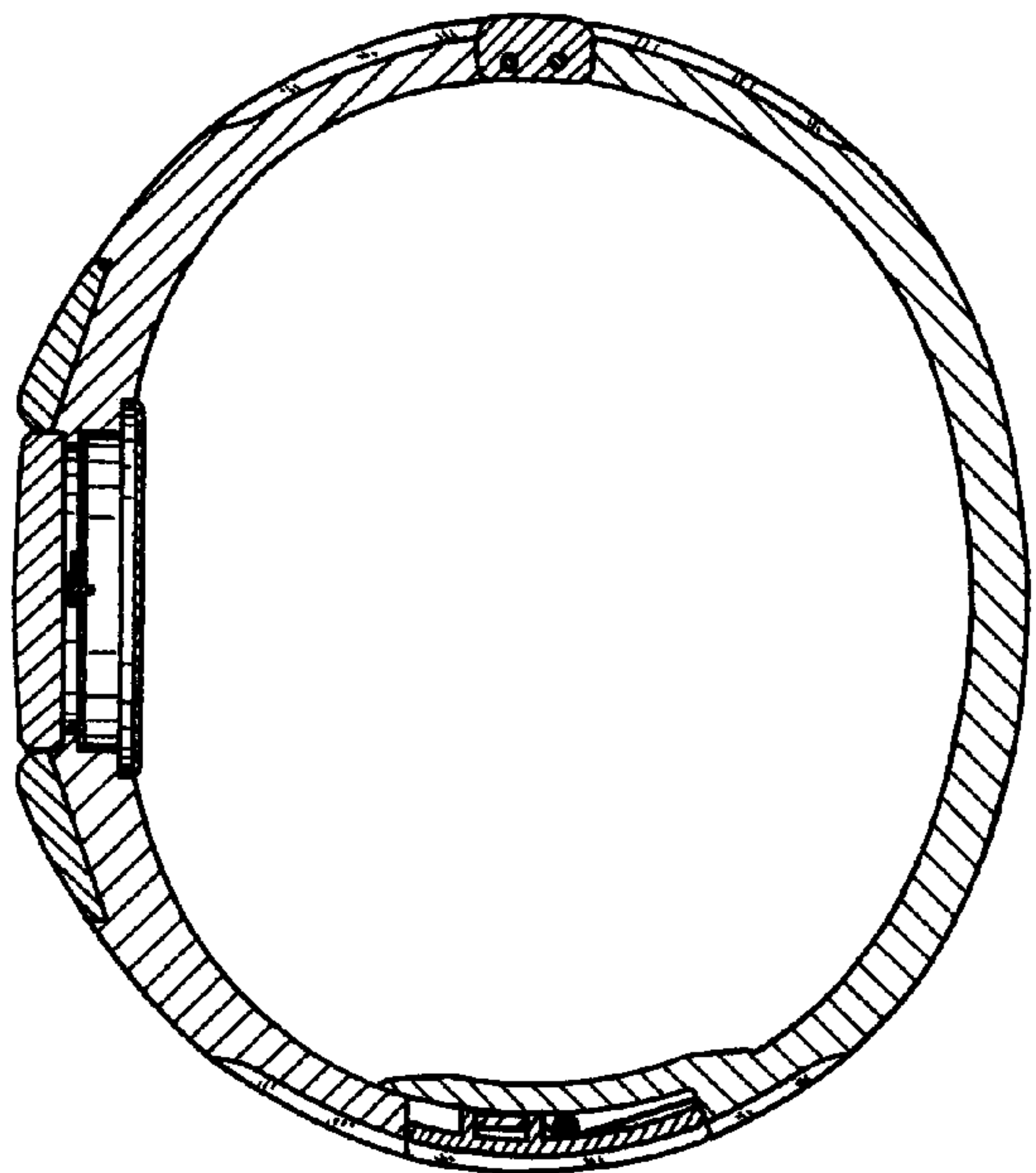

FIG. 5

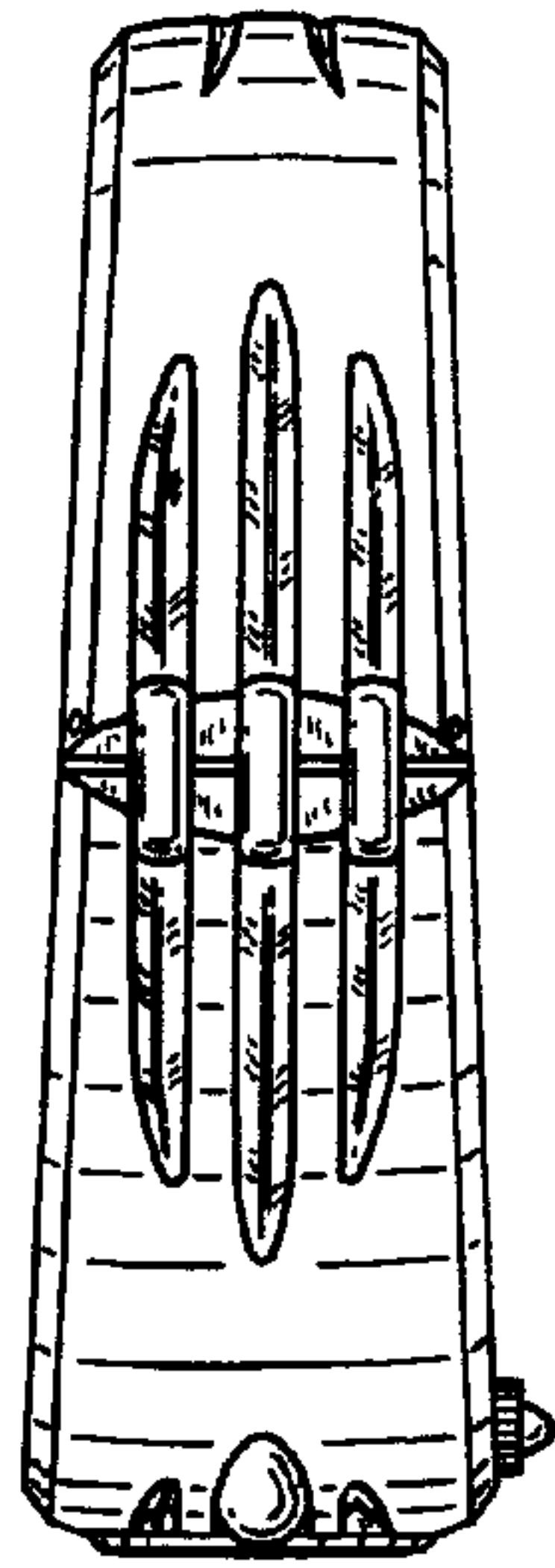

FIG. 6

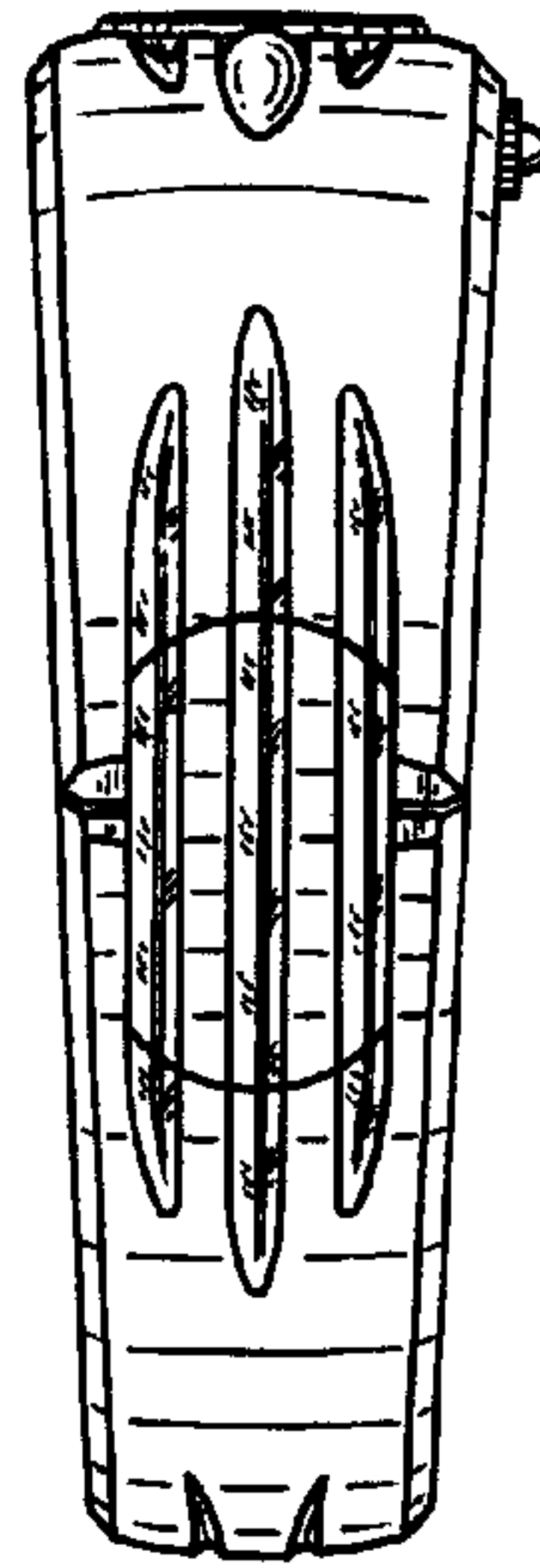

FIG. 7

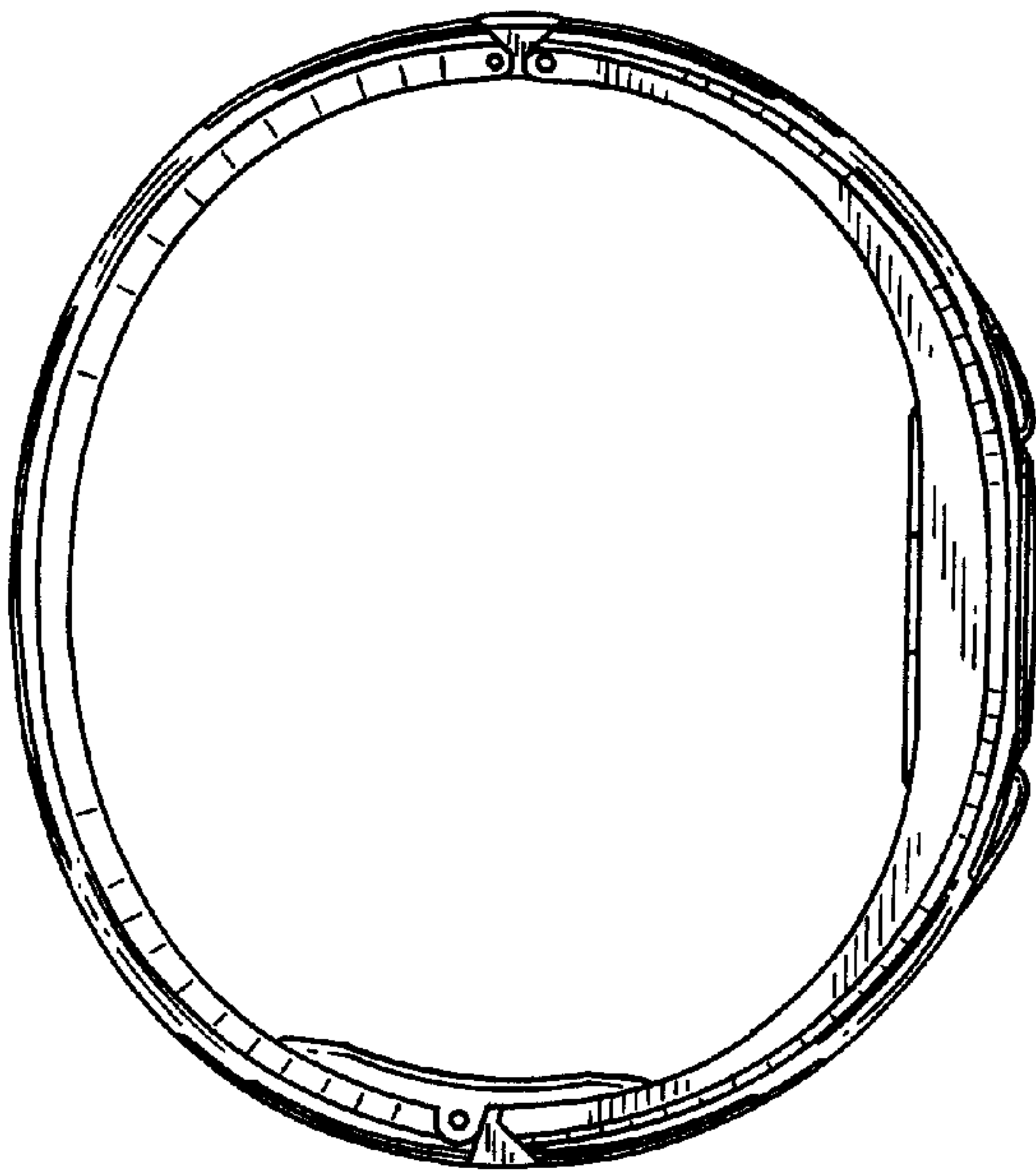

FIG. 8

